

interference^{ITEM™} technology

THE INTERNATIONAL JOURNAL OF
ELECTROMAGNETIC COMPATIBILITY™

2012 EMC DIRECTORY & DESIGN GUIDE

FEATURED TOPICS

TEST INSTRUMENTATION	10
TESTING	24
AMPLIFIERS / ANTENNAS	46
FILTERS / FERRITES	56
CABLES / CONNECTORS	80
SHIELDING	82
SURGE & TRANSIENTS	94
DESIGN	104

DIRECTORIES

CALENDAR	118
STANDARDS RECAP	122
PROFESSIONAL SOCIETIES	130
GOVERNMENT DIRECTORY	136
PRODUCTS & SERVICES INDEX	142
COMPANY DIRECTORY	151

**HF CURRENT PROBE:
THEORY AND APPLICATION**

All you need in one small package



Antennas | Probes | Accessories | Preamplifiers | Low-Loss Cables | Recalibration Services



Travel Made Easy

with Next-Day,
On-Time
Delivery

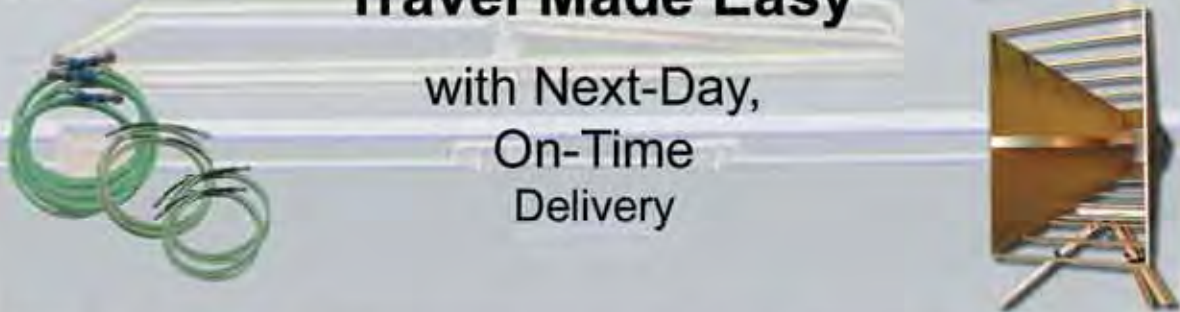

Don't Leave home without it. A.H. Systems provides many models of Portable Antenna Kits, each containing all the necessary Antennas, Current Probes, and Cables to satisfy numerous customer requirements. Excellent performance, portability (compact size and lightweight), along with ease of setup make all of the Antenna Kits your choice for indoor or field testing. Loss and breakage are virtually eliminated as each component has a specific storage compartment within the case. All Antenna Kits are accompanied with a Tripod and Azimuth & Elevation Head, both contained in a

ANTENNAS... Tripod Carrying Case...and don't forget your keys! **and KITS TOO...**



Innovation Quality Performance

Phone: (818)998-0223 • Fax (818)998-6892
www.AHSystems.com?IT

A.H. Systems



Engineering the most comprehensive network of commercial test laboratories in North America.

That's just one way that NTS works for your success.



At NTS, our heritage lies in the testing and certifications business. Over the last 50 years, through a combination of acquisitions, innovations and organic growth we have become the largest commercial test laboratory network in North America. Our testing capabilities span a very wide spectrum, covering Environmental, Dynamics, EMC, Wireless, Product Safety, Reliability, Quality Assurance, Ballistics and more. Our nationwide network of test laboratories is tied together through our LabInsight customer portal, which enables real-time witnessing and participation in testing programs taking place simultaneously at multiple NTS locations. Simply put, no other commercial test lab in North America can match our capacity and capabilities, which means we get you from test lab to market in the shortest possible time and with the least amount of effort, because helping you achieve your goals is how we achieve ours.



NTS

WE ENGINEER SUCCESS

10 TEST INSTRUMENTATION**Test Instrumentation Products & Services Index..... 10****The HF Current Probe: Theory and Application..... 14**

KENNETH WYATT, WYATT TECHNICAL SERVICES

24 TESTING**Testing Products & Services Index..... 24****The Urgent Need to Integrate EMC and Product Safety into Engineering Curriculum of Technical Universities..... 30**

ANTHONY A. DIBIASE, SPEC-HARDENED SYSTEMS

Christmas Music in the Chamber..... 34

CANDACE SURIANO AND JOHN SURIANO

CISPR 32: A New International Standard on Electromagnetic Emissions from Multimedia Equipment..... 40

DANIEL HOOLIHAN, HOOLIHAN EMC CONSULTING

46 AMPLIFIERS / ANTENNAS**Amplifiers / Antennas Products & Services Index..... 46****Antenna to Antenna Coupling on an Aircraft..... 48**

DAVID A. WESTON, EMC CONSULTING, INC.

56 FILTERS / FERRITES**Filters / Ferrites Products & Services Index..... 56**

Photo by Ken Wyatt

14

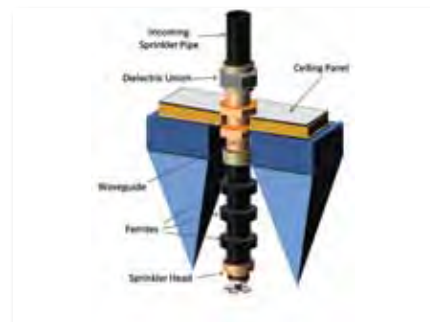

34



52

ON THE COVER Illustration by Evan Schmidt

EM Test Has a New Home



Transient & RF
Conducted
Immunity



Power Quality
Harmonics & Flicker
Measure/Generate



ESD Battery
Powered to 30kV
Modular R-C



Autowave

The World Wide Leader in Conducted EMC has a New Home in North America

Expanding and Enhancing EM Test User Experience in North America:

- **Surpassing** – Standards Specifications and Endurance Expectations
- **Software** – Libraries of Pre-Programmed Test Routines Updated to Latest Standard Editions
- **Service** – EM Test Service Facility Within ISO 9001 Certified Factory in San Diego Supporting North American Customer Base

Contact Us:

If your EM Test equipment needs service or upgrade, you seek superior conducted immunity and measurement equipment, or are just plain curious.



www.emtest.com

EM Test USA, Inc.

9250 Brown Deer Road • San Diego • CA • 92121 • USA • Sales: 202-256-1576 • sales@emtest.com

Shortcomings of Simple EMC Filters 58

ANTONI JAN NALBORCZYK, MPE LTD.

Eliminating the Need for Exclusions Zones in Nuclear Power Stations 68

PHILIP F. KEEBLER, ELECTRIC POWER RESEARCH INSTITUTE

80 CABLES / CONNECTORS

Cables & Connectors Products & Services Index 80

82 SHIELDING

Shielding Products & Services Index 82

Simple Method for Predicting a Cable Shielding Factor, Based on Transfer Impedance 84

MICHEL MARDIGUIAN, EMC CONSULTANT

94 SURGE & TRANSIENTS

Surge & Transients / Conductive Materials Products & Services Index 94

Predicting Security Systems in a Healthcare Facility from Lightning Induced Transients 96

BRYAN COLE, TECHNOLOGY RESEARCH COUNCIL, AND
JIM TIESI, EMERSON NETWORK POWER SURGE PROTECTION

Avionics Testing Evolution 101

NICHOLAS WRIGHT, EMC PARTNER AG

104 DESIGN

Fundamentals of EMC Design: Our Products Are Trying to Help Us 104

KEITH ARMSTRONG, CHERRY CLOUGH CONSULTANTS



60

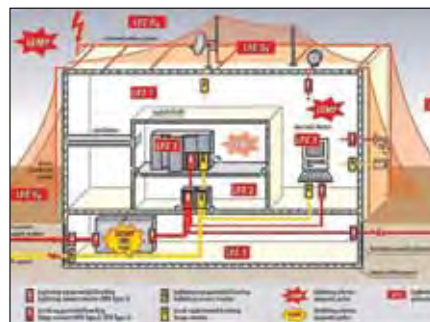

97



103

COMPLETE TEST SYSTEMS FOR EMERGING TECHNOLOGIES



SMART GRID



SOLAR PANELS



ELECTRIC VEHICLES



HV TECHNOLOGIES Inc. is the exclusive sales and service provider in North America

DEPARTMENTS & DIRECTORIES

EDITORIAL.....	8
CONSULTANT SERVICES.....	27
CALENDAR.....	118
STANDARDS RECAP.....	122
PROFESSIONAL SOCIETIES.....	130
GOVERNMENT DIRECTORY.....	136
PRODUCTS & SERVICES INDEX.....	142
COMPANY DIRECTORY.....	151
INDEX OF ADVERTISERS.....	168



118

EDITORIAL REVIEW BOARD

KEITH ARMSTRONG

Cherry Clough Consultants

STEPHEN CAINE

Alion Science & Technology

THOMAS CHESWORTH

Seven Mountains Scientific, Inc.

RICHARD FORD

Consultant

DONALD HEIRMAN

Don Heirman Consultants, LLC

DANIEL D. HOOLIHAN

Hoolihan EMC Consultants

WILLIAM F. JOHNSON

WFJ Consulting

HERBERT MERTEL

Mertel Associates

MARK MONTROSE

Montrose Compliance Services, Inc.

HENRY W. OTT

Henry Ott Consultants

InterferenceTechnology—The EMC Directory & Design Guide, The EMC Symposium Guide, and The EMC Test & Design Guide are distributed annually at no charge to qualified engineers and managers who are engaged in the application, selection, design, test, specification or procurement of electronic components, systems, materials, equipment, facilities or related fabrication services. To be placed on the subscriber list, complete the subscription qualification card or subscribe online at InterferenceTechnology.com.

ITEM Media endeavors to offer accurate information, but assumes no liability for errors or omissions in its technical articles. Furthermore, the opinions contained herein do not necessarily reflect those of the publisher.

ITEM™, InterferenceTechnology™—The EMC Directory & Design Guide™, and Interference Technology.com™ are trademarks of ITEM PUBLICATIONS and may not be used without express permission. **ITEM, InterferenceTechnology—The EMC Directory & Design Guide, The EMC Symposium Guide, The EMC Test & Design Guide** and **InterferenceTechnology.com**, are copyrighted publications of ITEM MEDIA. Contents may not be reproduced in any form without express permission.

What Have You Done For Me Lately? Plenty!



16,000 Watts of Pure Power

Stand back! We've exceeded our old limits with the new 16000A225 amp. It covers 10 kHz to 225 MHz and delivers 16,000 watts of power.

We've Pushed The Technology Envelope

We ripped that envelope wide open with our small, lightweight Solid State Hybrid Power Modules. They deliver high output power (up to 5 watts) across an ultra-wide instantaneous bandwidth (4 to 18 GHz).



Accuracy, Linearity & Bandwidth. Need We Say More?

Our two newest laser-powered E-Field probes, FL7040 – 2 MHz to 40 GHz and FL7060 – 2 MHz to 60 GHz; each do the work of multiple probes, with outstanding accuracy and linearity.



We've Bent The Rules

Our family of Radiant Arrow bent element antennas are up to 75% smaller than standard log periodic antennas. Covering 26 MHz to 6 GHz, these antennas handle the necessary power levels to generate significant E-fields for radiated susceptibility testing.

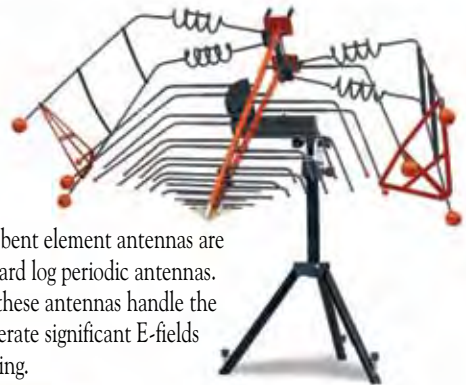

Our New Dual Band Amplifiers Break Down Old Barriers

With two amplifiers in a single package, you can finally go all the way from 0.7 to 18 GHz with the reliability of solid state.



Our New EMI Receiver: Amazing Speed, Incredible Accuracy

The CISPR-compliant DER2018 covers 20 Hz to 18 GHz and beyond. It combines sensitivity, dynamic range and speed with a more intuitive interface.



More Power To You

They're smaller and lighter. Yet our new "S" Series amps are available from 0.8 to 4.2 GHz, 20 to 1200 watts and everything in between.

All-In-One Fully Integrated Test Systems

Get more done in less time with everything right at your fingertips. Since it's all provided by AR, you obtain the best accuracy, lowest risk and greatest support in a fully tested system prior to shipping.



www.arworld.us/plenty

ISO 9001:2008
Certified



rf/microwave instrumentation

Other **ar** divisions: modular rf • receiver systems • ar europe

USA 215-723-8181. For an applications engineer, call 800-933-8181.

In Europe, call ar United Kingdom 441-908-282766 • ar France 33-1-47-91-75-30 • env GmbH 89-614-1710 • ar Benelux 31-172-423-000



www.arworld.us



A NEW LOOK AND FEEL FOR THE EMC BUYERS' GUIDE

EVERY YEAR, INTERFERENCE TECHNOLOGY publishes an EMC Buyers' Guide — our most up-to-date look at the providers of more than 200 EMC-related products and services. This

year, we are introducing changes to both the print and online editions of our directories that will make the process a more interactive and dynamic experience for users, and help streamline the process for busy engineers.

First, you will notice some changes within the pages of this magazine. To help readers pinpoint their areas of interest and delve more deeply into favored topics, we have divided the magazine into six main sections: Test Instrumentation, Testing, Filters & Ferrites, Cables & Connectors, Shielding and Surge & Transients. The sections are marked by colored tabs and within those pages you will find a targeted products and services index and technical articles that address a specific EMC topic.

In the second half of the magazine, you will find reference tools, including a calendar of EMC-related events, information on standards published or updated within the last 12 months, information on professional societies, our Products & Services Index in its entirety, and a listing of companies involved in the EMC field.

With the electronic version of the new *Interference Technology* EMC Buyers' Guide, users will not only be able to find the product and services they seek and the companies that provide them, but, in many instances, they will also find videos, datasheets, white papers and other materials from the companies that provide more comprehensive data on those products and services.

Companies will be able to take ownership of their listings and update information at any time, which means that users are guaranteed to find the most updated information available each time they browse the guide.

These changes should help engineers identify the best solutions for the problem they are trying to solve more quickly and easily than ever before.

Once you have a chance to sample the new print and electronic directories, we'd like to hear what you think so we can adapt accordingly. Please email your comments to me at slong@interferencetechnology.com.

Sarah Long
Editor

SUBSCRIPTIONS

ITEM, *InterferenceTechnology*—The EMC Directory & Design Guide, EMC Symposium Guide, Europe EMC Guide and EMC Test & Design Guide are distributed annually at no charge to engineers and managers engaged in the application, selection, design, test, specification or procurement of electronic components, systems, materials, equipment, facilities or related fabrication services. Subscriptions are available through interferencetechnology.com.

2012 EMC Directory & Design Guide

Publisher
Paul Salotto

Editor
Sarah Long

Graphic Designer
Evan Schmidt

Assistant Editor
Cait O'Driscoll

Marketing
Francesco DiMaio
Jacqueline Gentile

Business Development Manager
Bob Poust

Business Development Executives

Daryl McFadyen
Leslie Ringe
Katie Tolton
Janet Ward

Administrative Manager
Eileen M. Ambler

Circulation Manager
Irene H. Nugent

Product Development Manager
Helen S. Flood

Data Analyst
Karen Holder

President
Graham S. Kilshaw

Publisher Emeritus
Robert D. Goldblum



USA

1000 Germantown Pike, F-2
Plymouth Meeting, PA 19462
Phone: (484) 688-0300
Fax: (484) 688-0303
E-mail:

info@interferencetechnology.com
www.interferencetechnology.com

CHINA, TAIWAN, HONG KONG

Leadzil
Jenny Chen, +86-010-65250537
E-mail: service@leadzil.com

JAPAN

TÜV SÜD Ohtama, Ltd.
Miho Toshima, +81-44-980-2092
E-mail: m-toshima@tuv-ohatama.co.jp

ITEM MEDIA endeavors to offer accurate information, but assumes no liability for errors or omissions. Information published herein is based on the latest information available at the time of publication. Furthermore, the opinions contained herein do not necessarily reflect those of the publisher.

ITEM™, *InterferenceTechnology*™ and *InterferenceTechnology.com*™ are trademarks of ITEM MEDIA and may not be used without express permission. *ITEM*, *InterferenceTechnology* and *InterferenceTechnology.com* are copyrighted publications of ITEM MEDIA. Contents may not be reproduced in any form without express permission.

Copyright © 2012 • ITEM Media • ISSN 0190-0943

E3 Electromagnetic Environmental Effects



EMC
EMI
EMP
EMR
EMV
ESD
EMCON
HEREF
HERO
HERP
HIRF
TEMPEST
COMSEC
LIGHTNING
P-STATIC
RADHAZ
RF WEAPON

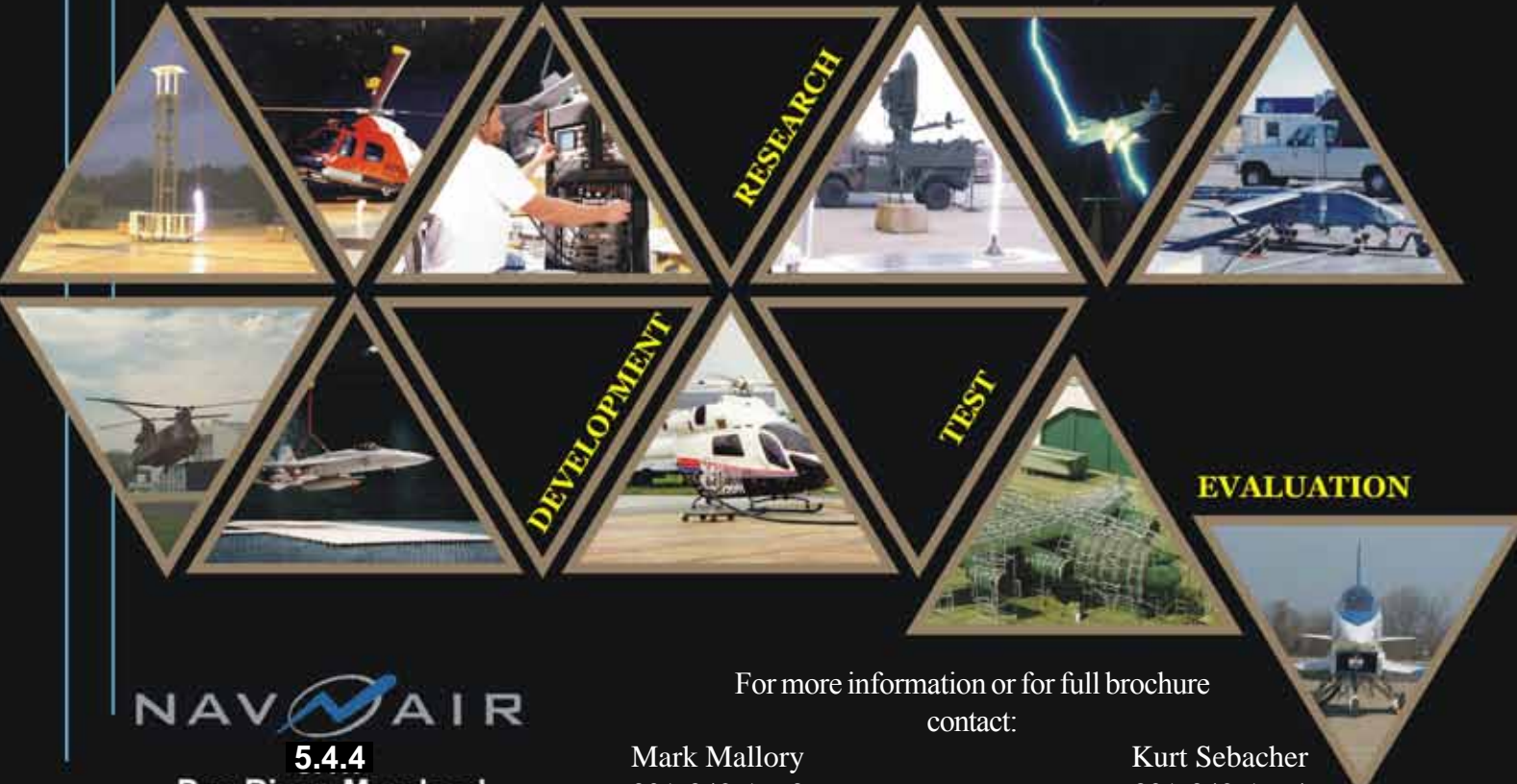

NAV AIR

5.4.4

Pax River, Maryland

For more information or for full brochure contact:

Mark Mallory
301-342-1663

MARK.MALLORY@NAVY.MIL

Kurt Sebacher
301-342-1664

KURT.SEBACHER@NAVY.MIL

TEST INSTRUMENTATION

Products & Services Index

INTERFERENCE TECHNOLOGY'S 2012 Test Instrumentation Products & Services Index contains approximately 50 different categories to help you find the test instrumentation equipment, components, and services you need. Full details of all the suppliers listed within each category can be found in the Company Directory, starting on page 151. The EMC Products & Services Index is presented in its entirety, starting on page 142.

ABSORBER CLAMPS

DNB Engineering, Inc.
ETS-Lindgren
Fischer Custom Communications

BIDIRECTIONAL COUPLERS

Instruments for Industry (IFI)

BROADBAND EMI DETECTORS

Advanced Test Equipment Rentals
Agilent Technologies, Inc.
ETS-Lindgren

COUPLING-DECOUPLING NETWORKS

Haefely EMC

CURRENT PROBES

A.H. Systems, Inc.
ETS-Lindgren
Fischer Custom Communications
Pearson Electronics, Inc.

DESIGN SOFTWARE

AR RF/Microwave Instrumentation
AWR Corporation
CST of America, Inc.
EM Software & Systems
Moss Bay EDA
Sonnet Software, Inc.

ELECTROSTATIC CHARGE / DECAY METERS

Amstat Industries, Inc.
TREK, INC.

ELECTROSTATIC DISCHARGE (ESD) SIMULATORS

Advanced Test Equipment Rentals
CST of America, Inc.
EM Test USA
EMC Partner AG
Fischer Custom Communications
Haefely EMC
HV Technologies, Inc.
Liberty Labs, Inc.
National Technical Systems
Noise Laboratory Co., Ltd.

EMI RECEIVERS

Agilent Technologies, Inc.
AR RF/Microwave Instrumentation
GAUSS Instruments
Inceleris

EMP GENERATORS

EM Test USA
EMC Partner AG

Fischer Custom Communications
HV Technologies, Inc.

EMP SIMULATORS

Advanced Test Equipment Rentals
CST of America, Inc.
EM Test USA
EMC Partner AG
Fischer Custom Communications
HV Technologies, Inc.
Montena Technology sa
National Technical Systems

FCC PART 68 TEST EQUIPMENT

DNB Engineering, Inc.
EM Test USA
EMC Partner AG
HV Technologies, Inc.
Retlif Testing Laboratories

FIBER OPTIC SYSTEMS

Accurate Controls Ltd.
D.A.R.E!! Consultancy
Fischer Custom Communications
Michigan Scientific Corp.
Micronor Inc.

FIELD INTENSITY METERS

EMC Test Design
ETS-Lindgren
Instruments for Industry (IFI)
Narda Safety Test Solutions S.r.l.
Potomac Instruments Inc.
SRICO, Inc.

GROUND RESISTANCE TESTERS

AEMC Instruments, Inc.

GTEM CELLS

ETS-Lindgren
Fischer Custom Communications
Instruments for Industry (IFI)
Noise Laboratory Co., Ltd.

HELMHOLTZ COILS

ETS-Lindgren
Fischer Custom Communications

HIGH VOLTAGE PULSE TRANSFORMERS

Pearson Electronics, Inc.

IMPULSE GENERATORS

AR RF/Microwave Instrumentation
Compliance West, USA
EM Test USA
EMC Partner AG
Haefely EMC

HV Technologies, Inc.
Ion Physics Corp.
National Technical Systems

INDUCED CURRENT METERS & PROBES

AR RF/Microwave Instrumentation
EMC Partner AG
ETS-Lindgren

INSERTION LOSS TEST NETWORKS

Captor Corp.

INTERFERENCE GENERATORS

EMC Partner AG
HV Technologies, Inc.

ISOTROPIC FIELD SENSORS

D.A.R.E!! Consultancy
ETS-Lindgren
Instruments for Industry (IFI)

LIGHTNING GENERATORS

Advanced Test Equipment Rentals
Avalon Test Equipment Corp.
EM Test USA
EMC Partner AG
Fischer Custom Communications
Haefely EMC
HV Technologies, Inc.
Lightning Technologies, Inc.
Noise Laboratory Co., Ltd.

LIGHTNING SIMULATORS

Advanced Test Equipment Rentals
EM Test USA
EMC Partner AG
Fischer Custom Communications
Haefely EMC
HV Technologies, Inc.
Noise Laboratory Co., Ltd.

LISNS

ETS-Lindgren

MAGNETIC FIELD METERS

Combinova AB
Ergonomics, Inc.
Fischer Custom Communications

MAGNETIC FIELD PROBES

Agilent Technologies, Inc.
AR RF/Microwave Instrumentation
ETS-Lindgren
Fischer Custom Communications
Langer EMV-Technik GmbH

NETWORK ANALYZERS

Agilent Technologies, Inc.

PARALLEL PLATE LINE TEST SET

ETS-Lindgren
Fischer Custom Communications

PORTABLE TEST EQUIPMENT

A.H. Systems, Inc.
ETS-Lindgren
Haefely EMC
HV Technologies, Inc.
Instruments for Industry (IFI)
MPB Srl
Prostat Corp.

POWER LINE DISTURBANCE MONITOR

Voltech Instruments Ltd.

RADIATION HAZARD METERS

ETS-Lindgren

RADIATION HAZARD PROBES

ETS-Lindgren
Instruments For Industry (IFI)

RF POWER COMPONENTS

EM Test USA
MKS Instruments

RF POWER METERS

Agilent Technologies, Inc.
AR RF/Microwave Instrumentation
D.A.R.E!! Consultancy
ETS-Lindgren

SIGNAL GENERATORS

Agilent Technologies, Inc.
AR RF/Microwave Instrumentation
D.A.R.E!! Consultancy
Praxsym, Inc.
York EMC Services Ltd.

SIMULATION SOFTWARE

EM Software & Systems
EMS-Plus

SPECTRUM ANALYZERS

Agilent Technologies, Inc.
ValueTronics International, Inc.

TELECOMMUNICATIONS TEST NETWORKS

Agilent Technologies, Inc.
EMC Partner AG
HV Technologies, Inc.

Amplifiers For Every Application!



Solid State Tetrode Tube and Combination Amplifiers

Model Number	Freq Range (MHz)	Min Pwr Out (Watts)	Min Sat Gain (dB)
M/TCCX/SCCX Series • .01-220 MHz			
SCCX300	.01-220	300	55
SCCX500	.01-220	500	57
M404	.01-220	500	57
M406	.01-220	1000	60
TCCX2000	.01-220	2000	63
TCCX2200	.01-220	2200	63
TCCX2500	.01-220	2500	64
CMX/SMX Series • .01-1000 MHz			
SMX301	.01-1000	300/100	55/50
SMX302	.01-1000	300/200	55/53
SMX303	.01-1000	300/300	55/55
SMX501	.01-1000	500/100	57/50
SMX502	.01-1000	500/200	57/53
SMX503	.01-1000	500/300	57/55
CMX10001	.01-1000	1000/100	60/50
CMX100010	.01-1000	1000/1000	60/60



Microwave Solid State and TWT Amplifiers

Model Number	Freq Range (GHz)	Min Pwr Out (Watts)	Min Sat Gain (dB)
T-200 Series • 200-300 Watts CW 1-21.5 GHz			
T251-250	1-2.5	250	54
T82-250	2-8	250	54
T188-250	7.5-18	250	54
T2118-250	18.0-21.7	250	54
T-500 Series • 500 Watts CW 1-18 GHz			
T251-500	1-2.5	500	57
T7525-500	2.5-7.5	500	57
T188-500	7.5-18	500	57
MMT Series • 5-150 Watts, 18-40 GHz			
T2618-40	18-26.5	40	46
T4026-40	26.5-40	40	46
S/T-50 Series • 40-60 Watts CW 1-18 GHz			
S21-50	1-2	50	47
T82-50	2-8	50	47
T188-50	8-18	50	47



Solid State Amplifiers

Model Number	Freq Range (MHz)	Min Pwr Out (Watts)	Min Sat Gain (dB)
SMCC Series • 200-1000 MHz			
SMCC350	200-1000	350	55
SMCC600	200-1000	600	58
SMCC1000	200-1000	1000	60
SMCC2000	200-1000	2000	63
SMC Series • 80-1000 MHz			
SMC250	80-1000	250	54
SMC500	80-1000	500	57
SMC1000	80-1000	1000	60
SMX-CMX Series • .01-1000 MHz			
SMX100	.01-1000	100	50
SMX200	.01-1000	200	53
SMX500	.01-1000	500	57
SVC-SMV Series • 100-1000 MHz			
SVC500	100-500	500	57
SMV500	500-1000	500	57

Visit IFI.com for additional amplifier models and products.

INSTRUMENTS FOR INDUSTRY

903 South Second Street • Ronkonkoma, NY 11779
Tel: 631-467-8400 • Fax: 631-467-8558 • E mail: sales@ifi.com • www.ifi.com

TEM CELLS

ASR Technologies Inc.
ETS-Lindgren
Fischer Custom Communications
Instruments for Industry (IFI)
Noise Laboratory Co., Ltd.

TEMPEST TEST EQUIPMENT

A.H. Systems, Inc.
Fischer Custom Communications

TEST ACCESSORIES

AR RF/Microwave Instrumentation
CST of America, Inc.
EM Test USA
EMC Partner AG
EMCO Elektronik GmbH
ETS-Lindgren
Fischer Custom Communications
Instruments for Industry (IFI)
TDK-Lambda Americas

TEST CAPACITORS

Captor Corp.

**TEST EQUIPMENT,
LEASING & RENTAL**

A.H. Systems, Inc.
Advanced Test Equipment Rentals
AR RF/Microwave Instrumentation

Instruments for Industry (IFI)

**TEST EQUIPMENT,
REPAIR & CALIBRATION**

A.H. Systems, Inc.
Adler Instrumentos SL
Agilent Technologies, Inc.
D.A.R.E!! Consultancy
Electronic Instrument Associates
Embassy Global, LLC
EMC Partner AG
EMSCAN
ETS-Lindgren
Fischer Custom Communications
Instruments for Industry (IFI)
Seibersdorf Labor GmbH

TEST INSTRUMENTATION

A.H. Systems, Inc.
Aaronia AG
Accurate Controls Ltd.
Adler Instrumentos SL
Advanced Test Equipment Rentals
Aeroflex
Agilent Technologies, Inc.
All-Spec Industries
Alltest Instrument, Inc.
Amstat Industries, Inc.
Anritsu Company

Apogee Labs Inc.
APREL Laboratories
AR RF/Microwave Instrumentation
ASR Technologies Inc.
AWR Corporation
Barth Electronics, Inc.
Bird Technologies Group / TX RX
Systems
Circuit Insights LLC
Combinova AB
Compliance West, USA
CST of America, Inc.
D.A.R.E!! Consultancy
D.A.R.E!! Instruments
Ecliptek Corp.
EM Software & Systems
EM Test USA
Embassy Global, LLC
EMC Partner AG
EMSCAN
emscreen GmbH
EMSS Consulting Pty (Ltd.)
emv - Elektronische Meßgeräte
Vertriebs GmbH
Ergonomics, Inc.
ETS-Lindgren
Fischer Custom Communications
Fotofab
GAUSS Instruments
Haefely EMC
HV Technologies, Inc.

Inceleris
Instruments for Industry
(IFI)
Langer EMV-Technik GmbH
Laplace Instruments Ltd.
Liberty Labs, Inc.
Macton
Michigan Scientific Corp.
Micronor Inc.
Mihajlo Pupin Institute-
EMC Lab
Montena Technology sa
MPB Srl
Narda Safety Test
Solutions S.r.l.
NEDC Fabricating Solutions
Noise Laboratory Co., Ltd.
Pearson Electronics, Inc.
Potomac Instruments Inc.
PPM (Pulse Power &
Measurement) Ltd.
Praxsym, Inc.
Protek Test and
Measurement
Ramsey Electronics

Rohde & Schwarz USA, Inc.
Saelig Company
Safe Engineering Services &
Technologies, Ltd.
Safety Test Technology Co., Ltd
Seibersdorf Labor GmbH
Sensor Products Inc.
Shanghai Empek
Electromagnetic Technology
Ltd.
SILENT Solutions
SimLab Software GmbH
Solar Electronics Co.
Suzhou 3CTEST Electronic Co.,
Ltd.
TE Connection Asia
TESEO
Teseq
Thermo Fisher Scientific
TREK, INC.
ValueTronics International, Inc.
Wavecontrol

TEST SOFTWARE

Averna
D.A.R.E!! Consultancy
NEXIO
CST of America, Inc.

**TRANSIENT DETECTION &
MEASURING EQUIPMENT**

Advanced Test Equipment Rentals
Circuit Insights LLC
Pearson Electronics, Inc.
Rohde & Schwarz USA, Inc.

TRANSIENT GENERATORS

Advanced Test Equipment Rentals
EM Test USA
EMC Partner AG
Fischer Custom Communications
Haefely EMC
HV Technologies, Inc.
Noise Laboratory Co., Ltd.
Teseq
Transient Specialists, Inc.

TURNTABLES

ETS-Lindgren
Macton

VOLTAGE PROBES

Fischer Custom Communications
Haefely EMC

YOUR ONLINE RESOURCE FOR EMI / EMC

- Interactive EMC Buyers' Guide
- News, Standards, & Product Updates
- 17 technology & market channels
- And more

Search archives by topic
Share with social media
Comment on news stories

Visit us now!
interferencetechnology.com

interference
THE INTERNATIONAL JOURNAL OF
ELECTROMAGNETIC COMPATIBILITY | **technology**

ITEM
MEDIA



Update, add or edit your company's information in
Interference Technology's new interactive, electronic
EMC Buyers' Guide available at
www.interferencetechnology.com



There's a Reason Why Engineers Choose ETS-Lindgren:

More Experts, Experience and Expertise *than anyone else!*

ETS-Lindgren has a long history of providing EMC engineers with the tools they need to make accurate, repeatable measurements. Little wonder we are now the largest integrated manufacturer of EMC test equipment in the world;

we serve our customers with engineering, manufacturing and support facilities in North America, South America, Europe and Asia. Visit our website at www.ets-lindgren.com or call us to see how our experts can help you.

Enabling Your Success™

 **ETS·LINDGREN™**

An ESCO Technologies Company

www.ets-lindgren.com

Phone +1.512.531.6400 • info@ets-lindgren.com

Offices in the US, Brazil, Finland, Germany, UK, France, India, Japan, Singapore, China, Taiwan

©2012 ETS-Lindgren

The HF Current Probe: Theory and Application

KENNETH WYATT

Wyatt Technical Services
Woodland Park, Colorado, USA

This article describes one of the most valuable tools in the EMC engineers “bag of tricks” – the high-frequency current probe. Current probes are invaluable for measuring high-frequency common-mode (or “antenna”) currents flowing on wires or cables. Experience has proven that poorly terminated (bonded or filtered) cables are the number-one cause for radiated emissions failures at a test facility. By measuring the common-mode (CM) currents (sometimes referred to as “antenna” currents) on these cables it’s possible to troubleshoot and apply fixes to a product right there in your development lab. You can also predict, to a good degree of accuracy, whether a given cable current will pass or fail in the measurement chamber. This will save you tons of time trying to apply fixes at the test facility while the clock is ticking away your test time. I’ll also show you several ways to create do-it-yourself (DIY) probes that are quick to make and very useful in a pinch.

COMMON-MODE CURRENTS

Let’s consider CM currents and how they are generated, because it is not intuitive as to how current may travel the same direction through both the signal and signal-return wires in a cable or PC board. Referring to Figure 1, note that due to finite

impedance in any grounding system (including circuit board signal/power return planes), there will be a voltage difference between any two points within that return plane. This is denoted by V_{GND1} and V_{GND2} in the figure. This difference in potential will drive CM currents through common cabling or circuit traces between circuits or sub-systems. In addition, unbalanced geometries - for example, different lengths or path routings for high-speed differential pairs - can create voltage sources that drive associated CM currents. Finally, routing a high-speed clock trace across a split in the return plane or referencing it to multiple planes, can also be a source of CM current. Because the current phasors in Figure 1 are additive, the resulting radiated phasor may be quite large compared to those generated by differential-mode (DM), or signal currents, which are opposite in direction, and so tend to cancel. Therefore, CM emissions tend to be more of an issue than DM emissions.

CURRENT PROBES: THEORY OF OPERATION

The RF current probe is an “inserted-primary” type of radio frequency current transformer. When the probe is clamped over the conductor or cable in which current is to be measured, the conductor forms the primary winding. The clamp-on feature of this probe enables easy placement around any conductor or cable. This is essentially a broadband high-frequency transformer. High-frequency currents can

**Verifying EMC performance is one thing.
Diagnosing the cause of EMI is quite another.**



When you find a device out of EMI compliance, now you can also understand why. Because the new Agilent receiver is also an X-Series signal analyzer, loaded with diagnostics to show what's happening. **That's thinking ahead. That's Agilent.**

Agilent N9038A MXE EMI Receiver

CISPR 16-1-1 2010 compliant

Built-in X-Series analyzer runs applications

Intuitive interface and graphical displays

Upgradable for long-term flexibility

Download Competitive Comparison and App Note:
Reduce Verification Time with Fast Scanning.
www.agilent.com/find/AgilentEMIreceiver



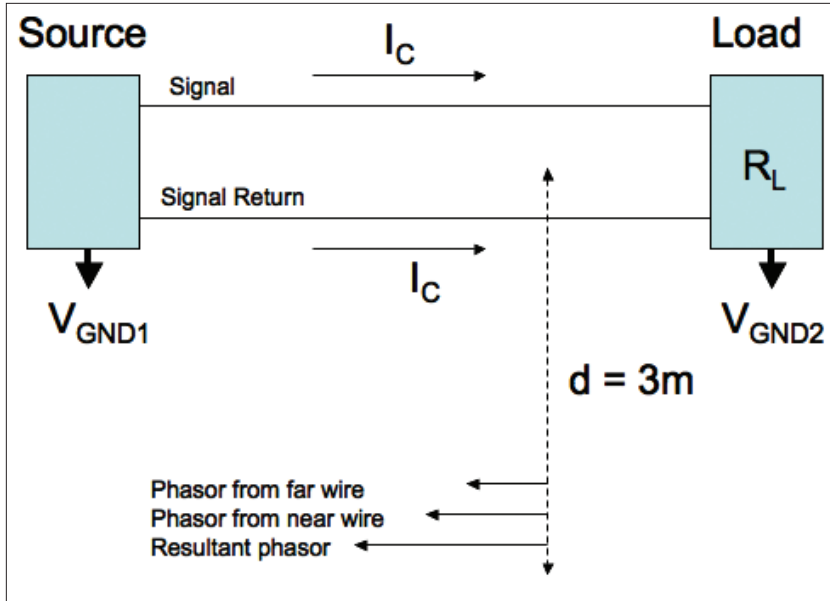

Figure 1. Common-mode currents in a circuit loop. The source is a digital signal (with harmonics) and we'll assume a resistive load. Because the phasor current in the far wire is in the same direction as the phasor current in the near wire, the resultant phasor is relatively large compared to that produced by differential-mode current phasors. In this case, lowering the harmonic content (by slowing the digital rise/fall-times) or diverting/blocking the CM current is very important in limiting radiated emissions.

be measured in cables without physically disturbing the circuit.

Since the current probe is intended for “clamp-on” operation, the primary shown in Figure 2 is actually the electrical conductor in which CM currents are to be measured. This primary is considered as one turn since it is assumed that the CM currents flow through the conductor and return to the source via a return conductor such as a frame, common ground plane, or earth. On some current probe models the secondary output terminals are resistively loaded internally to provide substantially constant transfer impedance over a wider frequency range.

COMMERCIAL CURRENT PROBES

While commercial current probes are pricey, the advantage is that they can open up and snap around a cable, rather than having to be threaded onto the cable to be measured. See Figure 3. They are also a lot more rugged and can take a lot of abuse as compared to the “do-it-yourself” (DIY) versions below. Finally, they are also accurately characterized, allowing very precise measurements of cable currents.

DIY CURRENT PROBES

In a pinch, you can make your own current probe. Examples of several DIY probes are shown in Figures 4 and 5. I typically try to find a ferrite

toroid or clamp-on core that offers good high-frequency characteristics in the 10 to 1000 MHz range. Winding a few (not too critical) turns and terminating with a coax connector is all you need. Keeping the turns as far apart as possible (as in Figure 4) will reduce inter-winding capacitance and yield better results at the higher frequencies. This is one of the largest drawbacks in performance of the clamp-on ferrites (as in Figure 5).

TRANSFER IMPEDANCE

The CM current (I_c) in microamps in the conductor under test is determined from the reading of the current probe output (V) in microvolts divided by the current probe transfer impedance (Z_T).

$$I_c = V/Z_T \tag{1}$$

Or, in dB

$$I_c(\text{dBuA}) = V(\text{dBuV}) - Z_T(\text{dB}\Omega) \tag{2}$$

The typical transfer impedance of the current probe throughout the frequency range is determined by passing a known RF current (I_c) through the primary test

conductor and noting the voltage (V) developed across a 50-Ohm load. Then,

$$Z_T = V/I_c \text{ (in standard units)} \tag{3}$$

Or

$$Z_T(\text{dB}\Omega) = V(\text{dBuV}) - I_c(\text{dBuA}) \tag{4}$$

The Fischer F-33-1 probe is a commonly used troubleshooting tool and has a flat frequency response from 2 to 250 MHz (Figure 6). The transfer impedance is about 5Ω (approximately +14 dBΩ on the graph), therefore, a 1 uA current will produce a 5 uV output voltage from the current probe.

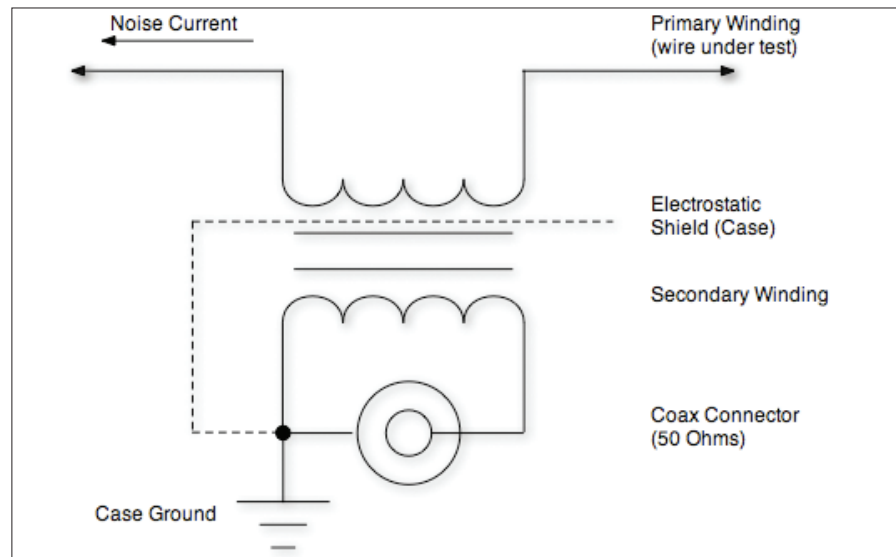

Figure 2. The basic current probe (high-frequency current transformer).

WHO SAYS YOU CAN'T HAVE IT ALL?

and with next-day, on-time delivery

DRG Horns
170 MHz - 40 GHz
6 Models

Log Periodics
80 MHz - 7 GHz
13 Models

Preamplifiers
20 MHz - 40 GHz
8 Models

Low Loss Cables
DC - 40 GHz
4 Models

H-Field Rods
100 Hz - 30 MHz
4 Models

Probes
20 Hz - 1 GHz
16 Models

Loops
20 Hz - 30 MHz
7 Models

Monopoles
100 Hz - 60 MHz
5 Models

Tripods and Accessories

Standard Gain Horns
1 GHz - 40 GHz
9 Models

BiLogicals
25 MHz - 7 GHz
8 Models

Biconicals
20 MHz - 330 MHz
5 Models

All in one small package

You Can Have It All when it comes to EMC/EMI testing. A.H. Systems is proud to bring you exciting new products, and many reliable favorites for your evaluation and compliance applications. Our antennas are unique and distinctive with broadband frequency ranges between 20 Hz up to 40 GHz. This enables us to specialize in various sales, rentals and, re-calibrations of test Antennas throughout the world. To view our products and get quick answers to your questions, access our comprehensive online catalog. Search for various information about product descriptions, typical AF plots, VSWR, power handling capabilities and links to product data sheets. Or simply request a catalog be sent to you. Not only have we been developing EMI Antennas for over 30 years, we also have organized worldwide sales representation. You can find your local knowledgeable representative in over 27 countries via our website. For quality products, excellent service and support with next-day, on-time delivery.

Antennas...

And Kits too.



Innovation Quality Performance
Phone: (818)998-0223 • Fax (818)998-6892
www.AHSystems.com?IT

A.H. Systems

PROBE CALIBRATION

The accurate calibration of RF current probes is a complex process. Characterization is a more correct term to use than calibration. The probe must be properly characterized to reflect how the user uses the probe. Probe manufacturers usually sell a calibration fixture that attempts to maintain a 50Ω impedance. A 50Ω load is connected to the output port and a calibrated RF generator (or network analyzer) is connected to the input port. The probe to be characterized is clamped around

the fixture and the frequency is swept while measuring the probe output.

My test setup was a little more rudimentary (Figure 7), but for troubleshooting purposes, it's good enough. I used a short piece of stiff wire across the output port with a 50Ω resistive load in series. I then adjusted the generator for zero dBm – a convenient amount. This is equivalent to an output voltage of 224 mV (or 73 dBuA of current) into 50Ω. The actual generator output doesn't matter, so long as the resulting probe voltage is large enough to be seen readily in the receiver or spectrum analyzer. I monitored the probe output with a Thurlby Thander TTI PSA2701T handheld spectrum analyzer.

Knowing the current through the wire in dBuA and the probe output in dBuV, the transfer impedance may be plotted graphically by subtracting: $V(\text{dBuV}) - I(\text{dBuA})$ (expressed in dB). In this case, $Z_T(\text{dB}\Omega) = V(\text{dBuV}) - 73$. While this may be useful for educational purposes, I wouldn't be too inclined to use the DIY probes to predict "pass/fail", as described further down. However, because they compare favorably to the commercial probes as far as output voltage, I believe (and have proven in practice) that they are completely suited for troubleshooting. You only need to know whether an EMC design fix made the cable current better or worse.

PREDICTING PASS/FAIL

It is possible to predict whether a particular cable will pass or fail radiated emissions by measuring the CM current at the offending frequency, reading off the transfer impedance of the probe, Z_t (dBΩ) in Figure 6, and solving for I_c (using Equation 2 above). Plugging I_c (Amps) into Equation 5 will calculate the E-field level in V/m. The length of the cable is L (m) and the offending harmonic frequency is f (Hz). Use a test distance, d , of either 3 or 10m to predict the outcome at those test distances.

$$|\hat{E}_{c,\text{max}}| = 1.257 \times 10^{-6} \frac{I_c |fL|}{d} \quad (5)$$

Once you've determined a particular cable has CM currents that may cause a RE failure, you should to examine the connector where the cable is attached to the product

Electronics Test Centre

The Electronics Test Centre brings compliance, certification services, customized test and engineering to the Automotive, Medical, Military, and Commercial industries.

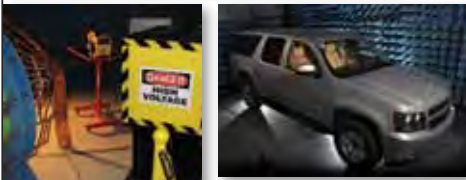

ETC Service Highlights

- EMI/EMC Testing & Consultation
- HIRF [greater than 200 V/m]
- Lightning [up to Level 5 & Beyond]
 - Pin, SS, MS, MB
- Surge and Customized Transients
- T-PEDS
- RF Site Surveys
- Shielding Effectiveness
- Transmissivity Testing
- Safety
- Training Courses

Lab Highlights

- NARTE Certified Technicians, E3 Technologists & Electrical/Mechanical Engineers
- 5 Anechoic Chambers
- HIRF Test Facilities
- High Voltage Lab
- Mechanical Engineering & Design
 - Engineering and analysis of materials and components
- Custom Fabrication
- Machining, MIG, TIG Welding

Compliance Testing

- Aeronautical
 - DO-160, Airbus, Boeing
- Automotive
 - SAE, CISPR, ISO E-Mark
- Commercial
 - CISPR, CE Mark, ANSI
- Military
 - MIL-STD, DEF-STAN
- Medical
 - CISPR
- Nuclear
 - NUREG
- Rail
 - EN for EMC & Surges
- Space
 - IEEE
- Telecom
 - Telcordia, FCC, IC
- Wireless
 - FCC, Industry Canada, European, ETSI



ELECTRONICS TEST CENTRE

302 Legget Drive, Unit 100 | Kanata | Ontario
613-599-6800 | etc-mpb.com | inquiries@etc-mpb.com



Figure 3. Examples of commercial current probes.



Figure 4. Examples of DIY current probes based on a large toroid core. These photos were taken prior to installing the E-field shield which consists of a layer of copper tape over the windings, leaving a small gap around the inside of the toroid. 14 turns of Teflon-insulated wire wound around a Würth Elektronik #74270097 ferrite core (4W620 material) was used, which is useful from 10 to 1000 MHz.



Figure 5. Examples of DIY current probes based on clamp-on ferrite chokes. I used a couple sample Steward (now a unit of Laird Technologies) chokes – a round one (model 28A3851-0A2) and a square one (model 28A2024-0A2). They each had 7 turns of Teflon-insulated wire wound around one-half and glued down on the inside to hold the windings. I later epoxied a PC board-style BNC connector to the outside, making sure there was enough epoxy to hold the outer turns together. Type 28 material was used, which is useful from 10 to 1000 MHz.

enclosure. Very often, I find poor or non-existent bonding between the connector shield and enclosure shield. These points must be bonded well to permit the CM currents to flow back to their source within the product, avoiding associated cable radiation. Please refer to my previous articles on troubleshooting radiated emissions for more information (references below).

REAL-WORLD TROUBLESHOOTING EXAMPLE

As previously mentioned, one of the most common sources of radiated emissions is due to poorly bonded connectors mounted on shielded product enclosures. This occurs especially if the connectors are circuit board mounted and penetrate loosely through the shielded enclosure. Poorly bonded connectors allow internally generated CM currents to leak out and flow on the outside of I/O, mouse or keyboard cables. This will also allow ESD discharges inside the product – more bad news. If these currents are allowed out of the enclosure, the attached cables will act as radiating antennas – often resonating around 300 MHz, due to their typical 1m length.

This was the case for a new digitizing oscilloscope prototype I worked on recently. The I/O connectors were all soldered onto the PC board and the board was fastened to the rear half of the enclosure. The connectors simply poked up through cutouts in the rear metal shield.

While using a current probe to measure the CM current flowing on the outside of the USB cable under test, I simply jammed the screwdriver blade of my Swiss Army knife between the connector bonding fingers and metal chassis enclosure and was able to drop the overall cable currents by 10 to 15 dB.

The solution was to fabricate a custom shim with spring-fingers that would slip over all the connectors creating a firm bond between the connector ground shell and inside of the shielded enclosure. More and more low-cost products are relying on PC board mounted I/O connec-

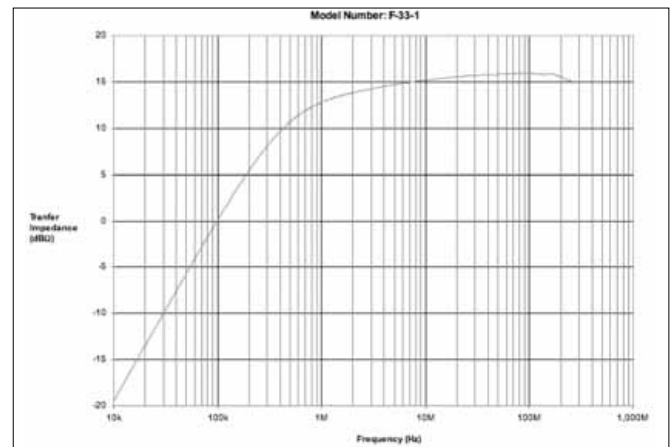

Figure 6. Transfer impedance (ZT) graph of an F-33-1 current probe (courtesy of Fischer Custom Communications). The x-axis is frequency, while the y-axis is dBΩ. Use this to calculate the value of I_c (Equation 2), given the measured voltage at the probe terminals (V_{dBuV}) and Z_T.

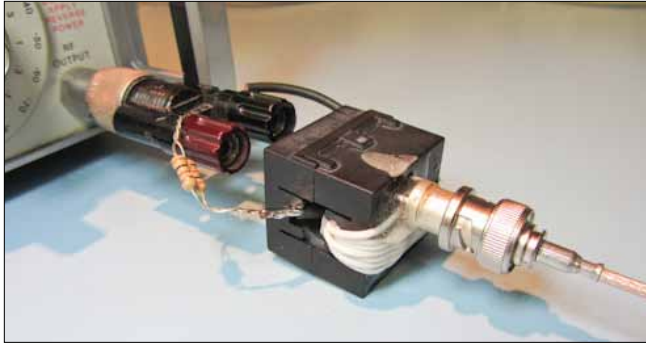

Figure 7. I used a short wire and 50Ω load (two parallel 100Ω resistors) across the generator output for probe characterization. Obviously, there are shortcomings at higher frequencies, due to the inductance of the wire. In fact, the system impedance starts to go capacitive at 100 MHz and it's difficult to keep a fixed 224 mV across the load resistor with frequency.

tors as a cost-cutting measure. Any time you see this, be prepared to carefully examine the bonding between the connector ground shell and the shielded enclosure.

TROUBLESHOOTING TIPS USING CURRENT PROBES

Here are a few troubleshooting tips using current probes.

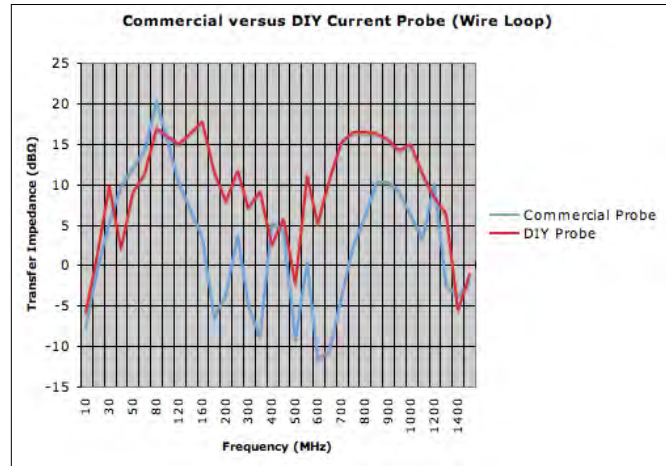

Figure 8 Transfer impedance (Z_T) graph of a commercial current probe versus the DIY toroidal probe. The x-axis is frequency, while the y-axis is dBΩ. Note that the commercial probe is only designed and characterized to 250 MHz, so the data above that, while interesting, is probably not valid. The DIY probe, as well, performs poorly above 200 MHz and frankly, the wire loop used to introduce a “calibrated” current (while as short as possible) affects the measurement, as well.

1. When evaluating the harmonics on a cable by using a current probe, if sliding the probe back and forth changes the harmonic levels, part of the coupling may be near-field, rather than conducted.

2. When using a pair of current probes; one on each of two cables, if the harmonics are the same in each, the source is in the middle. If one cable has stronger harmonics, then you'll want to work on that side first. See Figure 12 below.

3. Measuring the currents on two suspect legs of a dipole should read the same. Placing the two suspect legs through the same current probe should cause a big decrease due to current cancellation. See Figure 12 below.

4. When measuring video cable currents and large cable movements cause big changes in amplitude, the coupling is likely inductive - otherwise, it's more likely conductive.

5. If you suspect inductive coupling, the phase at the victim will be 180-degrees from the source. This may be observed on an oscilloscope with H-field probes or current probes. Try syncing the scope trigger at the source using a scope probe.

My colleague, Doug Smith, has many more examples on how to use current probes for measuring cable and PC board resonances, injecting pulses for troubleshooting, interpreting the relative phase of common-mode currents and troubleshooting ESD issues. Refer to the references below.

SUMMARY

Use of a current probe is vital during the troubleshooting process. Poorly bonded cable connectors can be readily identified and fixed. The radiated E-field from a product I/O cable may be calculated by measuring the high-frequency common-mode currents flowing in the cable. All this may be performed right at the designer's

workbench and without the expense of a third-party test facility or shielded chamber.

REFERENCES - PAPERS

- [1] Mat Aschenberg & Charles Grasso, Radiation from Common-Mode Currents – Beyond 1 GHz (Three Methods Compared)
- [2] Dave Eckhardt, Homebrew Clamp-On Current Probe, private correspondence (January 2009), Email: davearea51@wild-blue.net.
- [3] Jasper Goodblood, Electromagnetic Compatibility, 1990, Prentice Hall, pages 31-34.
- [4] Michel Mardiguian, EMI Troubleshooting Techniques, McGraw-Hill, 2000, pages 39-49.
- [5] Montrose & Nakauchi, Testing for EMC Compliance, 2004, Wiley Interscience, pages 116-124, 143-145, and 159-161.
- [6] Henry Ott, Electromagnetic Compatibility Engineering, Wiley, 2009, pages 690-693.
- [7] Henry Ott, Measuring Common-Mode Currents on Cables, www.hottcon-

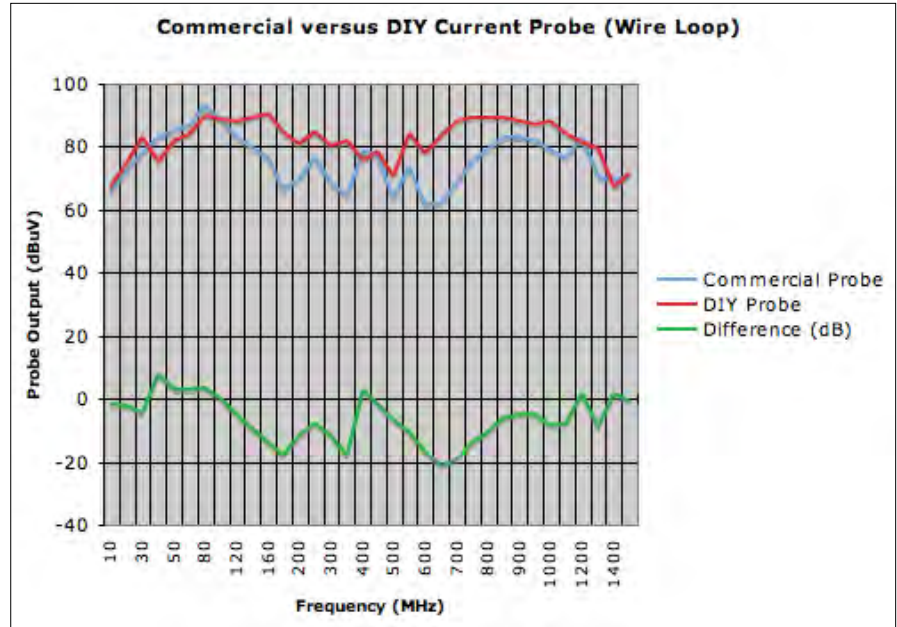

Figure 9. Probe output voltage (V_{out}) graph of a commercial current probe versus the DIY toroidal probe. The x-axis is frequency, while the y-axis is dBuV. This shows that the probes are very comparable in output voltage versus frequency. For troubleshooting purposes, absolute accuracy is not required - just consistency in measurements. All one really needs to know is, "did the fix I implemented make the CM current go up or down?" The DIY probe works well for this.



MULTIFUNCTION GENERATOR NSG 3040 –

BIG THINGS COME IN SMALL PACKAGES

It is small, smart and has a high-contrast 7" touchscreen color display and the rotary wheel for quick input with appealing ease of operation. With its open modular architecture, the NSG 3040 is the ideal immunity test companion for smaller engineering labs – with amazing capacities for demanding EMC testing companies and for easy integration into the production process. The electromagnetic pulses generated from this multipurpose unit are especially tailored for CE marking requirements of the EU in addition to the national and international standards. Like its big brother, NSG 3060 (6.6 kV), the NSG 3040 also has a SD memory card where test files can be saved easily and expanded at any time.

- Modular, expandable system
- Surge voltage to 4.4 kV
- EFT/Burst to 4.8 kV/1 MHz
- PQT to 16A/260 VAC & DC
- Easy-to-operate 7" touchscreen color display
- TA (Test Assistance) for rapid test resolution
- Parameters can be changed during test

Teseq Inc. New Jersey 08837 USA
T: +1 732 417 0501 www.tesequsa.com



Advanced Test Solutions for EMC

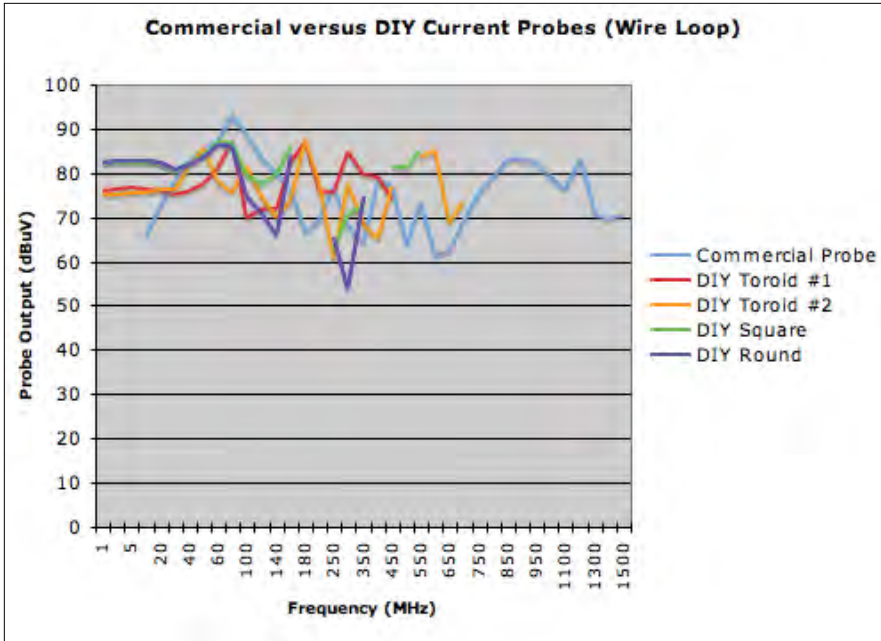



Figure 10. Probe output voltage (V_{out}) graph of a commercial current probe versus two DIY toroidal probes and two different clamp-on probes. The x-axis is frequency, while the y-axis is dBuV. This shows that all these probes are very comparable in output voltage versus frequency and therefore, useful for troubleshooting purposes. Just don't try using the DIY probes to determine "pass or fail" predictions. Commercial probes are better-suited for that.

- sultants.com/techtips/tips-cm.html
- [8] Clayton Paul, Introduction to Electromagnetic Compatibility (2nd Edition), Wiley Interscience, 2006, pages 518-532.
- [9] Ridao, Carrasco, Galvin and Franquelo, Implementation of low cost current probes for conducted EMI interference measure in Power Systems, EPE 1999 (Lausanne).
- [10] H. Ward Silver, Hands-On Radio column, Detecting RF – Part 2, QST, August

- 2011, page 54-55.
- [11] Doug Smith, Current Probes, More Useful Than You Think, IEEE EMC Symposium 1998, <http://emcesd.com/pdf/iprobe98.pdf>.
- [12] Doug Smith, The Two Current Probe Puzzle, <http://emcesd.com/tt061999.htm>.
- [13] Doug Smith, Using Current Probes to Inject Pulses for Troubleshooting, <http://emcesd.com/tt2007/tt120307.htm> Part 1,

- <http://emcesd.com/tt2009/tt030309.htm> Part 2.
- [14] Doug Smith, Using Current Probes to Measure Cable Resonance, <http://emcesd.com/tt2008/tt010108.htm>.
- [15] Doug Smith, Measuring and Interpreting the Relative Phase of Common Mode Currents, <http://emcesd.com/tt2008/tt030208.htm>.
- [16] Doug Smith, Using a Comb Generator with a Pair of Current Probes to Measure Cable Resonance, <http://emcesd.com/tt2009/tt110709.htm>.
- [17] Doug Smith, Using Current Probes to Inject Pulses for Troubleshooting (Board Resonances), <http://emcesd.com/tt2010/tt010110.htm>.
- [18] Doug Smith, Predicting Cable Emissions from Common Mode Current, <http://emcesd.com/tt2006/tt030106.htm>.
- [19] Douglas Smith, High Frequency Measurements and Noise in Electronic Circuits, Van Nostrand Reinhold, 1993, pages 41-44, 159-182, 192-209.
- [20] Allen Wolff, Building a Ferrite Core Antenna Current Probe, Technical Correspondence, QST, August 2009, page 53.
- [21] Kenneth Wyatt, Troubleshooting Radiated Emissions Using Low-Cost Bench-Top Methods, Interference Technology (ITEM) – EMC Directory & Design Guide 2011, May 2011, page 10-21, http://www.interferencetechnology.com/uploads/media/Wyatt_DDG11.pdf.
- [22] Kenneth Wyatt, Troubleshooting Radiated Emissions – Three Case Studies, InCompliance Magazine, October 2011, http://www.incompliancemag.com/index.php?option=com_content&view=article&id=818:troubleshooting-radiated-emissions-three-case-studies&catid=27:testing&Itemid=136.



Looking from 500 to 1000 MHz

Start: 500.000MHz Stop: 1000.000MHz



Before

Start: 500.000MHz Stop: 1000.000MHz

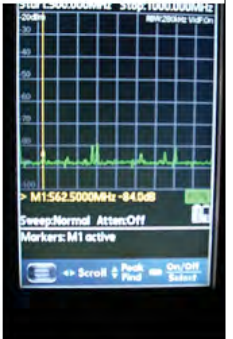

After

Some harmonics dropped by 10-15 dB!

Test setup:
Current probe on USB cable.
Connection between connector ground shell and chassis enclosure made with screwdriver blade.

Figure 11. Cables should be tested individually. Here, I have a current probe clamped around the cable under test and am monitoring the harmonics with a simple hand-held spectrum analyzer. As I ground the connector shell to the chassis with the Swiss Army screwdriver blade, the harmonics were reduced 10-15 dB!

REFERENCES - SUPPLIERS

- [23] Fischer Custom Communications (FCC), Phone: (310) 303-3300, Email: sales@fischercc.com, Web: www.fischercc.com. They provide a very wide range of HF current probes – their specialty.
- [24] Laird Technologies, Web: <http://www.lairdtech.com/Products/EMI-Solutions/>. They offer a complete line of ferrite cores and chokes.
- [25] Pearson Electronics, Phone: (650) 494-6444, Email: sales@pearsonelectronics.com, Web: www.pearsonelectronics.com. They have a good selection of probes.

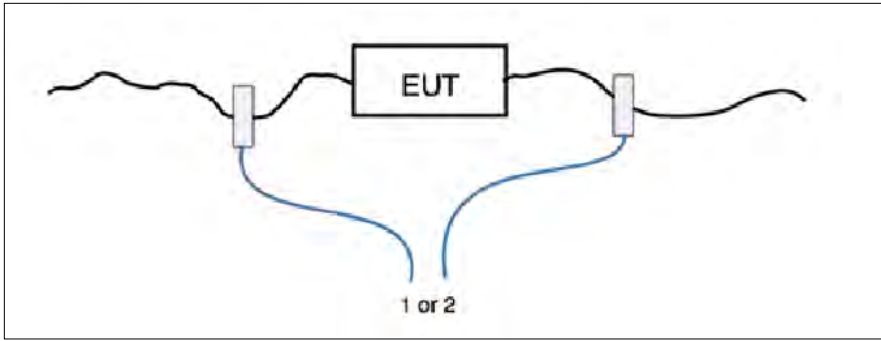

Figure 12. When measuring two cables from a system and the harmonic currents are approximately the same (point 1 is the same as point 2), the source is at the center (the EUT) and the two cables are acting as a dipole antenna. You may notice a peak in harmonic strength at the half-length of the two cables combined. If the harmonic currents are larger in one side or the other, then you'll want to troubleshoot just that cable.

KENNETH WYATT, Sr. EMC Engineer, Wyatt Technical Services LLC, holds degrees in biology and electronic engineering and has worked as a senior EMC engineer for Hewlett-Packard and Agilent Technologies for 21 years. He also worked as a product development engineer for 10 years at various aerospace firms on projects ranging from DC-DC power converters to RF and microwave systems for shipboard and space systems. A prolific author and presenter, he has written or presented topics including RF amplifier design, RF network analysis software, EMC design of products and EMC troubleshooting techniques. He has been published in magazines such as, *RF Design*, *EMC Design & Test*, *Electronic Design*, *InCompliance*, *Interference Technology*, *Micro-wave Journal*, *HP Journal* and several others.

Wyatt is a senior member of the IEEE and a long time member of the EMC Society where he serves as their official photographer. He is also a member of the dB Society and is a licensed amateur radio operator. Contact Wyatt at ken@emc-seminars.com. His website is www.emc-seminars.com.

- [26] Rhode & Schwartz USA, Phone: (888) 837-8772, Email: info@rohde-schwarz.com, Web: www.rohde-schwarz.us. They have a very limited selection.
- [27] Solar Electronics, Phone: (800) 952-5302, Email: sales@solar-emc.com, Web: www.solar-emc.com. They have a limited selection.
- [28] Teseq USA, Phone: (732) 417-0501, Email: usasales@teseq.com, Web: www.teseq.us. They have a very limited selection.
- [29] Thurlby Thunder Instruments, Phone: +44-1480-412451, Email: sales@tti-test.com, Web: <http://www.tti-test.com/contact-tti.htm>. They offer a low-cost handheld spectrum analyzer for under \$2,000 USD.
- [30] Würth Electronics Midcom, (605) 886-4385, midcom@we-online.com, www.we-online.com. I used one of their large ferrite cores for my DIY current probe.

NoiseKen Superior EMI Simulators for Quality Products



NEW

Electrostatic Discharge Simulator
ESS-S3011/B3011/L1611
 Conforms to IEC61000-4-2 and ISO10605
 30kV output
 Automatic voltage ramping and Program mode



Component Level Electrostatic Discharge Simulator
ESS-6002/6008
 Component HBM and MM testing
 Flexible DUT interface
 0.4 mm minimum lead pitch



Impulse Noise Simulator
INS-4020/4040/AX2 Series
 1 ns rise time square pulse
 Variable pulse width
 Line to line and line to ground coupling modes



NEW

Lightning Surge Simulator-Compact type
LSS-6230
 Conforms to IEC-61000-4-5 (1.2/50; 8/20µs)
 ANSI/IEEE C62.45 Ring Wave (0.5µs-100kHz)
 Max. voltage 6.6kV



NEW

Emission Measurement System for PCB
EPS-6000
 Measures PCB Near field emission
 in X,Y,Z,θ directions
 3D Photo/distribution map data image

USA Sales & Support
Shinyei Corp. of America
 New York, NY 10018 USA
 TEL 917-484-7893
 Fax 212-704-4206
 E-mail: noiseken@sca-shinyei.com
Noise Laboratory Co., Ltd.
 Kanagawa, Japan
 Tel: +81-42-712-2051
 Fax: +81-42-712-2050
 E-mail: sales@noiseken.com

For more information
www.noiseken.com

TESTING

Products & Services Index

INTERFERENCE TECHNOLOGY'S 2012 Testing Products & Services Index contains approximately 35 different categories to help you find the testing equipment, components, and services you need. Full details of all the suppliers listed within each category can be found in the Company Directory, starting on page 151. The EMC Products & Services Index is presented in its entirety, starting on page 142.

ANECHOIC CHAMBER TESTING

D.A.R.E!! Instruments
DNB Engineering, Inc.
Electronics Test Centre (Kanata)
ETS-Lindgren
National Technical Systems
Radiometrics Midwest Corp.
Retlif Testing Laboratories
TUV SUD America Inc.

AUTOMOTIVE TESTING

D.A.R.E!! Instruments
D.L.S. Electronic Systems, Inc.
Elite Electronic Engineering Co.
National Technical Systems
Radiometrics Midwest Corp.
Teseq

BELLCORE TESTING (SEE TELCORDIA)

D.L.S. Electronic Systems, Inc.
National Technical Systems
TUV SUD America Inc.

CALIBRATION SERVICES

A.H. Systems, Inc.
Austest Laboratories
D.A.R.E!! Calibrations
ETS-Lindgren
Fischer Custom Communications
Instruments for Industry (IFI)
LTI Metrology
National Technical Systems
Pearson Electronics, Inc.
Teseq
TUV SUD America Inc.

CALIBRATION TESTING

D.A.R.E!! Calibrations
Liberty Labs, Inc.

CERTIFICATION SERVICES

Braco Compliance Ltd.
D.L.S. Electronic Systems, Inc.
DNB Engineering, Inc.
Electronics Test Centre (Kanata)
Elite Electronic Engineering Co.
ITEM Media
MET Laboratories, Inc.
National Technical Systems
Radiometrics Midwest Corp.
TUV SUD America Inc.

COMPETENT/CERTIFIED ACCREDITING BODIES TESTING

D.A.R.E!! Instruments
D.L.S. Electronic Systems, Inc.
Elite Electronic Engineering Co.
National Technical Systems

COMPUTER-AIDED ANALYSIS SERVICES

Apache Design Solutions
CST of America, Inc.
Electronics Test Centre (Kanata)
ETS-Lindgren
National Technical Systems
TUV SUD America Inc.
Visron Design, Inc.

CONSULTANTS

Captor Corp.
D.A.R.E!! Instruments
D.L.S. Electronic Systems, Inc.
DNB Engineering, Inc.
Don HEIRMAN Consultants
Elite Electronic Engineering Co.
EM Software & Systems
EMC Cons Dr. Rasek GmbH
EMC Management Concepts
EMCC Dr. Rasek
EMCMCC
EMITEMC
Equipment Reliability Institute
ERA Technology Ltd. Trading as
Cobham Technical Services
ETS-Lindgren
Henry Ott Consultants
Hoolihan EMC Consulting
ITEM Media
Kimmel Gerke Associates, Ltd.
Montrose Compliance Service,
Inc.
MOOSER Consulting GmbH
NewPath Research L.L.C.
Paladin EMC
Power & Controls Engineering
Ltd.
Power Standards Lab (PSL)
Radiometrics Midwest Corp.
Retlif Testing Laboratories
TUV SUD America Inc.
Wyatt Technical Services LLC

DIRECT LIGHTNING TESTING

DNB Engineering, Inc.
Electronics Test Centre (Kanata)
National Technical Systems
TUV SUD America Inc.

ELECTROSTATIC DISCHARGE (ESD) TESTING

D.L.S. Electronic Systems, Inc.
DNB Engineering, Inc.
Elite Electronic Engineering Co.
Radiometrics Midwest Corp.
Retlif Testing Laboratories
TUV SUD America Inc.

EMISSIONS TESTING

Captor Corp.
D.A.R.E!! Instruments
D.L.S. Electronic Systems, Inc.
DNB Engineering, Inc.
Don HEIRMAN Consultants
Electronics Test Centre (Kanata)
Elite Electronic Engineering Co.
maturro GmbH
Mitsubishi Digital Electronics
America Inc.
Montrose Compliance Service,
Inc.
National Technical Systems
Radiometrics Midwest Corp.
Retlif Testing Laboratories
TUV SUD America Inc.
V-Comm, LLC

EMP, SGEMP SYSTEM ASSESSMENT

DNB Engineering, Inc.
Kimmel Gerke Associates, Ltd.
National Technical Systems

EMP/LIGHTNING EFFECTS TESTING

D.L.S. Electronic Systems, Inc.
DNB Engineering, Inc.
Electronics Test Centre (Kanata)
Elite Electronic Engineering Co.
National Technical Systems
Radiometrics Midwest Corp.
Retlif Testing Laboratories
Teseq
TUV SUD America Inc.

ENVIRONMENTAL TESTING

D.A.R.E!! Instruments
D.L.S. Electronic Systems, Inc.
Elite Electronic Engineering Co.
National Technical Systems
TUV SUD America Inc.

EUROPEAN CERTIFICATION TESTING

D.A.R.E!! Instruments
D.L.S. Electronic Systems, Inc.
DNB Engineering, Inc.
Electronics Test Centre (Kanata)
Elite Electronic Engineering Co.
EMC Testing Laboratories, Inc.
EU Compliance Services, Inc.
F-Squared Laboratories
GTN GmbH & Co. KG
INTERTest Systems, Inc.
ITL Israel
Montrose Compliance Service
National Technical Systems

Radiometrics Midwest Corp.
Retlif Testing Laboratories
TUV Rheinland Of North America
TUV SUD America Inc.

FCC PART 15 & 18 TESTING

D.A.R.E!! Instruments
D.L.S. Electronic Systems, Inc.
DNB Engineering, Inc.
Don HEIRMAN Consultants
Electronics Test Centre (Kanata)
Elite Electronic Engineering Co.
Montrose Compliance Service
National Technical Systems
Radiometrics Midwest Corp.
Retlif Testing Laboratories
TUV SUD America Inc.

FCC PART 68 TEST EQUIPMENT

DNB Engineering, Inc.
EM Test USA
EMC Partner AG
HV Technologies, Inc.
Retlif Testing Laboratories

GROUNDING SERVICES

Intermark (USA) Inc.

IMMUNITY TESTING

A.H. Systems, Inc.
D.A.R.E!! Instruments
D.L.S. Electronic Systems, Inc.
DNB Engineering, Inc.
Electronics Test Centre (Kanata)
Elite Electronic Engineering Co.
LEDE-SIECIT
National Technical Systems
Radiometrics Midwest Corp.
Retlif Testing Laboratories
Teseq
TUV SUD America Inc.

ISO 9000 TESTING

Electronics Test Centre (Kanata)
National Technical Systems
Swift Textile Metalizing LLC
TUV SUD America Inc.

LIGHTNING STRIKE TESTING

D.L.S. Electronic Systems, Inc.
DNB Engineering, Inc.
Elite Electronic Engineering Co.
National Technical Systems
Pearson Electronics, Inc.
Radiometrics Midwest Corp.
Retlif Testing Laboratories
TUV SUD America Inc.

LIBERTY LABS, INC. & WORLD CAL, INC.

Our Team Provides Onsite Calibration Services



Quality Onsite Calibration Services:

- * Fully Self-Contained
- * Temperature, Humidity & ESD Controlled
- * Independent Renewable Energy Powered Calibrations
- * You'll receive the same quality & service from our fixed locations in Kimballton, IA & Elk Horn, IA

Our Onsite Calibrations Provide the Following:

- * Times to suit your schedule
- * At your place of business
- * Quick turn around time
- * Specializing in RF, Burst & Surge Generators, Flicker Harmonics, & Renewable Energy Instrumentation Calibrations
- * ISO 17025 Accredited Calibrations
- * Nationwide Coverage
- * We can calibrate your equipment in our mobile lab or within your facility

Please call for more information or check out our website!

Liberty Labs, Inc.
1346 Yellowwood Road, PO Box 230
Kimballton, IA 51543
PH: 712-773-2199 FAX: 712-773-2299
Website: www.liberty-labs.com
Email: info@liberty-labs.com

World Cal, Inc.
2012 High Street, PO Box 410
Elk Horn, IA 51531
PH: 712-764-2197 FAX: 712-764-2195
Website: www.world-cal.com
Email: info@world-cal.com

MIL-STD 188/125 TESTING

DNB Engineering, Inc.
Elite Electronic Engineering Co.
National Technical Systems

MIL-STD 461 / 462 TESTING

D.L.S. Electronic Systems, Inc.
DNB Engineering, Inc.
Electronics Test Centre (Kanata)
Elite Electronic Engineering Co.
EMC Compliance
Harris Corp (GCSD)
National Technical Systems
Retlif Testing Laboratories
Radiometrics Midwest Corp.
TUV SUD America Inc.
Wyle

NAVLAP / A2LA APPROVED TESTING

A2LA
ATLAS Compliance & Engineering
Bay Area Compliance Labs Corp.
Compliance Management Group
D.L.S. Electronic Systems, Inc.
DNB Engineering, Inc.
Electronics Test Centre (Kanata)
Elite Electronic Engineering Co.
Liberty Labs, Inc.
National Technical Systems
NU Laboratories
Radiometrics Midwest Corp.
TUV SUD America Inc.

PRODUCT SAFETY TESTING

D.A.R.E!! Instruments
D.L.S. Electronic Systems, Inc.
DNB Engineering, Inc.
Electronics Test Centre (Kanata)
Elite Electronic Engineering Co.
Montrose Compliance Service
National Technical Systems
Retlif Testing Laboratories
TUV SUD America Inc.

RADHAZ TESTING

DNB Engineering, Inc.
Electronics Test Centre (Kanata)
Retlif Testing Laboratories

RS03 > 200 V / METER TESTING

D.L.S. Electronic Systems, Inc.
DNB Engineering, Inc.
Electronics Test Centre (Kanata)
Elite Electronic Engineering Co.
National Technical Systems
Radiometrics Midwest Corp.
Retlif Testing Laboratories
TUV SUD America Inc.

RTCA DO-160 TESTING

D.L.S. Electronic Systems, Inc.
DNB Engineering, Inc.
Electronics Test Centre (Kanata)
Elite Electronic Engineering Co.
National Technical Systems
Radiometrics Midwest Corp.

Retlif Testing Laboratories
TUV SUD America Inc.

SHIELDING EFFECTIVENESS TESTING

D.A.R.E!! Calibrations
D.L.S. Electronic Systems, Inc.
DNB Engineering, Inc.
Dontech, Inc.
Electronics Test Centre (Kanata)
Elite Electronic Engineering Co.
ETS-Lindgren
Federal-Mogul Corporation
Systems Protection
National Technical Systems
Radiometrics Midwest Corp.
Retlif Testing Laboratories
TUV SUD America Inc.

SITE ATTENUATION TESTING

D.A.R.E!! Calibrations
D.L.S. Electronic Systems, Inc.
DNB Engineering, Inc.
Electronics Test Centre (Kanata)
ETS-Lindgren
National Technical Systems
Radiometrics Midwest Corp.
Retlif Testing Laboratories

SITE SURVEY SERVICES

D.A.R.E!! Calibrations
D.L.S. Electronic Systems, Inc.
DNB Engineering, Inc.
Electronics Test Centre (Kanata)
Elite Electronic Engineering Co.
ETS-Lindgren
Kimmel Gerke Associates, Ltd.
National Technical Systems
Radiometrics Midwest Corp.
Retlif Testing Laboratories

TELCORDIA TESTING

D.L.S. Electronic Systems, Inc.
DNB Engineering, Inc.
Electronics Test Centre (Kanata)
National Technical Systems
Radiometrics Midwest Corp.

TEMPEST TESTING

National Technical Systems

TESTING

3C Test Ltd. - EMC Testing
A.H. Systems, Inc.
A2LA
Acme Testing Company
Advanced Compliance Solutions, Inc.
Advanced Testing Services
AERO NAV Laboratories
AHD EMC Lab / Amber Helm Development L.C.
Alion Science and Technology
American Environments Co., Inc.
Applied Physical Electronics, L.C.
ATLAS Compliance & Engineering

BEC Inc.
Blackwood Labs
Blue Guide EMC Lab
Braco Compliance Ltd.
Bureau Veritas (formerly Curtis-Straus)
Cascade TEK
CertifiGroup
CETECOM Inc.
CKC Laboratories, Inc.
Communication Certification Laboratory
Compatible Electronics, Inc.
Compliance Certification Services
Compliance Engineering Ireland Ltd.

Compliance Management Group
Compliance Testing LLC
Compliance Worldwide
Core Compliance Testing Services
Cranage EMC Testing Ltd.
Criterion Technology, Inc.
CSA International
Custom Assembly LLC
D.A.R.E!! Calibrations
D.L.S. Electronic Systems, Inc.
Dayton T. Brown, Inc.
dBi Corp.

Diversified T.E.S.T. Technologies
DNB Engineering, Inc.
Don HEIRMAN Consultants
E.F. Electronics Co.
E-Labs Inc.
ElectroMagnetic Investigations, LLC

Electro Magnetic Test, Inc.
Electro Rent Corporation
Elite Electronic Engineering Co.
EM Software & Systems
EMC Compliance
EMC Integrity, Inc.
EMC Technologies Pty Ltd.
EMC Tempest Engineering
EMC Testing Laboratories, Inc.

EMCC Dr. Rasek
EMCMCC
EMF Testing USA
EMField
EMITECH

Enerdoor Inc.
Engineered Testing Systems
Environ Laboratories, LLC
ETS-Lindgren
Fabreeka International, Inc.
Federal-Mogul Corporation
Systems Protection
Global Advantage
Global Certification Laboratories, Ltd.

Global Testing
Green Mountain
Electromagnetics, Inc.
GTN GmbH & Co. KG
H.B. Compliance Solutions
Harris Corp (GCSD)
Hermon Laboratories
iNARTE, Inc.

Ingenuum Testing, LLC
International Certification Services, Inc.
International Compliance Laboratories, LLC
Intertek Testing Services
IQS, a Div. of The Compliance Management Group
ITC Engineering Services, Inc.
Jacobs Technology Inc.
JS TOYO Corporation (Shenzhen) Ltd.

Keystone Compliance
Kimmel Gerke Associates, Ltd.
L.S. Research
L-3 Communications Cincinnati Electronics
Laboratory Testing Inc.
Langer EMV-Technik GmbH
LF Research EMC
Liberty Labs, Inc.

Little Mountain Test Facility
Mesago Messe Frankfurt GmbH
MIRA Ltd.
National Technical Systems
Naval Air Systems Command
Naval Air Warfare Center

NCEE Labs
Nemko USA
Northwest EMC, Inc.
NU Laboratories
Paladin EMC
Parker EMC Engineering
Peak Electromagnetics Ltd.
Pearson Electronics, Inc.
Percept Technology Labs, Inc.
Philips Applied Technologies - EMC Center
Philips Innovation Services-EMC Center

Pioneer Automotive Technologies, Inc. - EMC Lab
Power-Electronics Consulting
Product Safety Engineering Inc.
Protocol Data Systems Inc.
Pulver Laboratories Inc.

QinetiQ
Qualtest Inc.
Radiometrics Midwest Corp.
Remcom Inc.

Restor Metrology
Retlif Testing Laboratories
RF Exposure Lab, LLC
RFI Global Services Ltd.
RFTEK
Rhein Tech Laboratories, Inc.
Rogers Labs, Inc.
Rubicom Systems, A division of ACS
SAE Power
Seven Mountains Scientific, Inc. (ENR)

SGS
SIEMIC
Southwest Research Institute
SPAWAR Systems Center
Atlantic
Swift Textile Metalizing LLC
Sypris Test and Measurement

TEMPEST Inc.
 Teseq
 Test Site Services Inc.
 The Compliance Management Group
 Timco Engineering, Inc.
 TRaC Global
 Trialon Corp.
 TÜV Rheinland Of North America
 TÜV SUD America Inc.
 TÜV SÜD Product Service Ltd.
 TÜV SÜD SENTON GmbH
 Ultratech Group of Labs
 Underwriter's Laboratories Inc.
 Walshire Labs, LLC
 Washington Laboratories, Ltd.

White Sands Missile Range
 Willow Run Test Labs, LLC
 Wyle
 Yazaki Testing Center
 D.A.R.E!! Instruments

TESTING LABORATORIES

Alion Science and Technology
 AT4 Wireless
 Blue Guide EMC Lab
 Compliance Testing LLC
 Compliance Worldwide
 D.A.R.E!! Instruments
 D.L.S. Electronic Systems, Inc.
 Diversified T.E.S.T. Technologies

DNB Engineering, Inc.
 Don HEIRMAN Consultants
 Electro Magnetic Test, Inc.
 Electronics Test Centre (Kanata)
 Elite Electronic Engineering Co.
 EMC Integrity, Inc.
 EMC Technologies Pty Ltd.
 H.B. Compliance Solutions
 International Compliance Laboratories, LLC
 Keystone Compliance
 Langer EMV-Technik GmbH
 Liberty Labs, Inc.
 National Technical Systems
 Partnership for Defense Innovation
 Professional Testing (EMI), Inc.

Qualtest Inc.
 Radiometrics Midwest Corp.
 Retlif Testing Laboratories
 RMV Technology Group, LLC
 SDP Engineering Inc.
 SIEMIC
 Sprinkler Innovations
 Stork Garwood Laboratories Inc.
 Test Site Services Inc.
 Tranzeo EMC Labs Inc.
 TÜV SÜD America Inc.
 TÜV SÜD Product Service Ltd.
 TÜV SÜD SENTON GmbH
 World Cal, Inc.

CONSULTANT SERVICES

KIMMEL GERKE ASSOCIATES, LTD.
Consulting Engineers
EMI DESIGN & TROUBLESHOOTING

- **EMI Design and Systems Consulting**
 -Regulations - Emissions - RFI - ESD - Power Disturbances
- **EMI Seminars**
 -Design - Systems - Custom - Public and Private
- **EMI Design Reviews**
 -Circuit Boards - Cables - Power - Grounding - Shielding
- **EMI - Toolkit@** - An EMI Software "Reference Handbook"

Daryl Gerke, PE
 2538 W. Monterey Ave.
 Mesa, AZ 85202

William Kimmel, PE
 628 LeVander Way
 S. St. Paul, MN 55075

www.emiguru.com • 1-888-EMI-GURU



Hoolihan EMC Consulting

Daniel D. Hoolihan
 32515 Nottingham Court
 P.O. Box 367
 Lindstrom, MN 55045

Phone 651-213-0966
 Fax 651-213-0977
 Cell Phone 651-269-3569
 e-mail hoolihan@emcexpert.com
 web page www.emcexpert.com
 e-mail danhoolihanemc@aol.com



Montrose Compliance Services, Inc.
Electromagnetic Compatibility and Product Safety

Mark I. Montrose

Consulting and Design Services Seminars (In-house/Private)
 Printed Circuit Board Layout and Design for SI/EMI/EMC
 In Situ CE Test Laboratory (ISO 17025 Assessed)
 Specializing in ITE and Industrial Products for CE Compliance

www.montrosecompliance.com
 2353 Mission Glen Drive and FAX +1 (408) 247-5715
 Santa Clara, CA 95051-1214 mmontrose@earthlink.net

Don HEIRMAN Consultants, L.L.C.

Donald N. Heirman, NCE
 President

143 Jumping Brook Road +1 732-741-7723 (Voice)
 Lincroft, NJ 07738-1442 USA +1 732-530-5695 (FAX)
 d.heirman@ieee.org
 http://www.DonHEIRMAN.com

973-992-1793 FAX 973-533-1442

HENRY OTT CONSULTANTS
 EMC CONSULTING & TRAINING
 www.hottconsultants.com

48 BAKER RD.
 LIVINGSTON, NJ 07039

h.ott@verizon.net
HOC
 ELECTROMAGNETIC
 COMPATIBILITY

Reliability is



the Answer

All Roads
lead to



Solid State Microwave Power Amplifiers

Model Number	Frequency Range (GHz)	Rated Power (Watts) Min.	P1dB Power (Watts) Min.	Gain (dB) Min.
S31-5	0.8-3.0	5	5	37
S31-10	0.8-3.0	10	8	40
S31-20	0.8-3.0	20	15	43
S31-25	0.8-3.0	25	20	44
S31-40	0.8-3.0	40	30	46
S31-50	0.8-3.0	50	40	47
S31-75	0.8-3.0	75	60	49
S31-100	0.8-3.0	100	80	50
S31-150	0.8-3.0	150	130	52
S31-200	0.8-3.0	200	150	53
S31-250	0.8-3.0	250	200	54
S31-300	0.8-3.0	300	250	55
S31-400	0.8-3.0	400	350	56
S31-500	0.8-3.0	500	450	57

IFI Offers Innovative Amplifier Solutions for every EW & ECM testing application, DC to 40 GHz, 1 watt to 50 Kilowatts. That's what makes us...

The POWER OF CHOICE!



INSTRUMENTS FOR INDUSTRY

903 South Second Street • Ronkonkoma, NY 11779
Tel: 631-467-8400 • Fax: 631-467-8558 • E mail: sales@ifi.com • www.ifi.com

DEPENDABILITY

Starts With Equipment
That Works The Way You
Expect It To!

IFI Offers Innovative Amplifier Solutions for
every EMC & EMI testing application,
DC to 40 GHz, 1 watt to 50 Kilowatts.

That's what makes us...

The POWER OF CHOICE!



Solid State RF Power Amplifiers

Model Number	Frequency Range	Rated Power (Watts) Min.	P1dB Power (Watts) Min.	Gain (dB) Min.
SCDX10	10KHz-400MHz	10	10	40
SCDX25	10KHz-400MHz	25	25	44
SCDX50	10KHz-400MHz	50	50	47
SCDX100	10KHz-400MHz	100	80	50
SCDX150	10KHz-400MHz	150	100	52
SCDX200	10KHz-400MHz	200	160	53
SCDX250	10KHz-400MHz	250	200	54
SCDX350	10KHz-400MHz	350	280	56
SCDX500	10KHz-400MHz	500	300	57



INSTRUMENTS FOR INDUSTRY

The Urgent Need to Integrate EMC and Product Safety into Engineering Curriculum of Technical Universities

ANTHONY A. DIBIASE
Spec-Hardened Systems
Rochester, New York USA

There is an evolution in the study of electromagnetic field effects on electrical and electronic products and systems. It is progressing from engineering art to an engineering science. The complexity and sophistication of newer technology products has added to an increased need for more consideration of EMC and Product Safety issues. These factors have increased the requirement for technical universities to implement studies of electromagnetic fields and Product Safety into their engineering programs. EMC and Product Safety factors are essential elements in product designs and their required regulatory certification requirements.

INTRODUCTION

The lack of adequate EMC and Product Safety design and development education at the university level is contributing to an erosion of the United States (US) technical and export capabilities. At the present time this field of study is not a standard requirement in the engineering programs of universities. A comprehensive knowledge in the disciplines of electrical, mechanical, chemical, and computer science are required as a prerequisite base for performing design and certification tasks related to EMC and Product Safety.

The study requirements for EMC and Product Safety engineering programs have a very good fit with existing electrical engineering programs since the required curriculum prerequisite courses already exist within the engineering programs. Engineers whose responsibilities include the design and development of electrical and electronic products and systems must meet the product's functional, interoperability, self-compatibility, and their regulatory certification requirements. They must have the educational and experience background to effectively perform these tasks.

EDUCATIONAL RESOURCES PRESENTLY AVAILABLE

At the present in the US there are a limited number of resources available to engineering personnel for obtaining education in the areas of EMC and Product Safety studies. There is a varied amount of university level involvement in EMC and Product Safety training being conducted currently in the US. Among those that have provided or are providing such training in related studies are listed below.

- Clemson University (Vehicle Electronics Laboratory –CVEL) – The Clemson University automotive engineering program awards degrees for a curriculum that includes EMC studies. These studies include courses in the development of EMC computer program modeling. The university has been involved in EMC research projects for over 20 years.
- University of Missouri of Science

FRUSTRATED WITH TEDIOUS SEARCHES FOR EMC PRODUCTS & SERVICES? **CHECK OUT OUR NEW BUYERS' GUIDE**

- WATCH PRODUCT DEMOS
- VIEW PRODUCT DESIGNS
- READ THE LATEST PRODUCT SPECS
- SHARE INFO WITH YOUR COLLEAGUES

■ **SEARCH IT NOW**
interferencetechnology.com

EMC

interference technology

THE INTERNATIONAL JOURNAL OF
ELECTROMAGNETIC COMPATIBILITY

ITEM
MEDIA



and Technology at Rolla – The university has recently opened a new EMC research center in partnership with a major corporation involving an aviation research project.

- University of Michigan – The university is working in conjunction with The Society of Automotive Engineers of Eastern Michigan, a Chapter of the IEEE's EMC Society. The university is involved in cosponsoring seminars that are related to EMC considerations in automotive systems.

- University of Wisconsin at Milwaukee College of Engineering – Has been sponsoring seminars related to EMC topics.

- George Washington University Center for Professional Development – The university has presented educational seminars on EMC related subjects.

- The University of California at Los Angeles (UCLA) – Has a program that awards certificates in EMC studies.

- Oklahoma State University – Presents short courses covering EMC topics and testing considerations.

Universities with engineering programs should consider taking advantage of the IEEE EMC Society's University Grant Program. This program provides funding to those universities to aid them in introducing EMC training into their engineering curriculum. Universities can apply for these grants though the society's grant program and a number of universities have already done so.

Other venues for EMC and Product Safety education are available though various seminars and training programs presented by different related corporate services and consulting organizations.

There are universities though out the U.S. which have EMC related activities as part of their educational and research programs. There is a considerable amount of activity occurring in the realm of university research projects that is sponsored by the U.S. government agencies. Among these research projects is one that involves a research study to develop counter measures against improvised explosive devices (IED's) that are used against our military. Other projects in this category that are being worked on are electromagnetic weapons that include electromagnetic pulse and microwave weapon systems. Also, there are university research projects that aimed at assessing the effects of electromagnetic fields on the safety of humans and animals. In another category there are university EMC related research efforts being conducted for industry via university industry partnerships. The study requirements for EMC Engineering programs has a very good fit with existing electrical engineering programs since the required curriculum prerequisite courses already exist in that engineering program.

WHERE A FORMAL EDUCATION IS REQUIRED

There are many EMC and Product Safety challenges facing engineers responsible for the design and development of modern day electrical and electronic products and systems. Meeting regulatory certification regulatory compli-

ance is one of them. As an example regulatory compliance requirements are becoming ever more demanding and difficult to meet. The European Union (EU) CE Mark EMC testing requirements are a good example of this fact. The following EMC conformity requirements are applicable for regulatory certification of various electrical and electronic products and systems.

- Electrostatic Discharge (ESD)
- Power Quality Effects factors (PQF)
- Electrical Fast Transient Effects (EFT)
- Radiated Emissions Limits (RE)
- Conducted Emissions Limits (CE)
- Radiated Immunity Limits (RI)
- Conducted Immunity Limits (CI)
- Magnetic Field Effects (H-Field)

The design engineer must be proficient in applying the required mitigating techniques required allowing his product or system to be compatible with these requirements. Some of the Electromagnetic Emissions (EMI) mitigating methods that can be used are, the application of shielding, filtering, optimizing of the grounding design, and applying the correct set of EMC design guideline rules.

Small and medium companies, for the most part, do not have the engineering personnel available who have the knowledge base to perform the required EMC tasks due to their lack of education and experience needed to perform these tasks. The use of consultants is most often the chosen course of action. The added costs related to use of consulting services limits the ability of these companies to be cost competitive in their efforts to export their products globally.

GLOBAL ECONOMIC FACTORS

While the US is currently in a slow growth economic period other country such as The People's Republic of China, India, Brazil and Russia have economies that are growing at a much faster rate (between 5 and 9 %). This leads to the fact that US manufacturers must look increasingly to exporting their products in order to maintain their profitability. Impeding their ability to be competitive in the international market place is the lack of an adequate pool of educated and experienced EMC and Product Safety Engineers.

More often then not EMC and Product Safety design issues are dealt with in the later stages of the product's design cycle when they are more difficult to fix and are accompanied by greater costs and schedule delays. As companies off shore more and more of their product design, development, and certification activities the result is a diminishing of US's economic capabilities.

EMC and Product Safety requirements are also important considerations for products sold in the US's domestic market. This is true since the Federal Communications Commission (FCC) enforces radiated emissions limit requirements on most electrical and electronic products. They also have strict EMC certification requirements on telecommunication equipment. The Federal Drug

Admiration (FDA) applies several International Electro-technical Commission (IEC) standards requirements on US medical products. As for Products safety certifications there is always the issue of product legal liability considerations to be deal with and the loss of product reputation.

CONCLUSIONS

While there are various sources of EMC and Product Safety educational programs available to engineers, the requirement for a comprehensive formal educational program at the university level is urgently needed. In the years to come, EMC engineering will continue to evolve from an engineering art to an engineering science. Therefore, the need for the understanding of the theoretical and the practical application of EMC principles becomes more essential. It needs to become an integral part of the electrical engineering curriculum.

In the future as device frequencies exceed the 40 GHz level it will present a greater challenge to EMC engineers. Therefore, the need for formally trained and experienced EMC engineers will become more of necessity then an option. At the present time the prevailing view is that EMC engineering entails working with a very complex and intuitively drive science and that only through years of experience can it be mastered in an effective manner. The fast pace of technological advancements and the rapid

development of a complex global economy does not allow the luxury of gaining the required years of EMC experience. A formal education must be provided to engineering students to provide them with the required knowledge foundation to work effectively in the engineering field of EMC.

ANTHONY DiBIASE is the president of Spec-Hardened Systems an EMC and Product Safety consulting firm. He is a graduate of The Rochester Institute of Technology and holds a BSEE degree. He has presented several seminars, training programs, and written articles on the topics of EMC and Product Safety. He can be contacted by e-mail at SHSESC@aol.com.

YOUR WEEKLY EMC UPDATE

Interference Technology eNews provides news, standards updates, buyers' guides, product developments and more direct to your inbox once a week. Join the growing number of subscribers to stay up to date – subscribe online today.

www.interferencetechnology.com



EMC TESTING LEADERSHIP & ENGINEERING SUPPORT...

IN-LAB or ON-SITE ... RETLIF is READY, WILLING & ABLE.

*We're ready...with state-of-the-art equipment in our three labs.
We're willing...with dedicated, highly trained staff.
We're able...with in-house engineering support.*

Count on Retlif's EMC and lightning testing services to national and international standards. Trust your equipment and systems to us for shielded effectiveness testing, EMP, high level radiated susceptibility testing and low noise level emissions testing. Leading military, aerospace, commercial and industrial companies have, for over 30 years.

■ **FULLY ACCREDITED TO OVER 350 EMC TEST METHODS.**

RETLIF TESTING LABORATORIES

Put us to the testSM

795 Marconi Avenue • Ronkonkoma, NY 11779
TEL: (631) 737-1500 • FAX: (631) 737-1497 • www.retlif.com

Additional locations in New Hampshire, North Carolina, Pennsylvania & Washington D.C.

Christmas Music in the Chamber

How a sprinkler system brought radio noise to a chamber and the techniques used to find and remove it

CANDACE SURIANO

JOHN SURIANO

Auburn Hills, Michigan, USA

Anechoic and semianechoic or ALSE (Absorber Lined Shielded Enclosure) chambers are supposed to prevent radio signals and other radiated noise in the environment from being detected inside the chamber. A chamber that lets in ambient radiation is not useful for emissions testing. This article covers how a sprinkler system brought Christmas radio noise to a chamber and the techniques we used to find and remove the noise. In this case the spirit of Christmas was a little too much for the EMC engineers to bear. This is how we brought some Christmas cheer back to their last-minute end-of-year testing.

It was Christmas time; the FM radio station broadcasting nearby to our friends' chamber was showing up like the Sears tower in the test ambient. The test engineers that ran the ALSE cleaned the fingers around the door to try to get rid of the radio signal but there was no change in the noise picked up by the biconical antenna. After some experiments they determined that the noise was mostly vertically polarized. Our friends called us and asked us to come help them. We came with an MP3 player with an FM tuner, a spectrum analyzer, an amp and probes.

A handheld radio with a digital tuner is often the best tool for picking up spurious signals in the AM (535-1700 kHz) and FM (88-108MHz) bands. Many times we have

found the source of a radio signal by tracing it with a handheld radio. For example, if you are looking for broadband noise, an AM radio can be used. Tune the radio to the AM band where there is no station that can be heard. Broadband noise will come in easily on the AM radio. This is a great way to trace wires in a wall. In this case, though, the problem was FM radio stations so we thought we might just be able to pick them up in the chamber with the handheld radio.

The chamber's door was hanging slightly off vertical and was not properly seated by about a fourth of an inch at the top. We

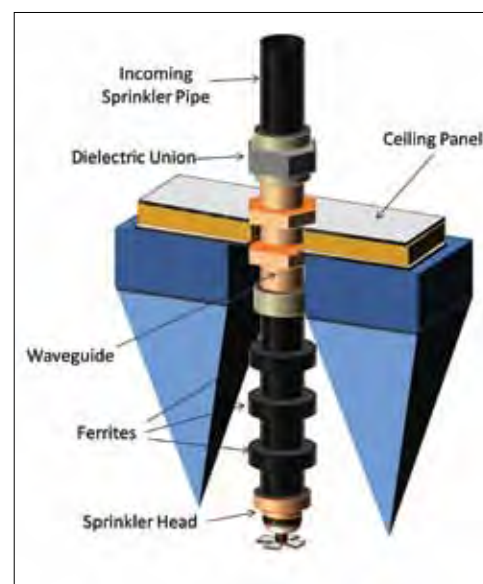

Figure 1. Construction of sprinkler at anechoic chamber ceiling.

Call Today... Start Testing Tomorrow with DNB Engineering

24 Shielded Chambers - 48,000 sq.ft. of Test Laboratories - 32 Years in the Test Business
NARTE-Certified Engineering Staff - Extensive Major Program Experience - Competitive Pricing

Solutions for all your qualification needs – DNB Engineering is your natural choice!

DNB is a world leader and recognized expert in certification testing. We provide unrivaled testing services for both Direct and Indirect Lightning and HIRF (High Intensity Radiated Fields). We have the largest commercially available Mode Tuned Chamber for HIRF testing in North America. **Our Mode Tune Chamber has 2,500 cubic feet of uniform field area.** Large or unusual test requirements and fast turnarounds are our specialty.

DNB's Unique Testing Capabilities:

HIRF Testing

- 25' x 30' x 14' Mode Tuned Chamber with 18' x 15' x 9' Uniform Field Area
- **10KW TWT Amplifiers (up to 10,000 V/m)**
- DO-160 F Categories G and L
3000 V/m, 7200 V/m
- 100MHz – 40GHz
- High Level HIRF and Radiated Susceptibility Testing – CW, SW & Pulse
- 480V/200A Power Available
- Permanent Reference Antennas for Real-time Field Monitoring
- MIL-STD-461/464

Lightning Testing

- Direct Effect – DO-160 Sec. 23
- All Waveforms, All Voltages
- ARP 5412, ARP 5416
- European Equivalents
- Indirect Effect – DO-160 Sec. 22
- Up through Level 5 and Beyond
- **Cable Induced WF 5 at Level 5**
- Custom Wave Forms

Full-time Test Engineers
on Staff

Yes We
Can Do It!

Give us your next challenge

Call at **1-800-282-1462** for a free quote
or visit us at www.dnbenginc.com and fill out a proposal request.

We've expanded significantly over the last few years to meet industry demand.
If you don't know us, please call us or come visit our facility.

What's NEW at DNB

- Solar Radiation Testing
- Sand & Dust Testing per MIL-STD-810G

We also provide in-house services for your other certification needs:

- EMC Testing – DO-160 and MIL-STD 461
- ESD Testing
- Connector Testing
- Environmental Testing – DO-160 and MIL-STD 810
- Product Safety Testing
- Test Consulting
- Design Engineering

We've been in business since 1979 and we're family-owned.



Full size automobile inside 25' x 30' x 14' Mode Tuned Chamber



DNB Engineering, Inc.
"One World, One **EMC** Solution"

Four offices to serve you...
Fullerton CA (2) | Riverside CA | Coalville UT



Fullerton, CA - Lab Code 200953-0
Riverside, CA - Lab Code 200587-1
Coalville, UT - Lab Code 200634-0





2a



2b

Figure 2. Condition of sprinkler condition at top of chamber. (a) Corrosion at one of the waveguides on top of the chamber. (b) The same waveguide after cleaning. Brass wool can be seen between the waveguide nut and the chamber surface.



3a



3b

Figure 3. Condition of panel joint at top of chamber. (a) Corrosion on the top of the chamber due to pooled water. The corrosion extends to one of the panel joints. (b) Copper tape was used to bridge between the joint and the chamber panel after corrosion was cleaned away. Corrosion under the joint could not be cleaned.

first covered the edges of the door with aluminum foil that contacted with the door edge and the chamber. We had them run an ambient scan and there was no change in the noise that reached the biconical antenna. The FM music showed up on the peak and the average line traces.

We moved our search into the chamber. We brought the spectrum analyzer, amp, probes and FM radio into the chamber. We tried locating the noise source with the FM radio. A check with the FM radio receiver did not reveal anything because the signal was too weak to detect. Unfortunately in retrospect, the MP3 player was doomed to failure for lack of a more substantial antenna. Perhaps we would have had more success with a boom box with an extendable monopole. So we gave up on the radio and tried to use the probes.

We let the spectrum analyzer, amp and probes warm up after sitting outside in our car trunk. Electronics are sensitive to temperature and it is wise to allow them to come to room temperature before using them. We tried

to pick up the signal with the commercial near field probe but the strength was too low even with the amplifier to be useful. We were hoping to use the probes to find some section of the door, cables, or other ingress/egress points that might be leaking. Finally we had to resort to using an actual EMI receiver in conjunction with our amp. We climbed high on ladder next to some of the nine sprinkler heads and low next to the corners and the door. We were not able to check all the corners because of the equipment that was in the room, including the difficulty of manipulating a tall ladder near cones. We were not able to find the FM signal with the door closed. The probes and amp' even with the EMI receiver were not sensitive enough to find the FM signal.

We next replaced the probes with a coaxial cable having alligator clip leads to make a short dipole antenna. Even though its length was not optimized it was able to pick up the signal. In this case we were hoping that the since our crude dipole "probe" was small it might be able to

SOMETIMES **UNCERTAINTY** CAN BE EXCITING. **NOT IN EMC.**



PMM EMI receivers reduce the uncertainty sources. Definitely.

EMI receivers up to 18 GHz fully compliant to CISPR and MIL-STD. Antenna-mounted remote unit with fiber optic digital link.

Narda Safety Test Solutions srl

Via Leonardo da Vinci, 21/23

20090 Segrate (MI) ITALY

Phone: +39 02 26 998 71

Fax: +39 02 26 998 700

E-Mail: support@narda-sts.it

www.narda-sts.it

PMM

a brand of

narda
Safety Test Solutions®
an L3 Communications Company

*Names and Logo are registered trademarks of Narda Safety Test Solutions GmbH and L3 Communication Holdings, Inc. - Trade names are trademarks of the owners.

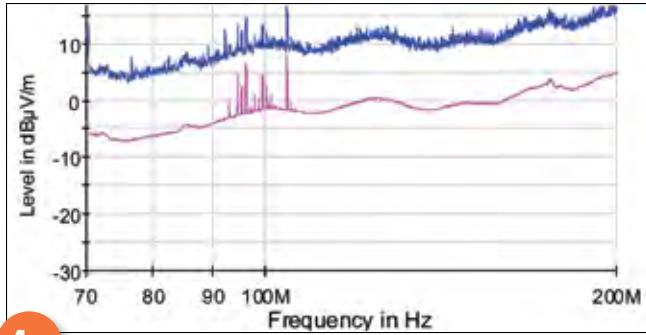

4a

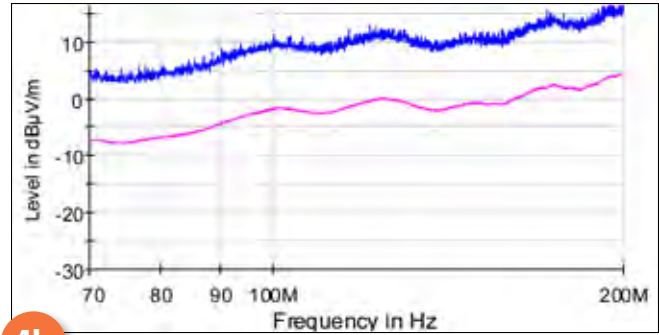

4b

Figure 4. Ambient Measurements. (a) Ambient measurement in the FM band before the sprinklers were fixed (blue is Peak and pink is Average detection); (b) Ambient measurement in the FM band after sprinklers were fixed.

resolve the location of the leak. However, there was too much variation in the signal resulting from the proximity of the wires to the person holding the cable and from the flopping of the wires to be able to make any conclusions.

Finally we had to resort to using the biconical antenna with the amplifier connected to the EMI receiver inside the room. A biconical antenna is usually useful between 20 and 300MHz, designed to pick up the FM radio stations that were plaguing it. Leaving the antenna on the tripod in the vertical orientation and locating it at vari-

ous spots in the room it became very evident that the signal was coming mostly in through the center sprinkler head which was located directly above the normal test location of the antenna. Every sprinkler head had three very large ferrite rings. We tried moving all the ferrites on the center sprinkler head to one spot on the pipe and the noise became stronger. The two other sprinklers on the sides of the center sprinkler head had weaker FM signals. We wiggled the center sprinkler increasing the conductivity and the FM Christmas music disappeared. We were enthusiastic; it looked like there was a problem with a connection on the top of the chamber that we could easily solve by improving the electrical contact. The many components of a typical chamber sprinkler feed are shown in Figure 1. The brass waveguide provides the necessary electrical grounding of the sprinkler pipe to the chamber, allows for water flow to the sprinkler head, and blocks noise from coming through the hole that must be cut to allow passage of the pipe into the room. If the waveguide is not electrically contacting the chamber walls, then the sprinkler pipe can conduct radio stations into the room.

Up on top of the chamber it was easy to see the root cause of the problem. Chamber sprinklers are a disaster waiting to happen. The fire marshal requires that the system must be tested every year. During the testing sometimes the pipe connections may leak. This can spell catastrophe for an ALSE if the water leaks. This sprinkler system had leaked at some time in the past. The leakage was on the chamber roof at a connection to one of waveguides or its associated dielectric union but no one had known it. The water pooled all the way over to the center sprinkler and corroded the metal on the chamber ceiling panel beneath the brass nut that tightens the waveguide to the panel. Imagine what kind of monetary loss would have been involved if a larger leak had occurred and the panel joints became corroded. It is a good practice to periodically inspect the top of the chamber for sprinkler leaks or even for leaks from the roof. In one instance we are familiar with, a roof leak destroyed several panels on a reverberation chamber ceiling before it was noticed. In

EMC COMPLIANCE CENTER
Specialists in solving a wave of EMI compliance problems.

- A2LA Accredited
- "CE" Mark Testing
- 200 Volts per meter
- NARTE certified EMI engineers
- Full service engineering support
- FULL VEHICLE ANECHOIC CHAMBER
- DOC, FDA, FCC, RTCA, MIL-STD, SAE testing

FC CE SAE MIL-STD A2LA
RADIOMETRICS
Midwest Corporation
(815) 293-0772 www.radiomet.com

© 2008 Radiometrics Midwest Corp.

this case, though, the oxidation/rust in the connection had shown up as Christmas radio music in the chamber. The roof was a mess. There was much rust in diverse places. We took pictures of the damage as shown in Figures 2(a) and 3(a). Engineers should always keep good records so they can pass on these lessons or at least so they have lots of cool stories to tell.

By loosening the nuts on the two affected waveguides on top of the chamber it was possible to clean out the corrosion using a wire brush. It took more than one attempt to get them clean. After the roof was cleaned and the nuts re-tightened, the signals were checked again. The FM radio noise in the chamber was worse than before. We requested bronze wool to establish a better electrical connection. Placing the wool between the nut and the chamber roof panel was the solution. One of the cleaned and repaired waveguides is shown in Figure 2(b). Corrosion was also present at one of the ceiling panel joints. Since we could not take the joint apart to clean underneath it, we decided to clean the panel next to the joint and place conductive tape to form a bridge between the joint and the panel as shown in Figure 3(b). The Christmas radio signal we saw on the EMI receiver disappeared! A new trace run on the chamber (see Figure 4) confirmed the absence of the Christmas radio noise and reinstated the chamber engineers' Christmas spirit.

CANDACE SURIANO is a graduate of GMI Engineering & Management Institute (BSME) and has graduate degrees from Purdue University (MSME, MSE) and the University of Dayton (Ph.D.). She is the author of numerous papers on electromagnetic compatibility and chaired an antennas and probes workshop at several IEEE EMC symposia. Her interests are in the areas of electromagnetic compatibility and electromagnetic modeling. Candace is a mom with interests in MOM.

JOHN SURIANO is a graduate of GMI Engineering & Management Institute (BSEE) and has graduate degrees from Purdue University (MSME, Ph.D.). He supervises an EMC laboratory for Nidec Motors and Actuators in Auburn Hills, Michigan. He has interests in electric motors and electromagnetic modeling.

Looking for more information on this topic? Search *Interference Technology's* archive of technical articles at www.interferencetechnology.com

INDIRECT LIGHTNING & VOLTAGE SPIKE TEST EQUIPMENT



NR.1 WORLDWIDE FOR:

- ✓ DO-160/ED-14 section 17 +22
- ✓ AIRBUS
- ✓ BOEING

Want to be a leader ?

EMC - PARTNER

www.emc-partner.com
sales@emc-partner.com

Fixing emission source
high solution to
6 GHz



www.langer-emv.com

CISPR 32: New International Standard on Electromagnetic Emissions from Multimedia Equipment

DAN HOOLIHAN

Hoolihan EMC Consulting
Lindstrom, Minnesota USA

In late 2011, The International Standards Commission's (IEC's) Special Committee on Electromagnetic Interference (CISPR) passed a Final Draft International Standard (FDIS) which had been under development for a number of years. The FDIS was actually developed by CISPR's Subcommittee I - Electromagnetic Compatibility of Information Technology Equipment, Multimedia Equipment and Receivers. The Standard is called "CISPR 32" and it is titled: *Electromagnetic Compatibility of Multimedia Equipment - Emission Requirements*. This article outlines the contents of the New Standard and describes some of its specific criteria.

OUTLINE OF THE STANDARD

The layout of the standard follows the normal paragraph/clause orientation of most International Standards. That is: Scope, Normative References, Classification of Equipment, Requirements, Measurements, Equipment Documentation, Applicability, Test Report, Compliance with this Publication, and Measurement Uncertainty.

SCOPE

CISPR 32 applies to Multimedia Equipment (MME) having a rated Alternating Current or Direct Current supply voltage not exceeding 600 Volts. The standard is

written for equipment that will be tested in an EMC Testing Laboratory.

It does contain the following two objectives:

1. To establish requirements which provide an adequate level of protection of the radio spectrum, allowing radio services to operate as intended in the frequency range 9 kHz to 400 GHz.

2. To specify procedures to ensure the reproducibility of measurements and the repeatability of results from one testing laboratory to another.

NORMATIVE REFERENCES

The Normative References mentioned in CISPR 32 include: CISPR 16-1-1: 2010, CISPR 16-1-2:2003, CISPR 16-1-4:2010, CISPR 16-2-1:2008, CISPR 16-2-3:2010, CISPR 16-4-2:2011, CISPR/TR 16-4-3:2004, IEC 60050-161:1990, IEC 61000-4-6:2008, ISO/IEC 17025:2005, IEEE 802.3, and ANSI C63.5:2006.

TERMS, DEFINITIONS AND ABBREVIATIONS

Some key definitions in the standard include:

3.1.6 - Audio Equipment - Equipment which has a primary function of either (or a combination of) generation, input, storage, play, retrieval, transmission, reception, amplification, processing, switching or control of audio signals

3.1.7 - Broadcast Receiver Equipment - Equipment containing a tuner that is intended for the reception of broadcast

Providing a complete family of EMC Testing solutions



TEM Cells
DC to 2000 MHz

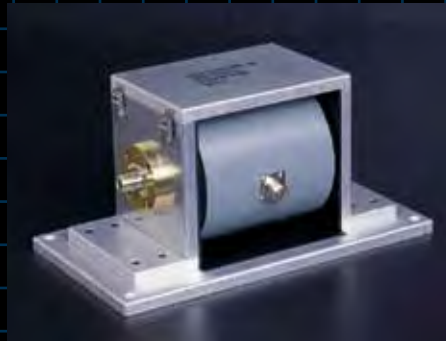

Injection Probes - Clamp-on,
CW and Pulse 10 KHz to 2000 MHz,
Internal Diameters from 32 to 66mm,
50 to 750 Watts



LISNs
10 KHz to 1 GHz, 5 to 350 Amperes



Monitor Current Probes
Surface & Clamp-on, 1 Hz to 5 GHz
Internal Diameters 5 mm to 1 meter



Coupling Decoupling Networks
150 KHz to 230 MHz / Power in 15 to 200
Amperes, Balanced line / Coaxial /
Shielded Multipin / Unshielded Multipin



Absorbing Clamp
30 to 1000 MHz



EM Injection Clamp
10 KHz to 1000 MHz



IEC 1000-4-8 Test Equipment



CISPR-22 Telecom Conducted Emission Test Accessories

Applications Mil-Std 461/462, CISPR, FCC, VDE, IEC 1000-4-6, -7, -8, -9, -10, ESD, HIRF, TREOP Bellcore, SAE J15447, RTCA DO-160



Fischer Custom Communications, Inc.

SERVING THE EMC COMMUNITY SINCE 1971

20603 Earl Street ■ Torrance, California 90503 USA ■ Telephone (310) 303-3300

Fax (310) 371-6268 ■ E-mail sales @fischercc.com ■ www.fischercc.com

services

3.1.15 - Entertainment Lighting Control Equipment - Equipment generating or processing electrical signals for controlling the intensity, color, nature or direction of the light from a luminaire, where the intention is to create artistic effects in theatrical, televisual or musical productions and visual presentations

3.1.20 - Information Technology Equipment (ITE) - Equipment having a primary function of either (or a combination of) entry, storage, display, retrieval, transmission, processing, switching, or control of data and/or telecommunication messages and which may be equipped with one or more ports typically for information transfer

3.1.29 - Video Equipment - Equipment which has a primary function of either (or a combination of) generation, input, storage, display, play, retrieval, transmission, reception, amplification, processing, switching, or control of video signals.

3.1.23 - MultiMedia Equipment (MME) - Equipment that is Audio Equipment, Broadcast Receiver Equipment, Entertainment Lighting Control Equipment, Information Technology Equipment, and Video Equipment

There are 67 abbreviations listed that are used in the Standard.

CLASSIFICATION OF EQUIPMENT

The standard defines two classes of equipment associated with two types of end-user environment.

Class B requirements are intended to offer adequate protection to broadcast services within the residential environment. Equipment intended primarily for use in a residential environment shall meet the Class B limits.

Note that all Broadcast receiver equipment is considered to be Class B equipment.

Class A requirements are for all non-Class B equipment; Class A equipment shall comply with the more relaxed Class A limits.

REQUIREMENTS

The requirements are covered in Annex A of the standard.

MEASUREMENTS

This part of the standard defines the measurement facilities and measurement instrumentation specific to the investigation of electromagnetic emissions from MultiMedia Equipment. The philosophy of the standard is that, unless otherwise specified, the basic international standards (for example, the CISPR 16 series of documents) shall be used for all measurement details.

The procedures to be used for measurement of emissions include: (1) the type of Equipment Under Test (EUT), (2) the type of port, (3) the types of cables used, (4) the frequency range, and (5) the mode of operation. Where a port is specified for use with both shielded and unshielded cables, the port shall be tested with both cable types.

The difference between two types of systems is covered in this clause. EUTs are either (1) a host system or (2) a modular system.

When the EUT is a host, it will be configured with modules so that the resulting system is representative of typical use.

When the EUT is a modular system; it can be comprised of different types of modules; (1) External (infra-red remote control), (2) Internal (computer hard-disk), (3) Plug-In (memory stick), and (4) Mounted (sound or video card). Modules intended to be marketed and/or sold separately from a host shall be assessed with at least ONE representative host system. The ports of any module tested shall be terminated in accordance with Annex D of the standard.

Measurements shall be performed using appropriate tables, annexes, and guidelines from the Standard. Prescan measurements shall be used to determine the cable arrangement giving the maximum emission level.

EQUIPMENT DOCUMENTATION

The standard requires that documentation shall contain details of any special measures required to be taken by the user of the EUT to assure compliance with the standard requirements.

Highest internal frequency (F_x)	Highest measured frequency
$F_x \leq 108$ MHz	1 GHz
108 MHz $< F_x \leq 500$ MHz	2 GHz
500 MHz $< F_x \leq 1$ GHz	5 GHz
$F_x > 1$ GHz	$5 \times F_x$ up to a maximum of 6 GHz

NOTE 1 For FM and TV broadcast receivers, F_x is determined from the highest frequency generated or used excluding the local oscillator and tuned frequencies.

NOTE 2 F_x is defined in 3.1.19.

Table 1. Required highest frequency for radiated measurements in the standard is shown.

Class A equipment must have the following warning statement in the user instructions:

WARNING: This equipment is compliant with Class A of CISPR 32. In a residential environment, this equipment may cause radio interference.

APPLICABILITY

If a manufacturer determines, from the electrical characteristics and intended usage of the EUT, that one or more measurements are unnecessary; the decision and justification for the decision shall be recorded in the test report.

TEST REPORT

The requirements for a test report that documents the results of testing to CISPR 32 are consistent with Clause 5.10 of ISO/IEC 17025. Reproducibility of the measurements is a key element of the test report and, where appropriate, photographs of the measurement configuration shall be included in the report.

The test report shall state: (1) the mode of operation, (2) how the EUT's ports were exercised (using Annex B as a guide), and (3) the product compliance status relative to Class A or Class B limits.

The measurement results of at least the six highest emissions from the type of port being assessed relative to the limit shall be recorded in the report unless they are 10 dB or more below the limit. The results shall include the following information for each emission: (1) the port

assessed, (2) for AC power line measurements, the line under test, (3) frequency and amplitude of the emission, (4) margin with respect to the specified limit, (5) the limit at the frequency of the emission, and (6) the detector used.

Additional information that shall be included in the report includes:

(1) the frequency of the highest internal frequency source unless radiated emissions are measured up to 6 GHz

(2) the calculated instrumentation measurement uncertainty for each measurement type unless U_{CISPR} is not defined for the relevant measurement type

(3) the category of the cable simulated by the Asymmetric Artificial Network (AAN), where emissions from wired network ports are measured using an AAN

(4) the measurement distance for radiated emission measurements as defined in appropriate tables in the standard. If a non-standard measurement distance is used, the report shall include a description of how the limits were calculated.

COMPLIANCE WITH THIS PUBLICATION

Compliance with CISPR 32 requires that the EUT has emissions either below Class A (more relaxed) limits or Class B (more stringent) limits. An Equipment Under Test that satisfies the requirements in Annex A of the standard is determined to fulfill the requirements in the entire frequency range from 9 kHz to 400 GHz.

Table clause	Frequency range MHz	Measurement		Class A limits dB(μV/m)
		Distance m	Detector type/ bandwidth	OATS/SAC (see Table A.1)
A2.1	30 – 230	10	Quasi Peak / 120 kHz	40
	230 – 1 000			47
A2.2	30 – 230	3		50
	230 – 1 000			57

NOTE Apply only A2.1 or A2.2 across the entire frequency range.

Table A.2. Requirements for radiated emissions at frequencies up to 1GHz for Class A equipment.

Table clause	Frequency range MHz	Measurement		Class A limits dB(μV/m)
		Distance m	Detector type/ bandwidth	FSOATS (see Table A.1)
A3.1	1 000 – 3 000	3	Average / 1 MHz	56
	3 000 – 6 000			60
A3.2	1 000 – 3 000		Peak / 1 MHz	76
	3 000 – 6 000			80

NOTE Apply A3.1 and A3.2 across the frequency range from 1 000 MHz to the highest required frequency of measurement derived from Table 1.

Table A.3. Requirements for radiated emissions at frequencies above 1GHz for Class A equipment.

Where CISPR 32 gives options for testing particular requirements with a choice of test methods, compliance can be shown by applying any one of the test methods using the appropriate limit.

Determination of compliance with CISPR 32 shall be based solely on contributions from the Equipment Under Test. Also, compliance can be shown by measuring the EUT's emission when operating its functions simultaneously, individually in turn, or any combination thereof.

MEASUREMENT UNCERTAINTY

Calculation of the measurement instrumentation uncertainty is done in accordance with CISPR 16-4-2:2011 - *Specification for radio disturbance and immunity measuring apparatus and methods - Part 4-2: Uncertainties, Statistics and Limit Modeling - Measurement Instrumentation Uncertainty*.

However, measurement uncertainty shall not be taken into account in the determination of compliance.

ANNEX A - REQUIREMENTS (NORMATIVE)

The requirements for equipment covered under CISPR 32 are given in Tables A.1 through A.12 in Annex A of the newest CISPR document.

Compliance with the radiated emission requirements may only be proven at measurement distances for which

compliant-facility or site-validation results exist for the measurement location being used for the radiated emission test.

The requirements for Class A equipment are shown in Tables A.2 and A.3 from the standard, as shown below. Note that Class A equipment may be measured at a 3 or 10-meter horizontal measurement distance at frequencies below 1 GHz.

The requirements for Class B equipment are shown in Tables A.3 and A.5 from CISPR 32.

The requirements for Class B equipment for conducted emissions on the Alternating Current power lines are shown in Table A.9, as below, and graphically displayed in the amplitude versus frequency plot following the Table.

ANNEX B - EXERCISING THE EUT DURING MEASUREMENT AND TEST SIGNAL SPECIFICATIONS (NORMATIVE)

This Annex of the CISPR 32 standard specifies the methods for exercising the EUT during the emission measurements. The EUT shall be operated in the selected mode(s) while the ports are exercised in accordance with this annex.

Clause B.2 is one of the more controversial parts of the standard since the standard (as specified in Table B.1) will require labs to test the video displays with both (1) standard TV color bar signals and (2) scrolling H characters. This will double the length of the test.

Table clause	Frequency range MHz	Measurement		Class B limits dB(µV/m)
		Distance m	Detector type/ bandwidth	OATS/SAC (see Table A.1)
A4.1	30 – 230	10	Quasi Peak / 120 kHz	30
	230 – 1 000			37
A4.2	30 – 230	3		40
	230 – 1 000			47

NOTE Apply only table clause A4.1 or A4.2 across the entire frequency range.

Table A.4. Requirements for radiated emissions at frequencies up to 1GHz for Class B equipment.

Table clause	Frequency range MHz	Measurement		Class B limits dB(µV/m)
		Distance m	Detector type/ bandwidth	FSOATS (see Table A.1)
A5.1	1 000 – 3 000	3	Average/ 1 MHz	50
	3 000 – 6 000			54
A5.2	1 000 – 3 000		Peak/ 1 MHz	70
	3 000 – 6 000			74

NOTE Apply A5.1 and A5.2 across the frequency range from 1 000 MHz to the highest required frequency of measurement derived from Table 1.

Table A.5. Requirements for radiated emissions at frequencies above 1GHz for Class B equipment.

Applicable to				
1. AC mains power ports (3.1.1)				
Table clause	Frequency range MHz	Coupling device (see Table A.7)	Detector type / bandwidth	Class B limits dB(μV)
A9.1	0,15 – 0,5	AMN	Quasi Peak / 9 kHz	66 – 56
	0,5 – 5			56
	5 – 30			60
A9.2	0,15 – 0,5	AMN	Average / 9 kHz	56 – 46
	0,5 – 5			46
	5 – 30			50

NOTE Apply A9.1 and A9.2 across the entire frequency range.

Table A.9. Requirements for conducted emissions from the AC mains power ports of Class B equipment.

ANNEX C - MEASUREMENT PROCEDURES, INSTRUMENTATION, AND SUPPORTING INFORMATION - NORMATIVE

This Annex provides additional information, measurement procedure, and requirements to supplement the normative references defined in Annex A.

- Annex C is divided into 3 main clauses:
 - (1) Instrumentation and supporting information
 - (2) General measurement procedures
 - (3) MME-related measurement procedures

ANNEX D - ARRANGEMENT OF EUT, LOCAL ASSOCIATED EQUIPMENT, AND ASSOCIATED CABLING - NORMATIVE

This Annex in CISPR 32 contains a Table D.1 which covers spacing and distances with associated tolerances for a variety of elements for both conducted and radiated emissions.

ANNEX E - PRESCAN MEASUREMENTS - PRESCAN MEASUREMENTS - INFORMATIVE

The purposes of a prescan are to determine the frequencies at which an EUT produces the highest level of emissions,

and to help select the configurations to be used in the formal measurements. Prescan measurements may be performed with spectrum analyzers without pre-selection provided that precautions are used to ensure that the instrument is not overloaded.

ANNEX F - TEST REPORT CONTENTS SUMMARY - INFORMATIVE

Guidance for compiling a test report can be found in ISO/IEC 17025:2005 - General Requirements for the Competence of Testing and Calibration Laboratories. The appropriate clause in 17025 is 5.10 - Reporting the Results. Table F.1 in CISPR 32 summarizes the information to be included in the test report for a CISPR 32 test.

ANNEX G - SUPPORT INFORMATION FOR THE MEASUREMENT PROCEDURES DEFINED IN C.4.1.1 - INFORMATIVE

Annex G has a series of schematic diagrams to assist measurement procedures defined in Annex C of the standard. It includes diagrams for asymmetric artificial networks with various screened and unscreened pairs of wires.

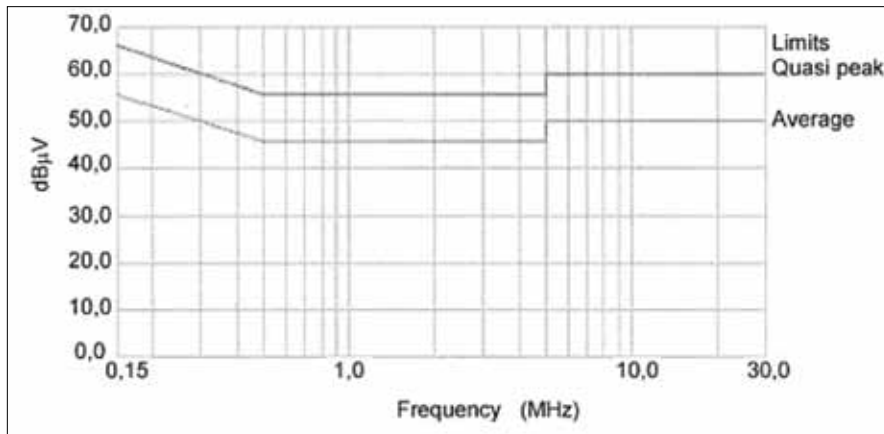

Figure A.1. Graphical representation of the limits for the AC mains power port defined in Table A.9.

BIBLIOGRAPHY

The new CISPR 32 standard concludes with an extensive Bibliography of standards and other associated documents.

DANIEL HOOLIHAN is a past president of the IEEE EMC Society. He has been a member of the Board of Directors since 1987 and has held numerous leadership positions in the society. Hoolihan is also active on the ANSI Accredited Standards Committee on EMC, C63 as Chairman. He was co-founder of Amador Corporation (1984-1995). He can be reached at DanHoolihanEMC@aol.com.

ANTENNAS

Products & Services Index

INTERFERENCE TECHNOLOGY'S 2012 Antennas Products & Services Index contains 11 different categories to help you find the antennas you need. Full details of all the suppliers listed within each category can be found in the Company Directory, starting on page 151. The EMC Products & Services Index is presented in its entirety, starting on page 142.

ANTENNA FILTERS

Captor Corp.
Fotofab
Spectrum Advanced Specialty Products

ANTENNA MASTS

ETS-Lindgren

ANTENNAS

A.H. Systems, Inc.
Advanced Test Equipment Rentals
Applied Electromagnetic Technology LLC
AR RF/Microwave Instrumentation
ARA Technologies
Beehive Electronics
Com-Power Corp.
Dynamic Sciences International, Inc.
Electro-Metrics Corp.
ETS-Lindgren
Fotofab
Instruments for Industry (IFI)
Laird Technologies
Liberty Labs, Inc.
Lubrizol Conductive Polymers
Noise Laboratory Co., Ltd.
Q-par Angus Ltd.

Spectrum Advanced Specialty Products
Sunol Sciences Corp.
TDK Corp.
TDK RF Solutions
Teseq

BICONICAL ANTENNAS

A.H. Systems, Inc.
ETS-Lindgren
Instruments for Industry (IFI)
Liberty Labs, Inc.
Noise Laboratory Co., Ltd.
Teseq

E-FIELD ANTENNAS

A.H. Systems, Inc.
Advanced Test Equipment Rentals
AR RF/Microwave Instrumentation
ETS-Lindgren
Instruments for Industry (IFI)
Noise Laboratory Co., Ltd.

EMI TEST ANTENNAS

A.H. Systems, Inc.
Advanced Test Equipment Rentals
AR RF/Microwave Instrumentation
ETS-Lindgren
Fotofab
Instruments for Industry (IFI)

Laird Technologies
TDK RF Solutions

H-FIELD ANTENNAS

A.H. Systems, Inc.
AR RF/Microwave Instrumentation
ETS-Lindgren
Instruments for Industry (IFI)
Noise Laboratory Co., Ltd.

HORN ANTENNAS

A.H. Systems, Inc.
Advanced Test Equipment Rentals
AR RF/Microwave Instrumentation
ETS-Lindgren
Instruments for Industry (IFI)
Liberty Labs, Inc.
Teseq

LOG PERIODIC ANTENNAS

A.H. Systems, Inc.

Advanced Test Equipment Rentals
AR RF/Microwave Instrumentation
ETS-Lindgren
Instruments for Industry (IFI)
Liberty Labs, Inc.
Noise Laboratory Co., Ltd.

MONOPOLE ANTENNAS

ETS-Lindgren
Instruments for Industry (IFI)
Liberty Labs, Inc.
Noise Laboratory Co., Ltd.

TEST ANTENNAS

Advanced Test Equipment Rentals
A.H. Systems, Inc.
AR RF/Microwave Instrumentation
Electro-Metrics Corp.
Instruments for Industry (IFI)
Teseq

LOOKING FOR ANTENNAS? You've found one great source of information. On InterferenceTechnology.com, search the EMC Buyers' Guide for an extensive list of manufacturers and distributors. See for yourself.

AMPLIFIERS

INTERFERENCE TECHNOLOGY'S 2012 Amplifiers Products & Services Index contains seven categories to help you find the amplifiers you need. Full details of all the suppliers listed within each category can be found in the Company Directory, starting on page 151.

Update, add or edit your company's information in *Interference Technology's* new interactive, electronic EMC Buyers' Guide. Then tell us what you think about the new tool by emailing Sarah Long at slong@item-media.net

AMPLIFIERS

Advanced Test Equipment Rentals
AE Techron, Inc.
Amber Technologies
Applied Systems Engineering, Inc.
AR Receiver Systems
AR RF/Microwave Instrumentation
CAP Wireless
Comtech PST Corp.
CPI (Communications & Power Industries)
dB Control
Instruments for Industry (IFI)
MCL, Inc., A MITEQ Company
MILMEGA Ltd.
Noise Laboratory Co., Ltd.
NP Technologies, Inc.
Ophir RF
Pasternack Enterprises
Power Products International Ltd.

Quarterwave Corporation
Silicon Labs
Teseq

AUDIO BAND POWER AMPLIFIERS

AE Techron, Inc.

MICROWAVE POWER AMPLIFIERS

Advanced Test Equipment Rentals
AR RF/Microwave Instrumentation
Giga-tronics/Ascor Inc.
Instruments for Industry (IFI)

RF POWER AMPLIFIERS

Advanced Test Equipment Rentals
AR RF/Microwave Instrumentation
Instruments for Industry (IFI)
Noise Laboratory Co., Ltd.

Teseq

SILICON CARBIDE UHF AMPLIFIERS

MILMEGA

SOLID STATE AMPLIFIERS

AE Techron, Inc.
AR RF/Microwave Instrumentation
Instruments for Industry (IFI)

TRAVELING WAVE TUBE (TWT) AMPLIFIERS

Applied Systems Engineering, Inc.
AR RF/Microwave Instrumentation
CPI (Communications & Power Industries)
Instruments for Industry (IFI)
Quarterwave Corporation
TMD Technologies Ltd.

Solve Your Systems Needs



Fully Integrated Test Systems Solutions For Any Application from DC to 50 GHz

Whether you choose one of our standard test systems – or have AR build a system to your specs – you'll be amazed at how easy, accurate, efficient, and affordable testing can be. Everything you need is right at your fingertips. It all works together perfectly, because everything has been carefully selected and assembled by AR engineers, using the most dependable and most innovative equipment on the market today.

Why An AR System Is The Smart Way To Test:

- No company has more experience and expertise in EMC test equipment than AR
- Reduced Test Time – get products to market faster
- Increased Accuracy
- Lower Risk
- Performance Guarantee – AR manufactures the majority of the system components allowing us to match and guarantee their performance
- Everything is fully tested before being shipped
- Single source for support & service
- More Compact & Portable – everything can be on one platform.

AR can deliver a solution that integrates all your testing needs: radiated immunity, conducted immunity, conducted emissions, radiated emissions, electrostatic discharge, lightning simulation ... whatever you need.

We have the expertise and experience to supply turn-key and fully automated systems needed to test various standards including IEC 61000, MIL-STD 461 and 464, DO-160, wireless, automotive, HIRF and HERO.

www.arworld.us/Systems

ISO 9001:2008
Certified

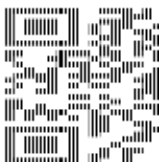

rf/microwave instrumentation

Other **ar** divisions: modular rf • receiver systems • ar europe

USA 215-723-8181. For an applications engineer, call 800-933-8181.

In Europe, call ar United Kingdom 441-908-282766 • ar France 33-1-47-91-75-30 • emv GmbH 89-614-1710 • ar Benelux 31-172-423-000

www.arworld.us

Antenna To Antenna Coupling On An Aircraft: Mitigation Techniques

DAVID A. WESTON

EMC Consulting, Inc.
Merrickville, Ontario, Canada

The number of RF systems available for use in mission specific aircraft has grown dramatically over the last few decades, with numerous systems operating across very wide bandwidths (some covering almost the entire 1MHz to 40GHz range).

Compatibility issues have become almost a certainty on all but the simplest of aircraft installations, and numerous mitigation techniques have been developed to address these issues. These compatibility issues include:

1. Passive Intermodulation (PIM) incident power on these structures.
2. IF interference, where the transmitter is at the receiver IF frequency.
3. Harmonic interference, where a harmonic of the transmitter is at the intended receive frequency.
4. Cross modulation interference, where a high level transmission close to the receiver frequency is not sufficiently attenuated by the receiver input filter (if any). Here compression, intermodulation and spurious responses can occur in the receiver.
5. Adjacent channel interference from a transmitter close enough to lie within either the receiver IF bandwidth or the receiver bandwidth.
6. Broadband noise from a transmitter which is in band for a receiver.

This paper explains some of the mitigation techniques that can be used to improve intersystem compatibility on an aircraft installation.

PRELIMINARY EMC PREVENTION

Improving intersystem compatibility begins at the initial design stage. When choosing on-board systems, careful consideration should be given to the transmit and receive frequencies of the desired equipment as well as the output power levels, sensitivity levels, blanking capabilities, and intended usage.

A table of all systems and relevant information should be prepared, and this table can be used to determine potential conflicts and the possibility of Simultaneous Operations (SIMOPS). It is important to consider intended usage as some conflicts are quite acceptable. For example the emergency locator transmitter (ELT) transmits in the same range as regular communication radios, however the ELT will only be used in the case of a downed aircraft, and under those circumstances many of the other systems will not be required to operate.

For systems that are required to operate in the same or similar bandwidths, the primary preventative measure is antenna placement. Conflicting system antennas can be mounted at opposite ends of the aircraft or in some cases at the top and bottom of the aircraft. This reduction in coupling increases the isolation between the antennas. The coupling around an

CPI: Powering your world.



Meet the new automotive and military EMC standards with CPI high-powered TWT amplifiers.

EMC facilities worldwide depend on CPI amplifiers for superior performance, reliability, and quality. CPI has a proven track record of consistent performance, service, and support. For EMC testing, CPI is the only manufacturer of both the TWT and the amplifier, ensuring quality designs and smooth operation. CW and pulsed amplifiers are available from 1 to 95 GHz, with power levels exceeding 2 kW over selected frequencies.

TWTAs for EMC applications

1.0 -18.0 GHz up to 1000 W CW (10 kW available over select bands)

18.0-40.0 GHz up to 150 W (2.0 kW over select bands)

40.0 – 50.0 GHz up to 80 W

Full Pulsed Amplifier Suites to 8 kW
(megawatts pulsed power capability)

For more information please contact:

Communications & Power Industries Canada, Inc.
45 River Drive, Georgetown, Ontario, Canada L7G 2J4

For Sales offices worldwide please e-mail: marketing@cmp.cpii.com

Or look us up on the Web at: www.cpii.com/emc



satcom division

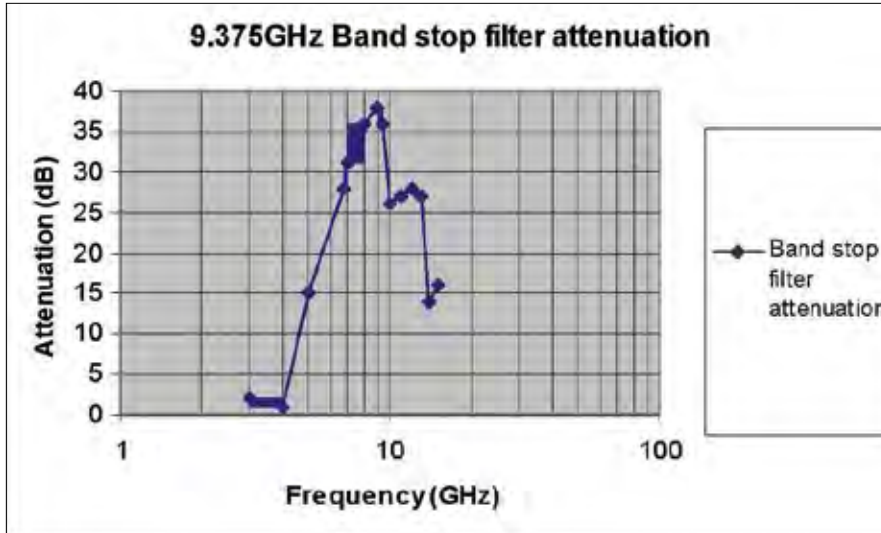

Figure 1. Band stop filter centered at 9.375 GHz.

aircraft is typically a composite of reflections from the Wings and Engine Nacelle as well as the coupling due to the creeping wave around the fuselage. Various techniques, including measurement and computer modeling, are available to determine the coupling between antennas mounted at various locations around an aircraft. These techniques are described in more detail in references 1

and 2 and in practical terms allows an EMC engineer to decide if it is worthwhile to re-position two co-located antennas to the top and bottom of a fuselage or wing or increase the distance between them.

Effective reduction in coupling may be achieved for horizontally polarized transmitting antennas which operate over a narrow frequency range and which couple to either a vertically or horizontally polarized receiving antennas in close proximity. The location of the two antennas may be chosen so that the direct wave and the wave reflected from the surface of the aircraft tend to cancel. This cancellation may be more effective than locating antennas on opposite

sides of the fuselage at low frequency. Many pieces of equipment also include blanking capabilities. For example, a transmitter may provide a DC output signal when transmitting, and this DC output can be used to disconnect receiving signal paths of local sensitive equipment. Similarly some equipment includes blanking input connections which disconnect the received

RF signal when a DC level is present at the blanking input.

ABSORBER

Absorber can also be placed on surfaces, such as the wings, engine, vertical stabilizer and tail plane to reduce reflection as well as for damping surface waves. The absorber may be flexible silicone rubber lossy sheet which is weather proof and can be glued to surfaces.

These are typically effective at microwave frequencies, such as used by radar, with some frequency tuned and others effective over a broad band of frequencies. Also a thin ceramic ferrite absorber is available effective from 10MHz to 1GHz. One manufacturer is Cuming Corporation.

FILTERS

The use of low pass, band pass and band stop filters at the input of receivers can be effective at reducing compression, generation of spurious response, and desensitization of the receiver. High power filters are commercially available for use at the output of transmitters and these are

RENT EMC GEAR



IEC61000 · MIL461
DO160 · ISO7637
EFT, Surge, Ringwave, PQF
200 v/m RS 10kHz-40GHz
Lightning Strike



Complete Immunity Test Systems
TWT Amplifiers · Antennas
CDNs · RF Probes · ESD Guns
EMI Receivers · LISNs · Clamps



Teseq · Haefely · Keytek · Narda
Solar · IFI · Amplifier Research
HV Technologies · FCC · NoiseKen
ETS-Lindgren · Rohde & Schwarz
Com-Power · Agilent · and more!

Call a Rental Agent today at
888-544-ATEC (2832)
or visit us on the web at
www.atecorp.com/ITEM



Advanced Test Equipment Rentals

The Knowledge. The Equipment. The Solution.

FOLLOW US







ARE YOU
RECEIVING
ELECTRONICS
COOLING
ENEWS?

Electronics **COOLING**

Electronics Cooling eNews delivers the latest thermal management
news | product updates | events | and more

Subscribe online today | electronics-cooling.com

ITEM
MEDIA



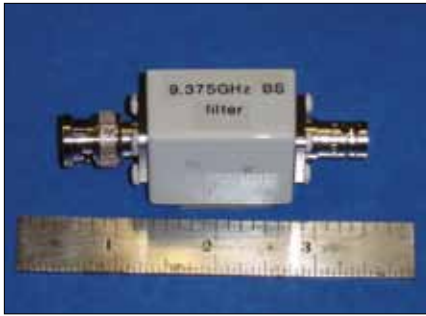

Figure 2. The enclosure used for band stop, band pass, low pass filters and the limiter.

used to reduce harmonics and broad band noise from the transmitter.

For transceivers it is possible to design an input filter which can transmit the output power safely and without excessive attenuation.

As an example a weather radar transceiver or a SLAR system operating at 9.375 GHz may cause interference to adjacent receivers, and these receivers can be protected using a band stop filter centered at 9.375 GHz. The insertion loss for this fil-

Upper band pass frequency (MHz)	Attenuation at upper band pass frequency	Out of band frequency (MHz) and Attenuation (dB)	1030MHz Out of band frequency Attenuation (dB)
2	1.2	100MHz 90dB	1030MHz 38dB
30	1.5	100MHz 45dB	1030MHz 55dB
200	1.5	500MHz 50dB	1030MHz 45dB
406	1.5	800MHz 50dB	1030MHz 38dB

Table 1. Performance of typical low pass filters.

ter is negligible at frequencies below 2GHz. The attenuation characteristics of this filter is shown in figure 1. EMC Consulting have designed, built a band stop filter tunable from 700MHz to 1.1GHz with 30dB of attenuation at the center frequency. With the center frequency of this filter adjusted to 1GHz the insertion loss for the filter is less than 0.5dB up to 300MHz and 2dB up to 400MHz. All of the filters described in this report will fit into the small enclosure shown in figure 2 and have been constructed and tested with either BNC

or TNC connectors. This size is ideal for connecting directly at the input of the receiver.

Low or high pass filters can be used where one transmitter frequency comes close to, but does not overlap a receiver. For example a receiver operating in the 1 to 30MHz range would benefit from a low pass filter which attenuates above 30MHz when used in close proximity to a transmitter operating in the 30 MHz to 88MHz range.

Low pass filters are also effective when the interfering signal is at a significantly higher frequency than the in band receiver frequencies. The performance of a range of these filters is shown in table 1 and for the 200MHz in the plot of figure 3.

Filters with sharper roll off above the upper frequency are available commercially but are typically larger than the enclosure seen in figure 2.

LIMITER

Limiters can be used in conjunction with other mitigation techniques or alone. If a high level signal is being received at the input to a receiver either in band or out of band a limiter can be used to reduce the input level to an acceptable level without interfering with the desired received signal, unless the two are tuned to exactly the same frequency.

For example, a receiver which is sensitive to -50 dBm but which compresses when an out of band signal exceeding 0 dBm is applied may compress when placed in close proximity to a high power transmitter. The introduction of a 0 dBm limiter would reduce the high power received levels to a manageable level while allowing the intentional

WIDE-BAND CURRENT PROBES

Accurately measure EMI, surge, lightning, and other complex wave shapes with a Pearson Current Probe.

- 8x20 and 10x350 μ sec surge currents
- Peak currents up to 500 kilo amperes
- 6 decade flat transfer impedance, 10 Hz to 10 MHz.
- Frequencies up to 200 MHz
- Minimum current 10 μ A (20 dB μ A)

Since 1955, Pearson Electronics has manufactured and stocked a wide selection of current probes.

Browse our website for specifications and application notes or call for help selecting the right current probe.

pearsonelectronics.com
PHONE: +1 (650) 494-6444

Pearson
ELECTRONICS

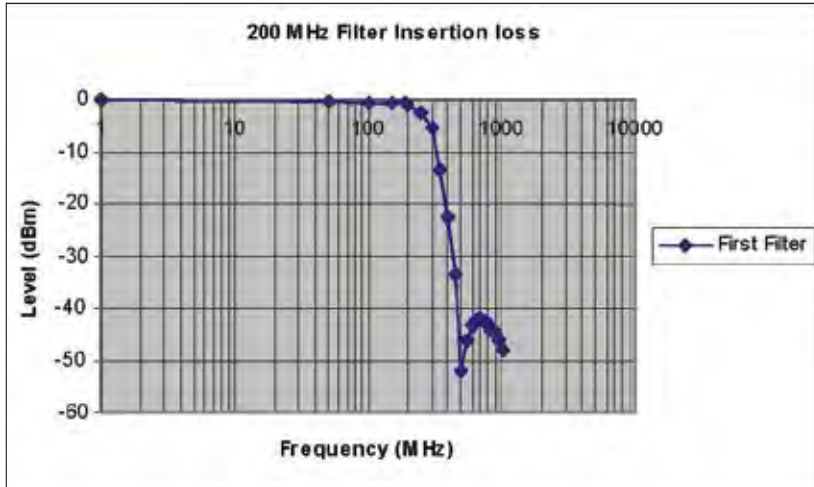

Figure 3. Insertion loss of 200MHz low pass filter.

received levels to pass without compression. The insertion loss for a typical limiter is -2dB from 50 – 500MHz with a useful frequency range of 5 to 3000MHz. EMC consulting has manufactured a PCB on which the limiter was mounted and placed in the enclosure shown in figure 2. The input voltage is 28V and the limiter is protected against all of the EMC power line conducted susceptibility and power characteristics specified in DO-160 or MILSTD-461 by additional components mounted on the

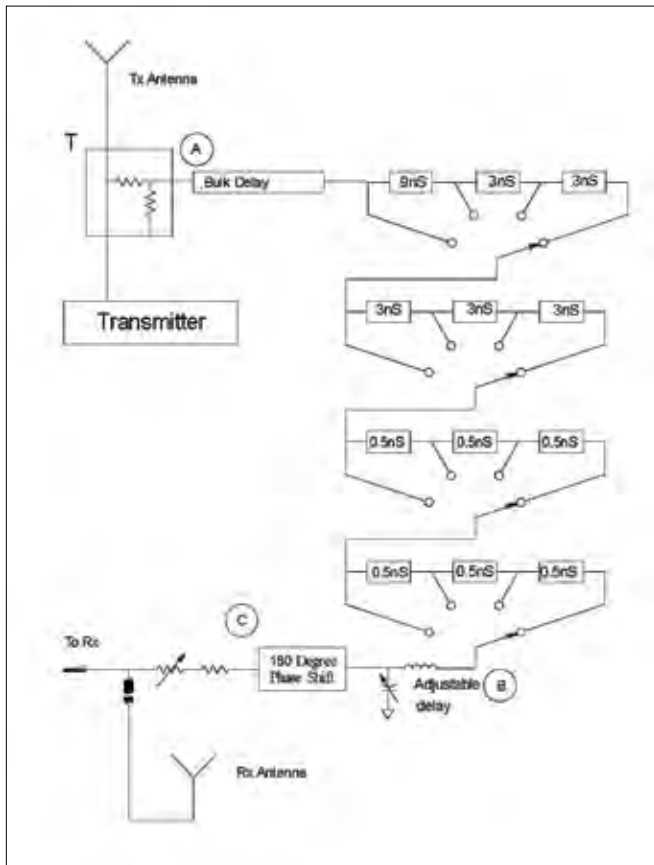

Figure 4. Delay, phase shift, and summation circuit block diagram.

PCB. The operating temperature range of the limiter and associated components is -54°C to 85°C.

RF SWITCH AND BLANKING

When transmitters have blanking outputs and receivers blanking inputs then these may be connected to blank the receiver when the transmitter is operational. Some additional components may be required to make the control signal levels compatible. Also when the RF output of the transmitter remains powered up broadband noise is still transmitted. If the transmitter has a blanking output but a receiver does not have a blanking input an RF switch may be used at the receiver input. One such switch is the Mini-circuits ZFSWA-2- 46 which

can be used from DC-4.6GHz. It has maximum 0.8dB attenuation from DC-200MHz, 1.3dB up to 1GHz and 2.6dB from 1- 4.6GHz. It requires two signal inputs to switch from “off “ to “on”, -8V on one and 0V on the other or vice versa. It is possible to use a simple sine wave oscillator connected to the +28V power, transformer, rectifier and linear regulator to obtain the -8V and the circuit can be protected against all of the DO-160 or MIL-STD 461 power line conducted susceptibility test levels. The maximum input level for this switch is +24dBm and the video leakage (the control level feedthrough conducted out of the RF output) is 30mV pk-pk.

DELAY AND PHASE SHIFT CANCELLATION

The concept of in band cancellation is introduced in section 10.2.2.2 of reference 3. When the transmit and receive frequency bands overlap then filters are clearly not applicable.

When the interferer received level is extremely high and may result in damage to the receiver the limiter may be used. However even with the limiter in circuit the level after limiting may be high enough to result in receiver de-sensitization, cross modulation or spurious generation.

To cancel or reduce the interferer level a propagation delay, 180 degree phase shift and summation circuit has been developed. This is shown in the block diagram figure 4. The output of the transmitter is tapped off with no reduction in power level between the transmitter and antenna. This can be achieved anywhere on the transmit cable from the transmitter end to the transmit antenna end. The ideal location depends on the total propagation delay of the transmit cable, the coupling path in air between the antennas and the receiver cable, as described later.

The output of the transmitter is attenuated and matched to the impedance of the cable which connects to the circuit at point A. The interferer signal is then passed through a bulk delay. The bulk delay can be in the tens of microseconds the only limit is the attenuation inherent in

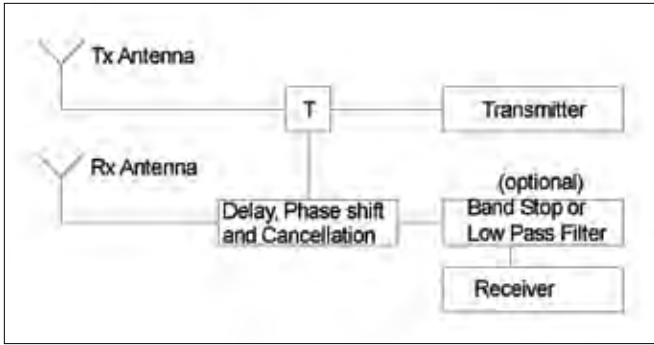

Figure 5. Delay, phase shift, and summation circuit with filter.

the delay elements and the physical size of the enclosure. In practice delays up to 500nS are adequate. For the final selection of the total delay thin film delay lines can be connected in or out of circuit and a fine tuning performed with a variable capacitor and an inductor. With 0.5nS, and 3nS thin film delay circuits the selectable delay can be from 0.5nS to 18nS in 0.5nS increments and the tuned delay can be adjusted over 0.5nS. The total transmitter to circuit cable delay, bulk, and variable delays are chosen to be exactly equal to the transmitter to receiver total path propagation delay. This means that the input signal to the circuit from the receiving antenna and the signal at location B in the circuit are in phase. The signal at point

B then undergoes a 180 phase shift which is virtually frequency independent.

The signal at point C is then adjusted in level and summed with the receiver input signal.

This achieves an almost complete cancellation at a specific frequency. At either side of this frequency the amplitude at the output of the delay circuit is different from the receiving antenna level. This is because the attenuation with frequency of the transmitter to receiver path is different from the phase shifter cancellation circuit. As the intentional signal from the receiving antenna is routed through the circuit the attenuation of the signal is 1.8dB. Figure 5 shows the path between transmitter and receiver. An input filter is shown in figure 5 but is not necessary.

The transmit path propagation delay can be determined approximately by transmitting a pulse amplitude modulated RF from a signal generator, using the modulation pulse to trigger an oscilloscope, and measuring the delay. An external modulator or RF switch may be used if the generator does not allow pulse modulation. The fine tuning of the delays in the circuit can be accomplished by again using a pulse amplitude modulated signal and comparing the output of the circuit to the input of the receiver. The two channels of the scope used to measure the two signals must have no delay between them (chopped display may be required).

The circuit was adjusted and tested from 1MHz to 30MHz, with the maximum attenuation adjusted at 30MHz. The attenuation achieved is shown in table 2. With the circuit adjusted for 108MHz the attenuation from 60MHz to 108MHz is shown in table 3.

At a single frequency such as 152MHz the cancellation can result in an attenuation of 28dB.

The delay circuits within the phase shift and summation circuit have some temperature coefficient as does the permittivity of the transmit and receive cables and

Amplifier First Aid...

Evaluate, Upgrade or Repair - the service does not stop there!

All Makes And Models

- Logimetrics •
- Kalmus •

Just To Name A Few

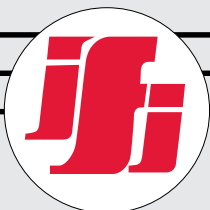

INSTRUMENTS FOR INDUSTRY INC.

903 South Second Street, Ronkonkoma, NY 11779

Tel: 631-467-8400 • Fax: 631-467-8558 • E mail: sales@ifi.com

www.ifi.com

At IFI we believe the service on any amplifier doesn't stop when it comes out of the box. Our service professionals have been repairing and upgrading all brands of Amplifiers for over 25 years. Call today for a free evaluation.

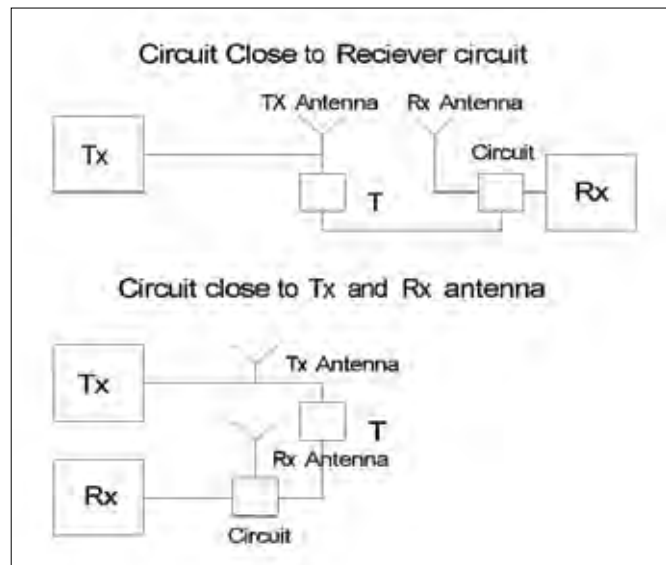

Figure 6. Delay, phase shift, and summation circuit configurations.

Frequency (MHz)	Attenuation of transmitter signal (dB)
1	19
2	19
5	20
10	35
15	26
20	33
25	35
30	>48

Table 2. Cancellation attenuation 1MHz to 30 MHz.

Frequency (MHz)	Attenuation of transmitter signal (dB)
60	26
70	26
80	33
90	26
100	35
108	49

Table 3. Cancellation attenuation from 60MHz to 108 MHz.

this changes the delay. However the measured change in attenuation of the delay and cancellation circuit was only 1.5dB from 4°C to 47°C.

The location of the T and the circuit depend on the location of the transmitter, receiver, transmit antenna and receive antenna. The goal would be to reduce the amount of cable delay and therefore the amount of bulk delay required in the circuit. Two possible configurations are shown in figure 6.

REFERENCES



- [1]. D. Weston. "Antenna to Antenna Coupling on an Aircraft Using a 1/10th Scale Model with Results Compared to the FEKO Electromagnetic Analysis Program," EMC Europe 2010, Wroclaw, Poland.
- [2]. D. Weston. "Comparison of Techniques for Prediction and Measurement of Antenna to Antenna Coupling on an Aircraft," EMC Europe 2011, York, England.
- [3]. D. Weston. "Electromagnetic Compatibility: Principles and Applications," Second Edition. 2001. Marcel Dekker Inc, New York.

DAVID A. WESTON is principle EMC engineer at EMC Consulting, Inc., Merrickville, Ontario, Canada. A member of IEEE and NARTE, Weston has worked full time in EMC for the last 30 years. He is author of the book, "Electromagnetic Compatibility: Principles and Applications" as well as numerous papers and reports, many of which are available at emcconsulting.com. He studied at Croydon Technical College from 1960 to 1965.

RF Amplifiers & Modules



Ophir RF has one of the largest arrays of high-power, solid state, broadband amplifiers in the industry. Our core products include RF amplifiers from 10kHz to 18GHz with power levels from 1W to 24 kW.

Military Applications • Scientific Labs • EMC Testing

RF Amplifier Systems

Model	Frequency	Power	Size (RU)
5085	0.01-250MHz	100W	5U
5087	0.01-200MHz	250W	5U
5088	0.01-200MHz	600W	8U
5225	80-1000MHz	200W	3U
5227	80-1000MHz	500W	5U
5228	80-1000MHz	1000W	11U
5135	800-2000MHz	300W	5U
5136	800-2000MHz	500W	5U
5163	800-4200MHz	50W	3U
5164	800-4200MHz	80W	5U
5165	800-4200MHz	250W	8U
5193	2000-6000MHz	50W	3U
5194	2000-6000MHz	100W	5U

RF Amplifier Modules

Model	Frequency	Power	Size (H x W x L)
5304024	100-1000MHz	200 W	1.5" x 3.0" x 12.0"
5304025	800-3000MHz	200 W	1.5" x 3.0" x 12.0"
5304043	2500-6000MHz	50 W	1.1" x 5.0" x 7.0"

Modules designed to meet:

Operating temperature up to +85C ; MIL-STD-810 for Shock, Vibration, Humidity, Salt Fog etc.

310. 306. 5556 www.ophirrf.com

FILTERS / FERRITES

Products & Services Index

INTERFERENCE TECHNOLOGY'S 2012 Filters / Ferrites Products & Services Index contains nearly 30 different categories to help you find the filters and ferrites you need. Full details of all the suppliers listed within each category can be found in the Company Directory, starting on page 151. The EMC Products & Services Index is presented in its entirety, starting on page 142.

ABSORPTIVE FILTERS

Dontech, Inc.
Instruments for Industry (IFI)
Intermark (USA) Inc.

ACTIVE FILTERS

LCR Electronics, Inc.
Schaffner EMC, Inc.

COAXIAL FILTER CONNECTORS

Captor Corp.
EMC Eupen, A Div. of I2R Corp.
Kensington Electronics Inc.
Soshin Electronics Europe GmbH
Spectrum Advanced Specialty
Products

DISCOIDAL CAPACITORS

Union Technology Corp.

FEED-THROUGH FILTERS

Captor Corp.
EMI Filter Company
Instec Filters
Radius Power, Inc.
RF Immunity Ltd.
Schaffner EMC, Inc.
Spectrum Advanced Specialty
Products
Syfer Technology Limited
TDK-EPC Corp.
Tri-Mag, Inc.

FERRITE BEADS & CORES

AEM, Inc.
Allied Components International
Cosmo Ferrites Limited
Fair-Rite Products Corp.
Ferronics, Inc.
Intermark (USA) Inc.
Kemtron Ltd.
Magnet Industry Ltd.
MEC Kitagawa
National Magnetics Group, Inc.
TDK-EPC Corp.
THORA Elektronik GmbH

FERRITE SUPPRESSION COMPONENTS

ARC Technologies, Inc.
Fair-Rite Products Corp.
Intermark (USA) Inc.
Kemtron Ltd.
Spectrum Advanced Specialty
Products

FERRITES

Adams Magnetic Products Co.

AEM, Inc.
Allied Components International
ARC Technologies, Inc.
Dexter Magnetic Technologies
EMC Component Group, Inc.
Fair-Rite Products Corp.
Intermark (USA) Inc.
Kemtron Ltd.
Magnet Industry Ltd.
MEC Kitagawa
Spectrum Advanced Specialty
Products
Taiyo Yuden (U.S.A.) Inc.

FILTER ARRAYS

Captor Corp.
Fotofab
Syfer Technology Limited
Spectrum Advanced Specialty
Products

FILTER CAPACITORS

AVX Corporation
Beijing Tempest Electronics
Technologies Co. Ltd.
Captor Corp.
EMI Filter Company
Fotofab
Instec Filters
LCR Electronics, Inc.
Radius Power, Inc.
Schaffner EMC, Inc.
Spectrum Advanced Specialty
Products
Syfer Technology Limited
Synergistic Technology Group,
Inc.
TDK-EPC Corp.
X2Y Attenuators LLC

FILTER CHOKES

Captor Corp.
Datatronics
Fair-Rite Products Corp.
LCR Electronics, Inc.
Radius Power, Inc.
Schaffner EMC, Inc.
Schurter Inc.

FILTER COILS

Captor Corp.
Communication Coil, Inc.
Curtis Industries / Filter
Networks
Radius Power, Inc.
Schaffner EMC, Inc.
Schurter Inc.

FILTER CONNECTORS

AEF Solutions

Captor Corp.
Curtis Industries / Filter
Networks
Glenair Inc.
Heiland Electronics
Kensington Electronics Inc.
Spectrum Advanced Specialty
Products
Spectrum Control
Schurter Inc.

FILTER MODULES

Captor Corp.
Curtis Industries / Filter
Networks
Elite EMC Ltd.
Instec Filters
Schaffner EMC, Inc.
Schurter Inc.
Spectrum Advanced Specialty
Products

FILTER PIN CONNECTORS

Captor Corp.
Fischer Connectors Inc.
Kensington Electronics Inc.
Spectrum Advanced Specialty
Products

FILTER PINS

EMI Filter Company
Instec Filters
Spectrum Advanced Specialty
Products
Syfer Technology Limited

FILTER SEAL INSERTS

Kensington Electronics Inc.
Lamart Corp.

FILTERED POWER ENTRY MODULES

Americor Electronics, Ltd.
Captor Corp.
Curtis Industries / Filter
Networks
Qualtek Electronics Corp.
Radius Power, Inc.
Schaffner EMC, Inc.
Schurter Inc.
Spectrum Advanced Specialty
Products
Tri-Mag, Inc.

FILTERS

Advanced Monolithic Ceramics,
Inc.
Aerodev Electronmagnetic Tech
Alco Technologies, Inc.
Amphenol Canada Corp.

API Delevan
Arcotronics, Inc.
Aries Electronics
AVX Corporation
Capcon International, Inc.
Captor Corp.
Cre8 Associates Ltd.
Curtis Industries / Filter
Networks
E3 Displays
EESeal
Electrocube, Inc.
Elite EMC Ltd.
EMI Filter Company
EMI Solutions Inc.
EPCOS, Inc.
ETS-Lindgren
Fil-coil
Filter Concepts, Inc.
Filtronica, Inc.
Fotofab
Fuss-EMV
Genisco Filter Corp.
Gowanda Electronics
High & Low Corporation
Instruments for Industry (IFI)
Integrated Microwave Corp.
Intermark (USA) Inc.
Jiangsu WEMC Technology Co.,
Ltd.
Johanson Dielectrics, Inc.
LCR Electronics, Inc.
Mercury United Electronics Inc.
MPE Limited
Murata Electronics North
America
Oxley Developments Company
Ltd.
Pacific Aerospace & Electronics,
Inc.
Panasonic Electronic
Components
Quell Corporation
Radius Power, Inc.
RFI Corp.
Roxburgh EMC
Sabritec
Schaffner EMC, Inc.
Schurter Inc.
SiTime Corp.
Souriau PA&E
Spectrum Advanced Specialty
Products
Spectrum Control
Suppression Devices
Syfer Technology Limited
Synergistic Technology Group,
Inc.
Texas Spectrum Electronics
Tyco Electronics

V Technical Textiles, Inc.
View Thru Technologies, Inc.
Vishay Intertechnology, Inc.
VPT, Inc.

INDUCTORS

BI Technologies
Captor Corp.
Curtis Industries / Filter Networks
Frontier Electronics, Corp.
Gowanda Electronics
Kensington Electronics Inc.
LCR Electronics, Inc.
Micrometals, Inc.
Schaffner EMC, Inc.
Schurter Inc.

MICROWAVE FILTERS

Cobham Microwave
EMI Filter Company
Fotofab
Instec Filters
Instruments for Industry (IFI)
LCR Electronics, Inc.
Spectrum Advanced Specialty Products
Syfer Technology Limited

POWER LINE FILTERS

Captor Corp.
Curtis Industries / Filter Networks

DNB Engineering, Inc.
Emission Control, Ltd.
Filter Concepts, Inc.
Genisco Filter Corp.
High & Low Corporation
Instec Filters
JINAN Filtemc Electronic Equipment Co., Ltd.
LCR Electronics, Inc.
MPE Limited
Radius Power, Inc.
Schaffner EMC, Inc.
Schurter Inc.
Syfer Technology Limited
TDK-EPC Corp.
Tri-Mag, Inc.

PRINTED CIRCUIT BOARD (PCB) FILTERS

Captor Corp.
Curtis Industries / Filter Networks
Radius Power, Inc.
Schurter Inc.
Spectrum Advanced Specialty Products
Syfer Technology Limited
Tri-Mag, Inc.

RETROFIT FILTERS & CONNECTORS

Quell Corporation

Schaffner EMC, Inc.
Schurter Inc.

SHIELDED ROOM FILTERS

Captor Corp.
Dontech, Inc.
ETS-Lindgren
Fotofab
TDK-EPC Corp.

SIGNAL LINE FILTERS

Captor Corp.
Curtis Industries / Filter Networks
EMI Filter Company
ETS-Lindgren
Instec Filters
Spectrum Advanced Specialty Products
Syfer Technology Limited
TDK-EPC Corp.
WEMS Electronics

SPREAD SPECTRUM PRODUCTS

Mercury United Electronics Inc.
SiTime Corp.

SUPPRESSORS

ARC Technologies, Inc.
Captor Corp.

Fair-Rite Products Corp.
Fischer Custom Communications
Kemtron Ltd.

TEMPEST FILTERS

Captor Corp.
Curtis Industries / Filter Networks
Dontech, Inc.
Syfer Technology Limited
Spectrum Advanced Specialty Products

WIRE & CABLE FILTERS

Captor Corp.
Spectrum Advanced Specialty Products

Filters have long played a key role in EMC testing and compliance. You've found one great source of information on InterferenceTechnology.com. See for yourself.



SCHAFFNER
energy efficiency and reliability

Reliability - for Comfort and Convenience

Schaffner EMC solutions - available from leading distributors worldwide

Schaffner EMC filters are instrumental for quick and simple qualification of electronic devices according to international requirements. They effectively control electromagnetic interference so the comfort of modern day electronics can be enjoyed at all times.

- Broadest off-the-shelf filter selection
- Reduced time to EMC compliance
- High level of integration with PCB mounting designs
- Chassis mounting designs for higher power devices
- Choice of filter performance and terminal style
- Dedicated medical versions available
- UL, CSA, and ENEC approvals for global application



www.schaffnerusa.com

Shortcomings of Simple EMC Filters

ANTONI JAN NALBORCZYK

MPE Ltd.
Liverpool, United Kingdom

Oversimplification of EMC filter selection to reduce size and cost can often be a false economy as anticipated performance may not be achieved.

INTRODUCTION

EMC design principles are best considered at the equipment design stage, where good mechanical design including component layout and cable routing can help reduce EMC problems at source. Even with good EMC practice, it is invariably necessary to provide a certain amount of filtering. Cost and size considerations will usually encourage the use of a simple filter design. This can sometimes be a false economy as simple designs may not always give expected results. This can have serious compliance implications if EMC specifications have to be met. Some of the commonly encountered problem areas and their solutions are discussed in this article.

PROBLEMS & SOLUTIONS

When using suppression capacitors either on their own or in filters, it is most important to keep lead lengths as short as possible. An ideal capacitor of capacitance value C would have a linear impedance characteristic Z expressed by $Z=1 / 2\pi fC$, where f is the measurement frequency.

However, a real two-terminal capacitor

will resonate at a frequency determined by its capacitance and the inductance L of its leads. The resonant frequency is given by $f=1 / 2\pi \sqrt{LC}$. Below the resonant frequency, the capacitor impedance follows the ideal response, but, above the resonant frequency, the capacitor suppression performance reduces dramatically. Increasing the lead length reduces the resonant frequency and causes a loss in performance of the capacitor.

This can be seen in Figure 1, which compares the impedance of a $1\mu\text{F}$ capacitor with 20mm and 100mm leads. The leads of a two-terminal capacitor will typically have an inductance of about 7nH per 10mm lead length, which gives a resonant frequency of about 800kHz for a $1\mu\text{F}$ capacitor with 20mm leads. The shaded area on the graph indicates the loss in performance caused by increasing the lead length from 20mm to 100mm.

Above its resonant frequency, the two-terminal capacitor behaves as an inductor with the inductance L of its lead wires. Its impedance then becomes $Z=2\pi fL$. If suppression performance is needed above the resonant frequency in line-to-earth applications, then a feedthrough capacitor must be used. Apart from a few minor resonances related to the dimensions of the capacitor element, the feedthrough capacitor has a performance close to the ideal.

Figure 2 shows the physical differences between two-terminal capacitors and feedthrough capacitors. Figure 3 compares

Superior Solutions: **EPCOS EMC Filters from TDK**

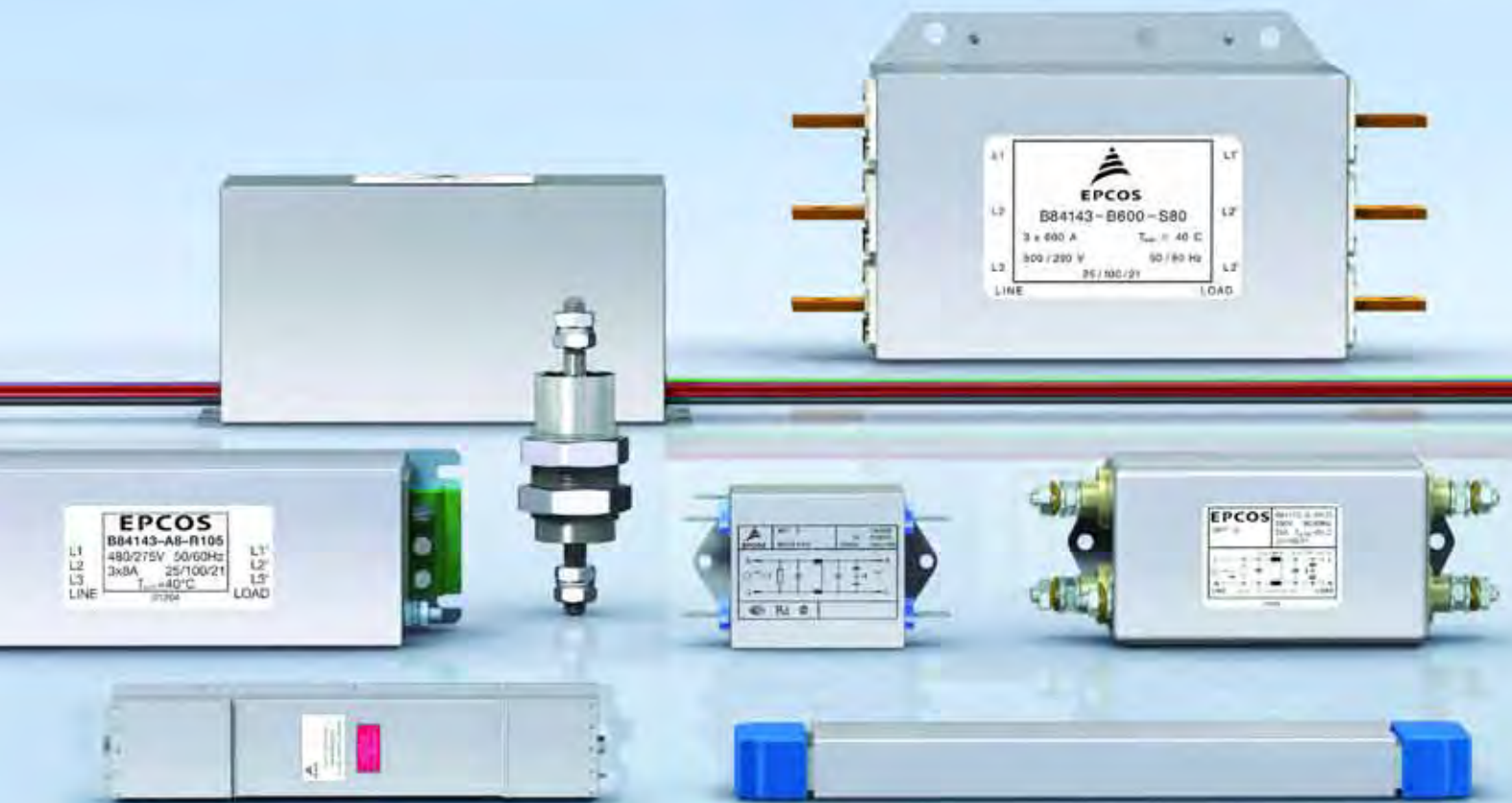

- Single- & multi-line EMC/RFI/EMI filters
< 1 Amp - 2500 Amps
- Custom and off-the-shelf solutions for every interference problem
- Global distribution and short lead times
- More than 50 years engineering experience
- USA and European EMC labs
- Shielded tempest and MRI room filters, including high-end 100 dB - 400 GHz models

For technical questions, call 516-658-1131

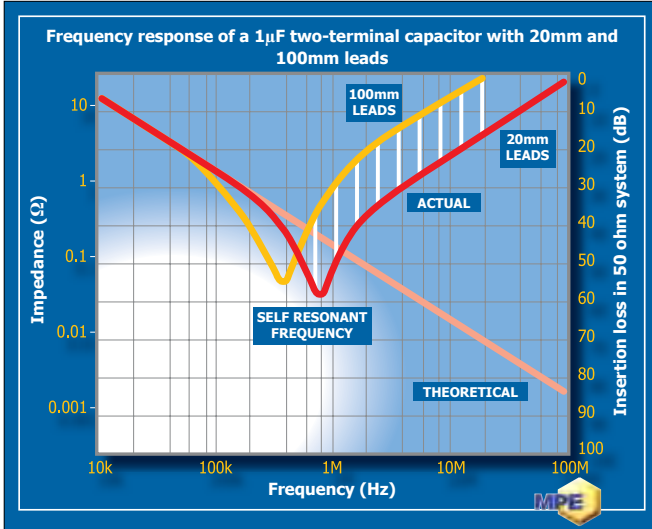

Figure 1. Frequency response of a 1µF two-terminal capacitor with 20mm and 100mm leads.

the performance of a 1µF feedthrough capacitor with a 1µF two-terminal capacitor. The shaded area shows the significant filtering performance not attainable from a two-terminal capacitor, which can be achieved by using a feedthrough capacitor of the same value.

For the same reason, good high-frequency performance



Figure 2. Typical feedthrough capacitors compared with two-terminal capacitors.

in filters can only be obtained if the filter incorporates feedthrough capacitors. As an example, Figure 4 shows the insertion loss performance of a simple DC pi filter built with feedthrough capacitors, compared to the same filter built with two-terminal capacitors. The shaded area indicates the extra performance obtained by using feedthrough capacitors in the filter design. Note that this graph is displaying insertion loss as opposed to imped-

RFI CORPORATION

a subsidiary of DGT Holdings Corp.

An AS9100 / ISO 9001:2000 Certified Company

100 Pine Aire Drive
Bay Shore, NY 11706
tel: 631.231.6400
fax: 631.231.6465
rfisales@rficorp.com

West Coast Regional Office
23635 Sonata Drive
Murrieta CA 92562
(951) 894-6519

The industry leader in providing cost effective solutions for complex EMI/EMC/RFI Filtration requirements

Demanding applications require expert engineering solutions. From EMI/EMC/RFI Power Filters to High Voltage Recon Mica Capacitors to Pulse/Power Transformers and various Magnetic components including Pulse Forming Networks (PFN), the most trusted names in Aerospace, Defense, Homeland Security, Medical, Industrial and Commercial markets, trust RFI.

EMI / EMC / RFI Filters

Custom & Multi Circuit Filters

QPL Filters M15733

Sprague / Filtron Filters

Power Line Filters

www.RFICORP.com

Your connector can be an EMI filter, too!

Quick, easy,
permanent
retrofit with
EESeal®
FilterSeals

Installs in seconds, no soldering,
just push in

Durable, conformal
elastomeric body

Meets wide barrage of
mil-standard tests

Pin-to-pin & pin-to-shell capacitors,
MOVs, resistors, shorts, etc.

AS9100 Certified



Custom designs to
you in just days!

Call for a free sample.



505.243.1423 • www.eeseal.com

U.S. Patent Nos. 3,686,697 and 6,013,979; Canadian Patent Nos. 2,200,868 and European Patent No. 6,801,815 - © 2011 Quell Corporation



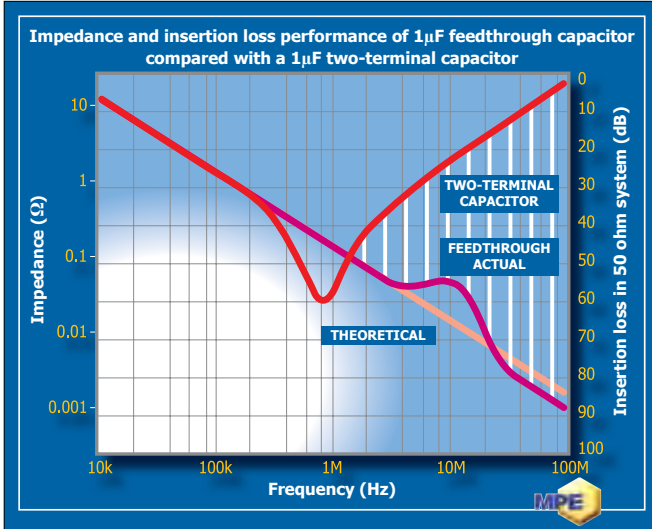

Figure 3. Impedance and insertion loss performance of a 1µF feedthrough capacitor compared with a 1µF two-terminal capacitor.

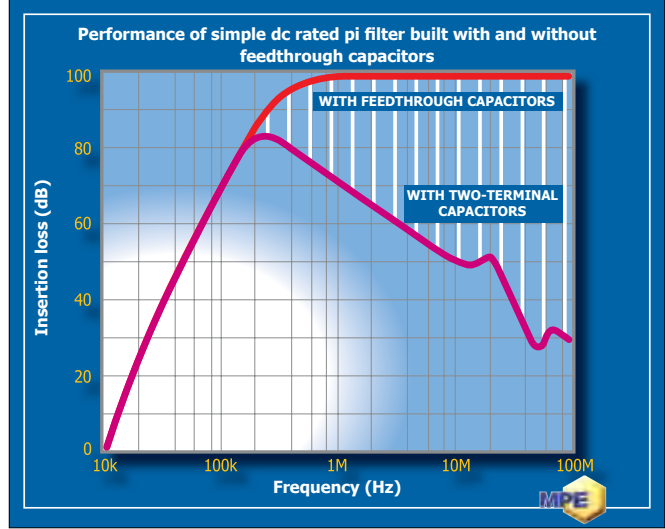

Figure 4. Performance of simple DC rated pi filter built with and without feedthrough capacitors.

ance on previous graphs so is plotted in the more usual direction for insertion loss.

Many older EMC specifications specify equipment emissions and susceptibility requirements only up to 30MHz, and usually a filter containing two-terminal capacitors will be adequate to comply with these specification requirements. Newer specifications are now

demanding EMC compliance up to 1GHz or beyond. This is to provide some protection against the effects of increased high-frequency noise pollution generated by faster processors, mobile phones, faster power control switches and so on.

The user should be aware that, even if his equipment has a CE mark to demonstrate compliance with existing

EMI FILTERS

Syfer has an unrivalled range of EMI filter products, and a commitment to product innovation.

Like the surface mount Pi filters, where we offer the highest capacitance and voltage in the market.

We consider flexibility to be the key, not only with new ranges being continually developed, but also with custom solutions.

INNOVATIVE, WORLD-CLASS CERAMIC COMPONENTS

www.syfer.com

CERAMIC & MICROWAVE PRODUCTS
Electronic Components & Microwave Solutions
A DOVER COMPANY

BSC FILTERS • DOW-KEY MICROWAVE • NOVACAP • SYFER TECHNOLOGY
DIELECTRIC LABORATORIES • K&L MICROWAVE • POLE/ZERO • VOLTRONICS

SINGLE PHASE AC AND DC FILTERS



FMW-41: All purpose, standard or medical filter. 1-10A, 125/250 VAC
FMW-55: 10-20A, 125/250 VAC, quick connect terminals



FMAB: For industrial applications such as frequency converters and inverters, 12-50A, 125/250 VAC, screw terminals



5500: Ultra compact, standard or medical 1-10A, 125/250VAC, PCB mount
FMAB 72: Aluminum case for optimal shielding, 2-16A, 125/250VAC, PCB mount



FMBB: For standard and industrial applications such as stepper motor drives and UPS systems, 8-25A, 125/250 VAC, screw terminals



FMBB NEO: Type F has excellent low frequency attenuation, 1-16A, 125/250 VAC, quick connect terminals



FMBB NEO: Compact Type C has high differential and common mode attenuation, 1-30A, 125/250 VAC, quick connect, nut and bolt terminals



FMBB NEO: Type D has excellent high frequency attenuation, 1-36A UL, 125/250 VAC, nut and bolt connections



FMW-150: 3-Stage filter, high broadband attenuation, 4-30A, 125/250 VAC, screw terminals



FMAB Rail: DIN rail mount, 1-Stage, industrial version for control cabinets 10-20A, 125/250 VAC



FMBB Rail: DIN rail mount for easy handling, standard or industrial versions, 2-Stage, broadband attenuation, 1-10A, 125/250 VAC



FMEB: DC filter for less noise and more stable DC power distribution. 5-30A, 43/80 VDC, quick connect or screw terminals



FMEC: Optimized for DC applications in IT and Telecom, 5-30A, +80 VDC, quick connect or screw terminals

3 PHASE AC AND DC FILTERS



FMAC ECO: Filter partially potted for lightweight, economical solution. 16-150A, 480 VAC, mounts upright or lengthwise



FMAD: High current filter w/neutral conductor, approved for high temperature applications, 6-550A, 275-480 VAC, screw clamp terminals



FMAC: High voltage, wide current range filter. High performance, ideal for PV inverter applications, 6-1100A, 480/520 VAC



FMAC-Out: Output filter for frequency inverters, 8-32A, high voltage rating 550 VAC , insulated safety screw terminals



FMW4-65: Compact filter for three phases, neutral conductor and ground, 3-20A, 250/440 VAC, quick connect terminals



FMAC SINE: Sine wave output filter, allows motor cables up to 200m under full load. 4-16A, 500/288 VAC, screw clamp terminals



FMAC SINE DCL: Sine wave output filter, features DC link circuit, allows motor cables up to 1000m under full load, 4-16A, 500/288 VAC



FMBC: High voltage rating for standard and industrial applications. 8-64A, 480 VAC, screw clamp terminals



FMBC ECO: Filter partially potted for lightweight solution, excellent price/performance ratio, 10-115A, 480 VAC, nut and bolt, screw terminals



FMBC Book Style: Very compact slim filter for frequency converters and inverters 10-115A, 480 VAC, screw clamp / flexible wire terminals



FMBC NEO: Compact size, fits in tight spaces with excellent attenuation, 7-180A, 480/520 VAC, screw clamp terminals



FMBD NEO: Terminals for 3 phases, neutral conductor and ground, intended for use in 4 wire systems. 8-200A, 300/520 VAC, screw clamp terminals



FMW4-81(95): Compact filter for frequency range 10kHz to 300MHz, 4-6A, 250/440 VAC, screw mount, quick connect terminals



FMAC Rail: 3-Phase, DIN rail mount, easy and time-saving handling, for control cabinets. 3-20A, 480 VAC



FMAD Rail: Compact DIN rail mount, 3-Phase w/neutral for industrial applications. 3-20A, 275-480 VAC



FMER SOL: For use in PV systems, **25-150A @600VDC, 250-1500A @1200(1000 UL) VDC**, screw clamp or copper bar terminals

Can't find what you need? Click here to fill out Custom Filter Requirements form.

EMC specifications, he could still experience problems. Unless his equipment is fitted with a suitable high-frequency filter containing feedthrough capacitors, it is unlikely to be protected against incident high-frequency interference above 30MHz. He could still therefore be responsible for problems caused by his equipment malfunctioning as a result of susceptibility to high-frequency interference.

Even when using feedthrough capacitors, performance can be compromised if the filter or capacitor is not mounted correctly to suitably screen the input from the output terminals. Bypass coupling owing to radiation and pick-up on interconnecting wires is more pronounced at higher frequencies, so greater care is needed to avoid this. The filter should ideally be mounted on or through a bulkhead to completely isolate input from output cables. Alternatively, screened cables should be used on one or both sides of the filter to prevent coupling. Figure 5 shows the effect of not mounting such a filter on a bulkhead or using screened cables. The shaded area shows the loss in high-frequency performance when the filter is not mounted or screened correctly.

ELECTROMAGNETIC INTERFERENCE

Electromagnetic Interference (EMI) occurs in two modes, asymmetric between line and earth, and symmetric be-

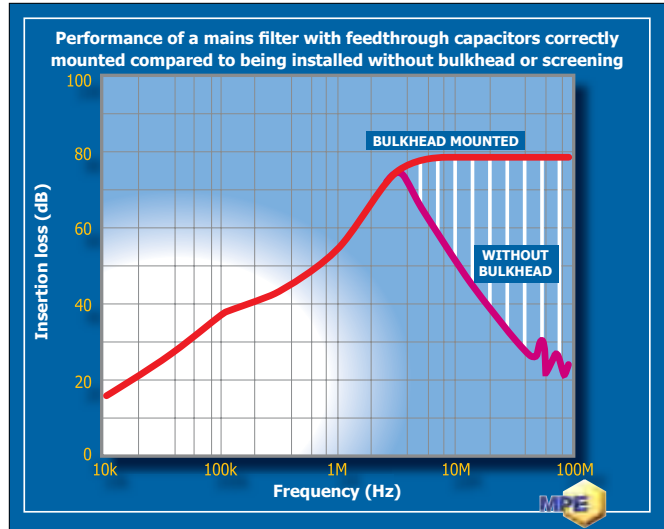

Figure 5. Performance of a mains filter with feedthrough capacitors correctly mounted compared to being installed without bulkhead or screening.

tween lines. Suppression components fitted to remove one mode of interference may have little or no effect on the other mode, which requires a separate set of components connected differently. When choosing a filter circuit, it is important to know whether only one, or both modes of interference require suppression, so that a filter contain-

LCR...
your Ultimate Source
for Military and
Commercial EMI Filters

Count on LCR to meet all your filter needs, including:

- **COTS and Custom Military:** MIL-STD-461, MIL-STD-220A; full custom available.
- **Commercial Off-the-Shelf:** power line and power entry filters, industrial and medical; UL, CSA and VDE; RoHS compliant.
- **EMC Test and Design:** total in-house capability for appliances, EN55014-1.

For details on these and a full range of other filter solutions, call or visit our website.

LCR-ELECTRONICS, INC.
ENGINEERED PRODUCT SOLUTIONS IN A CUSTOMER FOCUSED CULTURE
9 South Forest Avenue Norristown, PA 19401
(800) 527-4362 sales email: sales@lcr-inc.com
www.lcr-inc.com

TECH-NOVATION
to the Market
TOTAL EMI SOLUTION PROVIDER
EMI Problems? We've got Solutions!

Absorbing EMI Noise
ABSORBER SHEETS
NEW!

FERRITE SHEET FFS FERRITES
NEW!
For RFID, NFC Applications

EMI WINDOW SHIELDING FILM
Transparent Low Resistance

Excellent Conductivity in X, Y and Z axes
EZ-Foam
NEW!

SMT GROUNDING CONTACTS
Board Level EMI solution

THERMAL PADS
EMI + Thermal Dual Function

EMI Shielding Materials + Ferrite Cores
EMI TAPES
FERRITES

EMI GASKETS
FERRITES TILES
FOR MEDICAL CHAMBERS

Intermark USA Inc
www.intermark-usa.com
ph. 408-971-2055 fx. 408-971-6033
EMI Solutions • RoHS Compliance

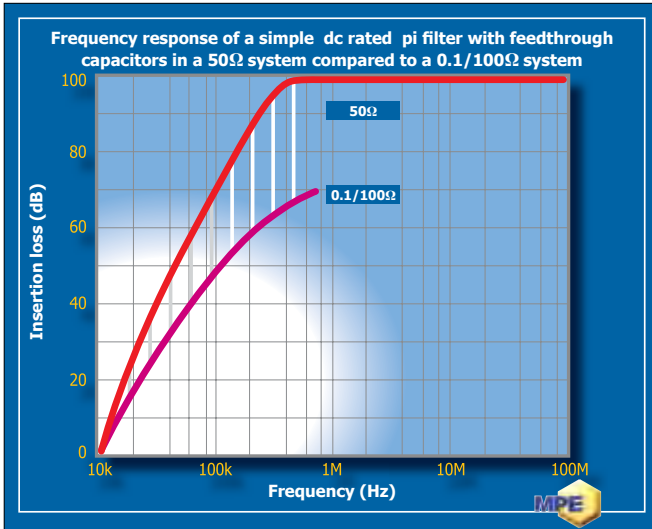

Figure 6A. Frequency response of a simple DC rated pi filter with feedthrough capacitors in a 50Ω system compared to a 0.1/100Ω system.

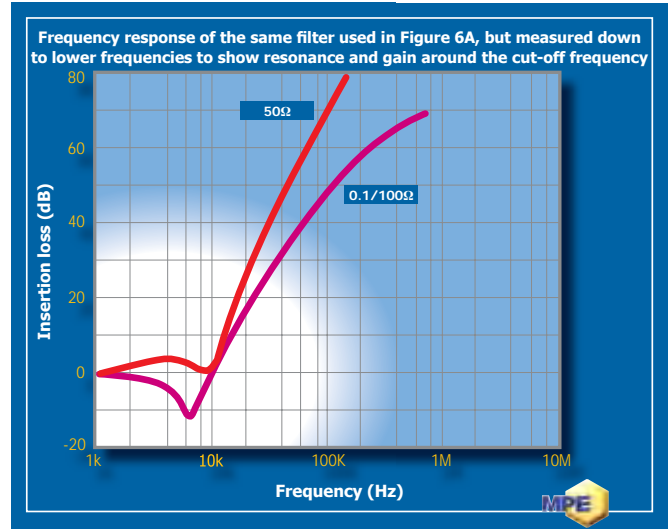

Figure 6B. Frequency response of the same filter used in Figure 6A, but measured down to lower frequencies to show resonance and gain around the cut-off frequency.

ing the necessary circuit components can be selected. In simple terms, asymmetric filter performance requires common mode inductors and capacitors from lines to earth, whereas symmetric mode performance requires single-line inductors and capacitors between lines.

Where single-line inductors are used in filters, they will saturate as load current increases, and performance

will be lost. The user should always check to see that performance figures quoted relate to full load conditions, as performance at full load current can be a lot worse than no load performance.

In most filtering applications, some asymmetric performance is normally required across the frequency

RADIUS POWER

Comprehensive EMI Solutions, On Time & On Budget

From design, quick-turn protos, and worldwide ISO9001 manufacturing, we are the superlative EMI solutions provider. The cornerstones of our mission are simple: Quality. Integrity. Service. Value. It is this commitment to total solutions without compromise that has led to our established position as a premier designer, manufacturer & distributor of EMI filters and magnetic products.

Plug into our comprehensive solutions. Radius Power is a leader in the design & manufacture of power products used to condition, regulate and govern electronic performance. The company provides a broad line of EMI Filters, Power Entry Modules, Power Transformers & Inductors to meet front-end requirements for AC & DC power line applications. We offer free pre-compliance testing for conducted emissions at our labs or yours! Bring us your EMI challenge & we will provide an optimized solution usually within 48 hours. Call Radius today.

714-289-0055 PH 714-289-2149 FAX 1751 N. BATAVIA ST. ORANGE, CA 92865

www.radiuspower.com

spectrum up to 1GHz. Symmetric performance, where needed, is usually only required below about 10MHz. Some symmetric performance is often provided by board level components.

The insertion loss performance of filters and suppression components is always quoted in a 50Ω system. This has traditionally been considered to represent the characteristic impedance of power lines at radio frequencies. With the widespread use of switching power supplies and power controllers, a much lower source impedance is now more typical. In such cases, a different performance will normally be provided by the capacitor or filter compared to the 50Ω performance shown in the catalogue or datasheet. For most simple filter circuits used in these applications, the actual performance obtained will be worse than expected.

Figure 6A shows an example of the performance of a simple pi filter in a 50Ω system compared with that measured in an impedance of 0.1/100Ω (0.1Ω source and 100Ω load impedance) which might be more typical for a switched mode power supply application. The shaded area shows the significant loss in performance produced in the practical system compared to the quoted 50Ω figures. Although the graph shows a filter with feedthrough capacitors as an example, a filter using two-terminal capacitors would show a similar reduction in performance

in the different impedance system. To obtain the required performance in the practical system, it is necessary to tailor the filter circuit to obtain a maximum impedance mismatch between filter and system impedance. This usually means using a filter with an inductive input to face a low impedance noise source.

Another issue of which many users are unaware is that filters can actually produce a gain at certain frequencies due to the mismatch in the impedance between the filter and the source and load impedances. This gain usually occurs at around the cut-off frequency of the filter and is often not apparent or not present when the filter is measured in a 50Ω system. However, in a more practical situation where the source and load impedance are not 50Ω, then the gain can be significant at around 10dB or more.

As an example of this, Figure 6B shows a measurement of the same filter as used in Figure 6A but measured down to lower frequencies to show this effect. It can be seen that, in a 50Ω system, there is a resonance around the cut-off frequency of 10kHz but no gain. However, the same filter measured in a 0.1/100Ω system does show a gain of around 12dB at 7kHz.

It must be stated that, although this gain is real, its magnitude and frequency will depend on the actual source and load impedances of the practical circuit, as well as the component values used in the filter circuit. If there is no

EMI noise present at the frequency of the gain, then there will be no gain, so the phenomenon should be of no concern. This will usually be the case in practice, as the filter will normally be designed for filtering higher frequency noise. However, there could be applications where there is an issue, and the user should be aware of this possibility.

STANDARD RANGES

There are many types of simple circuit filters available from numerous manufacturers, but most of them could be subject to some or all of the problems described above when used in certain applications. Becoming increasingly important are standard ranges of feedthrough capacitors, and filters incorporating feedthrough capacitors, which are designed to address some or all of the above problem areas. Some of the standard ranges of filters now available not only incorporate feedthrough capacitors but also have filter circuits designed to give the best response with low source impedance. Some manufacturers' catalogues now also quote performance in both 50Ω and 0.1/100Ω systems, which is more helpful.



F/R Your Signal Solution®

Since 1952 we have provided ferrites for your signal solutions. We are committed to developing with you as technology advances and needs change for EMI Suppression, Power, and RFID Antenna Applications.

Fair-Rite places the highest value on quality, engineering, and service. Our experienced team of engineers can assist with new designs and technical support.

Fair-Rite Products Corp.
www.fair-rite.com

P.O. Box 288, 1 Commercial Row, Wallkill, NY 12589-0288 USA
Phone: 1-888-FAIRRITE (324-7748)/845-895-2055 • Fax: 1-888-FERRITE (337-7483)/845-895-2629
E-mail: ferrites@fair-rite.com



Figure 7. Standard range of equipment filters incorporating feedthrough capacitors.



Figure 8. Standard filter for switched mode power supplies incorporating feedthrough capacitors and offering good performance in a 0.1/100Ω system.

Figure 7 shows an example of standard filters incorporating feedthrough capacitors, and which have bulkhead mounting to provide optimum high-frequency performance.

Figure 8 shows an example of a standard filter designed for switched mode power supply applications to offer good



Figure 9. Standard ranges of feedthrough capacitors.

performance in a 0.1/100Ω system.

As an alternative, Figure 9 shows an example of a standard range of feedthrough capacitors, which will offer excellent, cost-effective, high-frequency performance where full filter performance is not needed.

SUMMARY

This discussion has identified a few pitfalls, which can cause the anticipated filter or capacitor performance not to be achieved in practice. If a standard catalogue filter is to be used, then the user should ensure that the selected filter design addresses any problem areas above relevant to the application.

This may involve the selection of a slightly more specialised filter. For critical applications, the best approach is to obtain advice on the selection of the best filter circuit to use from a specialist filter company with established practical experience in filtering for EMC. The supplier should be familiar with the type of problems discussed here and therefore be able to provide rapid and accurate advice on the most cost-effective solution for a given application.

JAN NALBORCZYK graduated from Birmingham University, UK, with a BSc degree in Physics in 1973. He has worked for MPE Ltd since 1979 and is currently Technical Director of the company, which is based in Liverpool, UK. Email: jnalborczyk@mpe.co.uk

Environmental Test & Design (ETD)

shock • vibration • temperature • acoustics • HALT • HASS • eco design • waste • sustainability

Focusing on the inter-relationship between electronic products, systems and devices and their environments

Visit www.etcnews.com to subscribe today

Eliminating the Need for Exclusions Zones in Nuclear Power Stations

PHILIP F. KEEBLER

EMC Group, Electric Power Research Institute
Knoxville, Tennessee, USA

Utilities operating nuclear power plants have been dealing with electromagnetic interference (EMI) problems for over two decades. Many early problems that affected the operation of instrumentation and control (I&C) equipment in plants stemmed from the use of wireless transmission devices (WTDs) (e.g., radio walkie-talkies, cellular phones, etc) inside the plant in the vicinity of system cabinets and cable trays carrying bundles of cables. A simple and partially effective method of reducing EMI events caused by WTDs has been to mark off *exclusions zones* around system cabinets and areas where I&C equipment is installed. The use of these zones has presented some problems for existing plants. For example, some plants have had to expand the area of some zones that became ineffective upon the use of new WTDs that evidently presented an increased risk to the operation and EMI protection of I&C equipment. The sizes of some expanded zones are larger than 2,000 square feet. In addition, some zones encroach upon human traffic areas used by plant personnel to move from area to area within a plant.

Exclusion zones have also been recognized as a problem in the design of new plants. Some plant planners and designers have elected not to use exclusion zones realizing that even a well-planned pro-

gram designed to limit the use of WTDs in these zones simply presents too high of a risk in causing an EMI event. Success of the exclusion zone strategy depends upon limiting the use of WTDs in those zones. Plant engineers and technicians must be able to use their WTDs in areas close to I&C equipment during maintenance and troubleshooting and possibly even in situations where cabinet doors must be open. Moreover, controlling the inventory of WTDs, especially radio walkie-talkies, will also present problems for plant staff. If radios are categorized by power level, then a plant worker may need a low-power radio when none are available. In this situation, a high-power radio may be the only option available during an emergency situation in the plant.

This article is Part 1 of 2 addressing the issue of exclusion zones in existing plants. Past EPRI research has provided useful guidance in EMC helping to avoid EMI events given the state of plant EM environments in the last 17 years. However, with increasing use of digital I&C equipment in existing plants, the planned widespread use of this equipment in new plants, and the increasing demand to use WTDs in nuclear plants, changing EM environments require the development of new and more effective approaches to manage EMC and the risks associated with EMI events in the plants of today and tomorrow.

EMI/RFI Filters



- Competitive Prices
- Short Lead Times
- Quick Reply to RFQs
- Fast Prototypes

- Standard Filters
- Custom Designs
- Pb or Pb-free Designs
- Made in the USA



instec
FILTERS



www.instec-filters.com
sales@instec-filters.com
716-307-8542

GOWANDA®

Your QPL Source for Magnetics

- Mil-Prf-83446, Mil-Prf-27,
Mil-Prf-39010

- Standard or
Custom Designs

- In-House
Environmental
Lab Services

- AS9100
ISO9001
ISO13485



GOWANDA ELECTRONICS

Tel: 716.532.2234

Email: sales@gowanda.com

www.gowanda.com/QPL

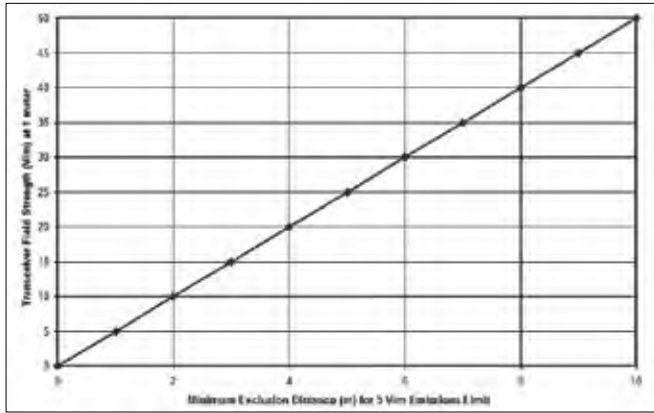

Figure 1. Recommended minimum exclusion distance (in meters) as a function of transceiver field strength (V/m) at 1 meter. (EPRI TR-102323 (1997) Revision 1).

BACKGROUND – HISTORY OF EXCLUSION ZONES IN PREVIOUS EPRI REPORTS

Nuclear power plants require a very high degree of protection from EMI. To achieve this, previous guidelines¹ published in a series by the Electric Power Research Institute (EPRI) used a methodology of performing plant electromagnetic (EM) surveys and from that data establishing recommended emissions and immunity levels, tests and EM management strategies. EPRI TR-102323 Revision 1 states in its abstract:

Nuclear power plants undertaking digital upgrades have been required to conduct expensive, site-specific electromagnetic surveys to demonstrate that electromagnetic interference (EMI) will not affect the operation of sensitive electronic equipment. This study was prompted by utilities desiring a more complete understanding of the EMI problem and to provide technically sound alternatives. Based on the emissions levels and expected types and levels of interference in nuclear power plants, guidelines for equipment susceptibility tests were developed. ... the levels are conservative based on the analyzed data. The working group defined specifications to obtain additional emissions data to validate these guidelines, develop a basis for equipment emissions testing, bound highest observed emissions from nuclear plants and eliminate the need for site surveys. The report includes minimum EMI limiting practices and guidance on equipment and plant emission levels.

One of the major changes made from the original report by the first revision (Rev. 1) was “an increase of the margin between the allowable plant emissions limit and the susceptibility limit from 6 dB to 8 dB”. However, a

¹ *Guidelines for Electromagnetic Interference Testing in Power Plants: Revision 1 to TR-102323-R1*, EPRI, Palo Alto, CA: January 1997.

Guidelines for Electromagnetic Interference Testing of Power Plant Equipment: Revision 2 to TR-102323, EPRI, Palo Alto, CA: November 2000. 1000603.

Guidelines for Electromagnetic Interference Testing of Power Plant Equipment: Revision 3 to TR-102323, EPRI, Palo Alto, CA, and the U.S. Department of Energy, Washington, D.C.: 2004. 1003697.

technical basis is not given in the report for the change. A discussion of the 8 dB buffer is provided in Chapter 7 of that report stating:

The limit for plant emissions was chosen to be 8 dB below the recommended equipment susceptibility testing level ... This limit is selected only to provide a reference point by which the utility engineer may determine if the emissions data from his plant are adequately bounded by the recommended susceptibility testing levels, thus allowing application of the generic susceptibility limits in this report. The plant emissions limit was chosen to be 8 dB below the recommended susceptibility levels to provide additional conservatism in when determining if the recommendations in this report can be applied to a particular facility.

While the reports utilize a strategy of studying plant emissions, and from that and other information, developing a EM protection plan, even in the conclusions of Rev. 1 in that report, the danger of relying too heavily on plant EM survey data is noted.

Operating experience from group members has shown that the nuclear power industry EMI/RFI problems are primarily due to infrequent transient interference and not steady-state EMI. Transient interference is well understood and documented in various industry standards. The industry standards do not require site emissions testing (mapping), but instead define equipment susceptibility testing levels based upon expected maximum plant EMI/RFI levels. Steady-state emissions recorded over a short period of time are unlikely to capture a transient event. The only EMI/RFI emitters that could affect digital equipment operation are portable transceivers. It is reasonable to conclude that steady-state mapping is not useful for identifying threats to digital systems.

Based on an understanding of sources of EMI in nuclear power plants, generic emissions measurements were performed to characterize both steady-state and transient EMI. Procedures were developed to describe the highest observed environment for key safety systems.

What is evident is that while previous versions of the

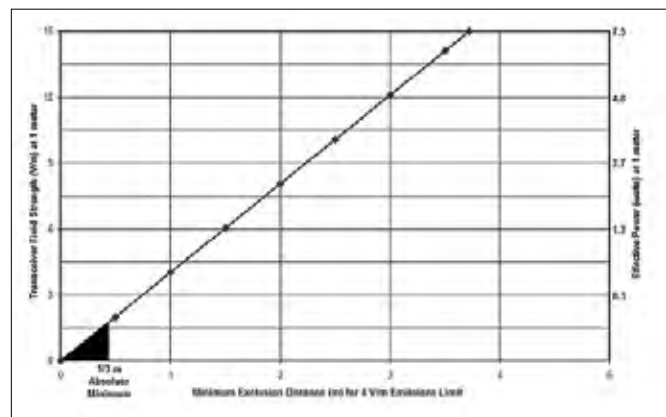

Figure 2. (Figure 6-1 in EPRI TR-102323 Rev. 2) Recommended minimum exclusion distance (in meters) as a function of transceiver field strength (V/m) at 1 meter. (EPRI TR-102323 (2000) Revision 2).



Our vertical integration gives you custom specialty connectors FAST!

“ Our specialty connector team is committed to producing custom EMI filtered and unfiltered connectors with the industry’s shortest lead times. We make our own planar and tubular capacitors, connector shells, shields, seals and grommets. And our expertise in finding the ideal EMI filtering method means you’ll get a higher performing connector, 100% tested for critical electrical parameters. Give me a call to see how we’ll design and build an audio, circular or hermetically sealed connector specifically for your military, commercial or industrial application.”

Dave Arthurs
Product Application Engineer
Spectrum Control



Put our innovative new products & problem-solving expertise to work for you!



Coaxial Filters & Interconnects



Power Filters & Film Modules



Specialty Connectors & Harnessing



Advanced Ceramics

At the NEW Spectrum Control, we’ve expanded our product capability to include a wider range of sophisticated components and assemblies. Our engineering teams continue to provide custom application-specific solutions exceeding our customer’s mechanical, electrical and power requirements. The Spectrum design process begins with our extensive library of standard components, which we frequently develop into custom assemblies offering you a more complete, high performance solution... saving you time and money.



Check out our **NEW Specialty Connector Video** @ SpecEMC.com/specvid

See how our expertise can work for you, call **888.267.1195** or visit **SpecEMC.com**



SPECTRUM CONTROL

part of **api** technologies corp.

report gave a central role to data obtained in plant EM surveys, they also recognized the dangers of relying on that data exclusively. In particular, the fact that most interference events occur due to infrequent, transient events was recognized. Guidance solely centered around the statement, "The only EMI/RFI emitters that could affect digital equipment operation are portable transceivers." must be revised to address the risks posed by the broader availability and use of intelligent WTDs that are appearing in existing plants as well as the ones that will be used

in new plants. While certainly portable transceivers are a well identified risk, EMI events caused by the use of today's modern cellular telephones and other WTDs in the vicinity of I&C equipment present real risks that must be addressed in any plan defining the management of EMC for nuclear plants.

After surveying the data available on plant EM environment, both steady-state and transient, a strategy is recommended for assuring the required level of interference protection. Emissions and immunity levels and tests

are recommended for equipment. In order to assure that the immunity levels are not exceeded, the previous versions of the EPRI TR-102323 report recommended the use of exclusion zones to keep electromagnetic and RF sources away from I&C systems. In Chapter 6 of Rev. 1, the following section discusses the method of providing protection from portable transceivers.

Controlling Emissions Sources

Portable Transceivers (Walkie-Talkies)

1. Proper administrative control of portable transceivers is necessary to protect EMI/RFI sensitive equipment. To provide at least 8 dB margin between the transceiver emissions limit (4 V/m) and the recommended equipment susceptibility limit (10 V/m), a minimum transmitter exclusion distance must be maintained. The transceiver field intensity can be estimated knowing the device power level and assuming the highest antenna gain factor of one according to the equation:

$$V_d = \frac{(30 P)^{0.5}}{d}$$

Eq. 4.1 from EPRI

TR-102323 Revision 1

where P is the effective radiated power of the transceiver in watts; d is the distance in meters from the transceiver and V_d is the field strength in volts/meter.

A portable transceiver with an effective radiated power of 3 watts generates a field strength of 9.5 V/m at a distance of 1 meter; 4.75 V/m at 2 meters and 0.95 V/m at 10 meters. The field strength falls off linearly with distance. Alternatively, the

EMC Lab cables: apples and You decide.



MegaPhase - Simply Better

- Rugged, crush-proof armor
- Ultra low insertion loss at 18, 26.5 and 40 GHz
- "Best in breed" shielding effectiveness
- Ideal for MIL-STD-461/462, DO-160, FCC and ETSI/EN testing

MegaPhase EM Series™ armored test cables are designed specifically for measurements in EMC lab environments where long cable lengths are subjected to walk-over, roll-over and pull forces – all with the lowest possible insertion loss and best shielding effectiveness. MegaPhase T&M cables are still the "Lowest Cost per Measurement"™ and the best overall value – period.

	MegaPhase EM18	Alternative OEM
Shielding Effectiveness	-120 dB	-100 dB
Insertion Loss	0.230dB/ft @ 18 GHz	0.782dB/ft @ 18 GHz
Operating Temp.	-67°F to 275°F	-67°F to 221°F
Lead Time	< 2 weeks	> 6 weeks
Product Warranty	12 months	6 months

Very typical Test cable comparison.



Excellence in RF Interconnects

2098 West Main Street, Stroudsburg, PA 18360
Tel: 1-877-634-2742 / 570-424-8400
Fax: 1-877-MegaFax / 570-424-6031
Email: fastquote@megaphase.com / Web: www.megaphase.com/fitch





Figure 3. An example of an innovative product (electronic book reader) that has an integrated cell phone transmitter.

transceiver field strength can be measured at 1 meter by testing in accordance with Electronic Industry Standard (EIA), EIA-329, Part II for Mobile Radios (20).

To determine the minimum transceiver exclusion distance:

1. Calculate the transceiver field strength for a distance, d of 1 meter using Equation 6.1.
2. Referring to Figure 1 (Figure 6-1 in EPRI TR-102323 Rev. 1), determine the minimum transceiver exclusion distance corresponding to the calculated transceiver field strength at 1 meter.

The minimum exclusion distance is required to ensure a margin of at least 8 dB between the transceiver emissions and sensitive equipment susceptibility testing levels. It is acceptable to increase the minimum transceiver distance or to even restrict their use in rooms where EMI/RFI sensitive equipment is located. The group recognizes the need to use these devices and has developed this guidance to support their use where transceivers and EMI/RFI sensitive equipment must operate in a shared environment.

As can be seen by the section title, "Portable Transceivers (Walkie-Talkies)," at the time the report was written the primary concern was walkie-talkies. The report next goes on to discuss arc welding and gives guidance on how to control emissions from that source. The report assumes that the types of portable wireless devices are limited, generally hardware based radios, serving primarily a single function, for practical purposes the only concern was walkie-talkies. For these transceivers, exclusion zones were an effective strategy. Since that time and increasingly, wireless is being utilized in a rapidly growing variety of ways.

Devices increasingly are using digital techniques, controlled by software, in contrast to the traditional hardware-based radios. The trend is more toward multi-function devices that are equipped to transmit on multiple bands using a variety of protocols. Witness the very popular eBook readers, which often are equipped with a cell phone interface, capable of operating on any of several frequency bands, using a variety of RF protocols and in

addition have a WiFi radio.

Increasingly, these devices aggressively use power control to maximize battery life. This means that the very same device may operate any of its several radios at different frequencies, using a different protocol and with a wide variation in its transmit power. MIMO (multiple-input, multiple-output) is widely used, allowing some devices to simultaneously transmit on multiple frequencies over any of several antennas. One highly successful smart phone has three different antennas built into its edge.

By the Rev. 2 of the EPRI TR-102323 report, the graph (shown in Figure 2 below) was modified to indicate a 4 V/m maximum emission limit, reduced from the 5 V/m defined in Rev. 1. In addition, a $\frac{1}{3}$ meter absolute minimum protection distance was added. The total distance scale was reduced from 10 meters to 4 meters. In addition, a second scale was added to the vertical axis showing the effective radiated power as well as the field strength. While the guidance and verbiage remains relatively the same, these differences indicate a growing need for additional EMC protection while also the difficulty of enforcing a exclusion zone over larger areas.

The Rev. 3 version of EPRI TR-102323 (2004) keeps the graph unchanged but refines the equation by adding a gain factor:

Tri-Mag, Inc. can build standard and custom design EMI filters for any industry:

MEDICAL, MILITARY & INDUSTRIAL

EMI FILTERS Single-Phase Filters • Three-Phase filters • Power Entry Modules • IEC Inlet Filters



Military

In addition to our wide range of standard products and our capabilities of building custom products to fit any application, all of Tri-Mag, Inc. Filters are built in the USA.



Medical



Medical

ROHS Compliance



Industrial



TRI-MAG, Inc.

your POWER Specialists

1601 N. Clancy Ct. Visalia, CA 93291 • Phone: (559) 651-2222 • Fax: (559) 651-0188
www.tri-mag.com • sales@tri-mag.com

$$V_d = \frac{(30 P)^{0.5}}{d}$$

Eq. 4.1 from EPRI TR-102323 Revision 3

While the changes in Rev. 2 and 3 of the EPRI TR-102323 report show a growing sophistication with both threat presented by portable transceivers and the difficulties of effectively implementing and enforcing an exclusion zone strategy, the view of portable transceivers remains relatively constant, with walkie-talkies remaining in the section title for all three revisions.

However, exclusion zones have in some cases failed to provide the required protection and are becoming increasingly burdensome to establish and enforce. This was the consensus, lead by one lead I&C engineer from a major US utility in the south who is currently designing advanced nuclear plants (with one under construction) at the December 2008 EPRI Nuclear EMI Working Group Meeting held in Washington, DC.

Interference incidents which have occurred give evidence to the failure of the exclusion zone strategy to provide the desired level of EMC protection for I&C systems in existing nuclear plants. There are many documented cases of malfunction and upset of I&C systems in existing plants caused by operation of a portable wireless transmission device (not always a walkie-talkie) too close to a

standard system cabinet with its doors closed.

At times, the failure is caused a source of EM energy was not recognized as such where an exclusion zone was not involved. One example occurred when the starter for a high intensity discharge (HID) lighting system (magnetically-ballasted) emitted an EM pulse when it attempted to strike a burned out lamp. Because the lamp was burned out, the starter repeatedly attempted to ignite it, emitting a continuing stream of EM pulses as a result. These emissions caused false detections to be registered in a radiation monitor located in another room in the plant. Radiated EM pulses from failed lamps were converted into a band of conducted emissions coupled into the signal loop of the radiation monitoring system. This caused frequent false alarms in the control room.

Another reason for the failure of exclusion zones is that with the increasing use of wireless technology, enforcement of exclusion zones is increasingly problematic. As wireless technologies are adopted and become a more significant part of the work equipment for various personnel, like maintenance workers and security personnel, conflicts are created when enforcement of the exclusion zone would deprive a worker of the tools they rely on to perform their job. This kind of conflict is likely to become increasingly prevalent as wireless technologies are used for an ever increasing variety of functions. Moreover, in today's culture of increased security required to protect nuclear plants and instantly respond to any potential threat, security and plant personnel, any restriction on the use of portable wireless devices will only limit the effectiveness of these personnel to protect the staff and the plant from a possible catastrophic situation. Security personnel must be focused on protecting the plant and staff without having to worry about tripping a critical safety-related I&C system.

The job of an I&C engineer and other plant personnel on the plant floor frequently involves the use of portable wireless devices when the doors of system cabinets are open. Communications are needed with other personnel out in the plant to maintain and troubleshoot I&C systems. Without these communications, standard procedures needed to bring I&C systems back up on line could not be performed.

Additionally, one concern of planners for advanced plants is that use of the exclusion zone strategy will lead to the 'approved use' and 'not approved use' of the inventory of portable wireless devices in the plant. If wireless device began to be segregated based on approval from whether or not they are likely to cause an EMI problem, additional confusion will result when plant personnel strive to manage this divided inventory. One engineering planner was worried that all 'approved' wireless devices would be in use by plant personnel when one was needed. This would result in the selection of a 'non-approved' device for use on the plant floor even though it might be against a plant's policy.

Today, plants are now approving the use of some cell

ELECTRONICS COOLING BUYERS' GUIDE APP



Access information from
thermal management
companies on your
mobile device

SEARCH "EC BUYERS' GUIDE" IN
THE APPLE APP STORE AND ANDROID MARKET

Electronics COOLING

electronics-cooling.com

phones and wireless telephones while not approving others. The decision to 'approve' or 'not approve' is sometimes based on misleading information, incorrect test results, incomplete test procedures, or data for the wireless device that may lead plant personnel to suspecting that a device may or may not cause an EMI problem.

Fortunately, exclusion zones are one of three methods for protecting equipment from electromagnetic interference (EMI). Those methods are:

1. Keep unwanted energy out of sensitive I&C equipment by separating the emitting equipment from sensitive equipment. This is the exclusion zone strategy.
2. Protect sensitive equipment from the unwanted energy by using additional shielding or filtering either at the system cabinet level or inside the cabinet but external to the sensitive equipment.
3. Design sensitive equipment to be inherently immune to the effects of unwanted energy.

In Rev. 3 and earlier versions of EPRI TR-102323, Guidelines for Electromagnetic Interference Testing of Power Plant Equipment, an exclusion zone strategy for dealing with portable transceivers, guided by a simple logic, implemented the first of these strategies.

ADVANTAGES & LIMITATIONS OF EXCLUSION ZONES

Exclusion zones have significant advantages in existing nuclear plants early on when there were fewer portable wireless devices. However, they have also presented a number of sound limitations, which will continue to be used with digital I&C upgrades in existing plants and rolled over to design advanced plants unless a different strategy is taken. Among the advantages of exclusion zones are:

- They are directly controlled by each individual plant.
- They can be customized to the specific needs and conditions in each plant or area of a plant.
- Exclusion zones do not require specialized training or equipment.
- They are not dependent on equipment vendors, outside labs or other external entities.
- They can focus on specific classes of equipment that are problematic.
- Exclusion zones do not increase the cost of equipment or require specialized equipment installation practices.

One of the very real advantages of exclusion zones is that they are directly under the control of each individual plant. A plant is not dependent on an outside entity, such as an equipment vendor or test lab. If the exclusion zone fails, it is because the plant where the failure occurred did not enforce it adequately. An exclusion zone can also fail in a sense if its bounded area is too small or if its dimensions are not adequate to provide EMC protection for the expected inventory of portable wireless devices used in a specific plant. Thus, the responsibility to maintain quality

control and enforce the exclusion zone rests with the plant, which will suffer the consequences if there is a failure.

A further advantage of exclusion zones is that they can be customized for each individual plant or for specific areas in a plant. For example, if a plant has one area in which the equipment is highly immune to interference, it may not need an exclusion zone in that area at all. However, another plant, using different equipment that is more interference susceptible may require a significant level of protection for a corresponding area. Also, a plant may adjust exclusion zones from time to time, such as relaxing them during maintenance activities, when an area is off-line, or when an I&C system is upgraded to a system thought to be more immune to electromagnetic energy. Exclusion zones offer a high degree of flexibility for local conditions.

Exclusion zones also do not require specialized training or equipment. RF testing is expensive and requires a high degree of expertise to do well. These factors increase the cost of testing and also increase the chance that testing may fall short of what is required. It is not uncommon for testing to be performed with inadequate equipment, by a non-accredited test lab or by personnel who are not appropriately trained and experienced. The use of exclusion zones avoids these issues.

Another advantage of exclusion zones is also an im-



**Artful
Craftsmanship
Superior
Service**

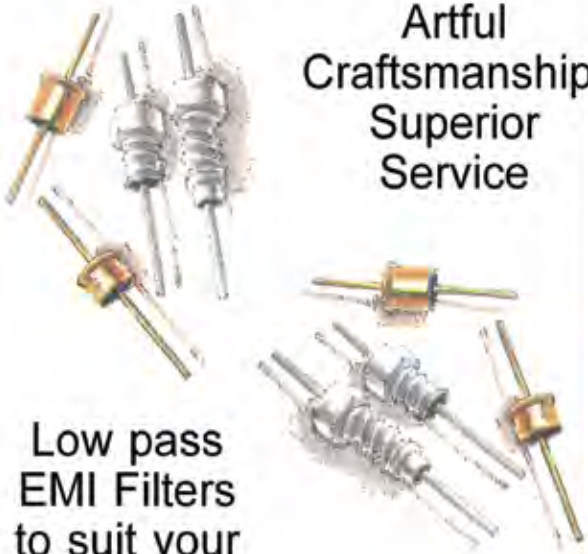

**Low pass
EMI Filters
to suit your
application**

An ISO 9001:2008 Company

**12750 59th Way North, Clearwater, FL, 33760
Sales@emifiltercompany.com 1-800-323-7990**

portant weakness. If only portable transceivers, especially walkie-talkies are the problem, then an exclusion zone can keep those devices away from I&C systems. This avoids requiring I&C systems take on the cost and complexity of providing significantly higher levels of immunity. If walkie-talkies are the problem, then keeping them away is an effective and efficient solution. How this becomes a weakness will be discussed later, under the disadvantages.

Exclusion zones also have the advantage that they do not increase equipment or installation costs. Requiring levels of RF immunity beyond what vendors are accustomed to will inevitably raise the price of the equipment. The typical pattern is that when vendors are required to meet new requirements they apply quick but inefficient solutions like add-on filtering and shielding not specifically designed for that equipment. Typically, they resort to expensive shielding and filtering. One reason for this is that they seldom have the expertise on staff to develop alternative solutions. It also occurs because they want to avoid the cost of equipment redesign and find a solution that simply protects their existing and typically vulnerable circuitry or equipment.

Over time vendors usually learn how to design equipment that has inherent RF immunity. This kind of solution typically adds little or even no cost to the equipment, but requires considerably more design expertise. This

approach is usually introduced as vendors acquire the requisite expertise on their staff and are driven to provide immunity and lower prices by competitive pressures. Design changes may also be introduced to enhance EMC protection after the vendor is made aware of an EMI problem, especially one that ended up costing them money back to the customer. The result is that in the long run requiring higher levels of RF immunity does not inherently raise the cost of the equipment much, but in the short term it typically does.

These advantages of exclusion zones are significant and explain why this strategy was adopted in earlier versions of EPRI TR-102323. It must also be noted that exclusion zones are very amenable to use in a hybrid strategy. Indeed, the EPRI TR-102323 report does not rely exclusively on exclusion zones, but recommends them as part of a EMI control strategy that includes testing for emissions and immunity. From this viewpoint, the question is not whether exclusion zones should be used or not, but rather is their use, coordinated with other components of a total control strategy optimal for the current and future EM environment that plants will operate in.

The disadvantages of exclusions zones are also significant and well understood by those who are responsible for implementing and enforcing them. These include:

- It can be difficult or even impossible to implement exclusion zones.
- Enforcement of exclusions zones is increasingly difficult and even impossible.
- They are the direct responsibility of each individual plant costing time and resources.
- Exclusions zones can take on different shapes and areas even across plants that use similar designs; there are enough differences in exclusions zones across these plants to create enough differences in the design and implementation of system-wide policies designed to limit the use of wireless transmission devices.
- Exclusion zones often come in conflict with the legitimate need to use wireless enabled technologies to perform necessary job functions.
- Exclusion zones are a product of oversimplifying the problem and as a result are a flawed solution.
- Exclusion zones must use general rules that are often overly conservative.
- Exclusion zones often cannot be fully implemented around I&C systems because of physical barriers (e.g., rails, steps, other equipment) in the way.
- Exclusion zones can extend into areas that must remain clear and walk way areas that must support the heavy traffic of plant personnel.
- Exclusion zones are designed to protect I&C equipment from EM energy emanating from a known inventory of wireless transmission devices (typically portable walkie-talkies). Plants strive to control the use of wireless transmission devices, especially cell phones, owned by contractors and visitors. If these devices are allowed in a plant, then specific exclusion zones may not

Curtis Industries/Filter Networks

INNOVATIVE ENGINEERING SOLUTIONS

Outstanding Performance and Selection on
RFI Power Line Filters and Terminal Blocks.

Filters

- GENERAL PURPOSE FILTERS
- 3-PHASE
- AC AND DC FILTERS
- CUSTOM FILTERS
- MILITARY FILTERS

Terminal Blocks

- BARRIER STYLE
- PCB MOUNT
- DIN RAIL MOUNTED
- CUSTOM MOLDING



Our engineering and sales departments are ready to address your filtering needs with results that are
PROFESSIONAL - QUICK - ECONOMICAL - QUIET.

For product information contact:

Curtis Industries/Filter Networks
2400 S. 43rd Street
Milwaukee, WI 53219
tel: 414-649-4200 or 1-800-657-0853

www.curtisind.com cisales@curtisind.com
www.filternetworks.com



Curtis Industries
A Div. of Powers Holdings, Inc.



ISO 9001 Registered

adequately protect I&C equipment.

Exclusion zones can be difficult or even impossible to implement. They require control of a substantial area around sensitive equipment. However, at times the required protection area is difficult or impossible to control. An example is an I&C system installed near a wall adjacent to an area where it is permissible to use wireless transmission devices, or an external wall, adjoining a parking lot. What radios will be in vehicles entering the parking lot is difficult to control, if it is possible to control them at all with any certainty. Especially when the required protection distance grows to be 3 to 10 meters, it expands beyond the typical room and takes in a significant area. Some exclusion zones take up a very large area of plant floor.

The explosive growth in the use of wireless makes enforcement of exclusion zones increasingly problematic. Wireless devices are now incorporating intelligent decision-making technologies and code making more effective use of unused spectrum. The cell phone illustrated in Figure 3 is an example. Wireless is used in a wider and wider variety of products and applications. It is increasingly difficult to even identify what is a wireless device. Even medical implants are including wireless transceivers, albeit to date those are operating at lower power. How do you enforce an exclusion zone if the transceiver is in an implant inside the body of a plant worker?

When exclusion zones are used, every plant must assign personnel and expend time and effort to implement and enforce them. When a plant elects to use a new wireless technology capable of reaching power levels higher than technologies previously used, new calculations must be made to determine the layout of new exclusion zones. It is not one zone that must be revised but many. (Why should plant personnel strive to keep exclusion zones updated when other more effective strategies can be applied?) This is an ongoing cost, using resources that typically are needed elsewhere. Further, enforcement of exclusion zones is an ongoing responsibility that has potentially significant consequences if there is ever a failure. Enforcement must be ongoing and vigilant to assure that there is never a failure. Assuring such continued vigilance typically requires overly conservative and redundant monitoring to assure continual and effective compliance.

Another problem with exclusion zones is that they regularly create conflicts between the need to protect sensitive I&C systems and the need to use wireless services. The increasing use of wireless for an ever expanding variety of purposes promises to make this kind of problem increasingly common. A worker uses and comes to rely on wireless tools to perform their job but then is told he or she cannot use the tools that have become necessary for their job in the exclusion zone, where they may be required to go to perform maintenance, maintain security or some other job function. These kinds of conflicts occur and create what appear to many as rules without reason.

These kinds of conflicts are exacerbated because exclusion zones must be implemented as general rules, without

regard for the differences in wireless services. If, for example cell phones are discovered to cause an EMI problem in a nuclear plant then all cell phones, in all frequency bands and at all power levels must be excluded. However, personnel will often discover that their cell phone creates no interference, making the exclusion zone seem arbitrary and needless. This may lead some plants to issue 'blanket approval' for the use of all cell phones—a strategy that presents undefined risks to the operation of I&C equipment.

The fact is that originally cell phones operated in the 800 MHz band, using RF power of up to two (2) watts. Today, most cell phones still use the 800 MHz band but are also equipped to operate in the 1,900 MHz band, where the maximum power is one (1) watt. Further, the 700 MHz band frequencies have already been auctioned, although equipment has not been deployed there yet. The Advanced Wireless Services (AWS) band is scheduled to be auctioned, adding frequencies up to 2,100 MHz. Other mobile services are moving forward in the 2,300 MHz and 3,500 MHz bands. The future will see an increasing variety of mobile services, using different frequencies and power levels. Exclusion zones must treat them all equally, not only because most people cannot tell one device from another, but increasingly devices can operate on multiple bands and which band they use is determined dynamically by the network.



CONEC® Filter Connectors
Intelligent EMI/RFI protection for your application

TECHNOLOGY IN CONNECTORS™

Integration of connectors with filter saves space on the printed board and reduced EMI/RFI problems.

- Filter D-SUB connectors
- Filter Combination D-SUB connectors
- Filtered 7W2/9W4 Connectors for μ TCA Power Supply
- Filter Adapters
- Filter Plates
- Customer Specific Filter Applications
- IP67 protected Filter Connectors

For more information, sample kits, spec sheets or pricing visit:

www.keiconn.com OR
sales@keiconn.com
800-325-0534

KENSINGTON ELECTRONICS INC.
 Not just products - Solutions!

A further complication is that cell phones and many other wireless services use very aggressive power control. They only use as much RF power as is necessary to sustain their communications link. Cell phones will vary their RF power by up to 15 dB, a factor of more than 30. The same cell phone in one location, where it has good signal conditions to the network, will operate at 1/30th the power as the same cell phone in another location with poor signal conditions. Exclusion zones must assume the worst and control these devices as if they are operating at maximum power. Indeed, the plant has no control over how much RF power they will use, and it is changing dynamically. So, how is the plant supposed to know if a cell phone provider changes the operation of its network? This could result in changing how the RF power levels are managed. The only option with the exclusion zone strategy is then to be conservative in order to assure the required level of protection.

The use of exclusion zones in existing nuclear plants comes from an analysis that finds portable transceivers, particularly walkie-talkies, to be the only EM threat, so simply keeping them away from I&C systems is an effective and efficient solution. But are portable transceivers the only problem? More specifically are portable transceivers a significantly worse source of EM fields than other sources? If they are, then exclusion zones are an effective remedy.

However, there are many sources of EM fields, both natural and man-made. Can a relatively low level of immunity in I&C systems provide adequate protection against most sources and then by using exclusion zones the more powerful fields from portable transceivers are effectively dealt with? In fact, exclusion zones only give the delusion of protection.

In particular, there are low-frequency, high-impact events that present a rare but important risk category. Two examples of low-frequency events that produce very high levels of EM are Electromagnetic Pulse (EMP) and terroristic use of EM fields. While these events are rare, they are real risks. If they do occur, should nuclear plants be protected against them? Having I&C systems with sufficient immunity to protect against portable transceivers also will increase their ability to withstand EM fields coming from other sources.

IN GENERAL PLANT ENVIRONMENTS

Exclusion zones have been used as an EMC control measure in a variety of plant environments, even those outside of the nuclear power industry. It can be an effective method for controlling EMI. A critical element in the use of an exclusion zone is the degree to which the zone can be controlled. The more reliably an environment can be controlled, the higher the effectiveness of the exclusion zone strategy. As the ability to control the environment is compromised, the effectiveness of the exclusion zone strategy also degrades. So, a fundamental requirement for an exclusion zone strategy to be effective is the ability to

control the environment around sensitive equipment. The exclusion zone strategy is not recommended when the area around sensitive equipment cannot be reliably controlled.

Two specific times of plant operation when exclusion zones collapse are when the plant is under unscheduled shutdown and when the plant is under scheduled shutdown. Under unscheduled shutdown, the number one goal of every single plant personnel is to work towards getting the problem resolved and the plant back online. When power is not being generated, money is lost and lots of it. Plant workers simply work without interruption and barriers to aid in getting the plant up and running again. During this time, extremely heavy radio usage takes place. However, not all systems are fully offline. This is absolutely the case in nuclear power plants. Thus, a good number of I&C systems will need to remain online to preserve certain safety functions. Some of these systems may employ the use of exclusion zones.

Under scheduled shutdown, the plant and its personnel are given a fixed number of days to perform the scheduled work (typically refueling). Plant personnel are rewarded for getting the work done and the plant back online early. During this time, certain I&C systems must be functional in order to get the work done correctly and on time. Some of these systems may employ the use of exclusion zones.

The exclusion zone strategy also comes under pressure when competing legitimate interests come into conflict. For the purposes of EMC, an exclusion zone might be desirable. However, there might be very legitimate reasons why wireless equipment should be brought into close proximity to equipment inside an exclusion zone. Maintenance personnel are more effective if they can use their cell phones or walkie-talkies to verify equipment functionality or get needed technical support from another plant engineer. Many exclusion zones are so large that troubleshooting some I&C systems requires the use of three personnel: one at the system cabinet to observe indicators and make measurements, one in the middle of the exclusion zone acting as a 'repeater' to deliver the message to personnel outside the exclusion zone so the information can be radioed to personnel in the control room or another area of the plant. Other examples are created when space is limited and different equipment must be put into close proximity, due to its functionality. There are a wide variety of reasons that can arise and put pressure on the use of exclusion zones.

A simple reason exclusion zones are problematic is that real estate inside a plant is in high demand and is generally expensive. Having a lot of unused space in any environment is generally inefficient. Spreading equipment out requires more building space, costing money. Often, the space simply is not available. However, even when space is available, it comes at a cost, usually a high cost. Mapping out an exclusion zone for a specific I&C system may permanently mark that area as unusable for any other function.

For these reasons, the use of exclusion zones is increas-

ingly rejected. Planners engaging in digital upgrades in existing plants and in specifying digital equipment for advanced nuclear plants do not want to see exclusion zones in their plants. Other methods of EMC control are found more effective. Shielding, filtering or improved immunity, but implemented at the right level, are increasingly the preferred methods for EMC control.

IN ADVANCED NUCLEAR PLANT ENVIRONMENTS

The disadvantages of exclusion zones become increasingly relevant when considering the environments of advanced nuclear power plants. Looking to the future, the use of wireless for communications, data transmission and sensor networks is a growing reality. The ability to exclude these services from areas where I&C systems operate is not only increasingly problematic but also undesirable. Indeed, some I&C systems will greatly benefit from wireless connectivity, for example, to distributed sensor networks. The ability to enforce an exclusion zone will be a growing problem as wireless is integrated into an ever increasing variety of equipment types. Therefore, a different method for providing the required level of protection is required.

CONCLUSION

This article, Part 1 of 2 on the topic of exclusion zones and their strategies in nuclear power plants, presented a history of the development and use of exclusion zones originally defined by EPRI research in the area of EMC for nuclear power plants. Early strategies served their purpose in a time when wireless devices were few. Moving towards a more effective strategy for protecting digital I&C equipment from radiated threats in plant environments requires an understanding of the advantages and disadvantages of exclusion zones as presented in this article. Effective and dynamic protection of digital I&C equipment against radiated threats must be an inherent part of I&C systems allowing plant engineers to focus on plant safety, operation, maintenance, and upgrades without the challenges presented by the use of exclusion zones. Nuclear power plants are facing more challenges, and those that can be resolved providing a higher degree of safety and reduced risk will help utilities maintain safe plants that are profitable. Part 2 of this article will address Elements of the Exclusion Zone Strategy with a focus on peeling back the layers of immunity for I&C systems to establish whole-system immunity.

BIBLIOGRAPHY

- [1]. Guidelines for Electromagnetic Interference Testing in Power Plants, EPRI TR-102323, Rev 1, Electric Power Research Institute, Palo Alto, CA, 1996.
- [2]. Guidelines for Electromagnetic Interference Testing in Power Plants, Revision 2 to EPRI TR-102323, TR-1000603, Electric Power Research Institute, Palo Alto, CA, 2000.
- [3]. Guidelines for Electromagnetic Interference Testing in Power Plants, Revision 3 to EPRI TR-102323, TR-1003697, Electric Power

Research Institute, Palo Alto, CA, 2004.

- Guidelines for Evaluating Electromagnetic and Radio-Frequency Interference in Safety-Related Instrumentation and Control Systems, Regulatory Guide (R.G.) 1.180, U. S. Nuclear Regulatory Commission, 1996.

PHILIP F. KEEBLER manages the Lighting and Electromagnetic Compatibility (EMC) Group at EPRI where EMC site surveys are conducted, end-use devices are tested for EMC, EMC audits are conducted and EMI solutions are identified. Keebler has conducted System Compatibility research on personal computers, lighting, medical equipment, and Internet data center equipment. The lighting tasks were associated with characterizing electronic fluorescent and magnetic HID ballasts, electronic fluorescent and HID ballast interference, electronic fluorescent and HID ballast failures, and electronic fluorescent and HID lamp failures. Keebler has drafted test protocols and performance criteria for SCRP tasks relating to PQ and EMC. He served as editor developing a new EMC standard for power line filters, IEEE 1560.

Looking for more information on this topic? Search *Interference Technology's* extensive archive of technical articles at www.interferencetechnology.com

Need an *EMI Filter*?



Do you need help meeting your EMI/EMC requirements? Did you just fail your EMI test? Is physical size a limitation?

IT'S TIME TO GET WHAT YOU NEED.

- ▶ Custom filters in any shape/size/configuration
- ▶ Any voltage/frequency/current/power
- ▶ Prototypes through production

Visit Us Online!

www.captorcorp.com

For over 40 years, Captor's superior engineering and design has meant quality, economy, and outstanding service. Call now for more details.

Quality. Expertise. Solutions.

CAPTOR CORPORATION

5040 S. County Rd., Tipp City, Ohio 45371 • Phone: (937) 667-8484 • Fax: (937) 667-5133
www.captorcorp.com © 2007 Captor Corporation

fischer connectors

High performance
push-pull connectors



- Fast, easy and reliable self-latching system
- A range of over 10,000 standard connectors
- Customized connector and cable assembly solutions
- High quality, compact and lightweight construction
- Rugged design for harsh and demanding environments
- 10,000 mating cycles



www.fischerconnectors.com



Headquarters

Fischer Connectors SA
Saint-Prex - Switzerland
Phone +41 21 800 95 95
mail@fischerconnectors.ch

CABLES / CONNECTORS

Products & Services Index

CABLES & CONNECTORS

AEF Solutions
Alco Technologies, Inc.
Amphenol Industrial Operations
Brim Electronics, Inc.
Calbrooke Marketing Inc.
Captor Corp.
CONEC Corp. - USA
Electri-Flex Company
ETS-Lindgren
Federal-Mogul Corporation
Systems Protection
Fischer Connectors Inc.
Fotofab
Harwin
Hi-Tech Controls
Hi-Voltage & EMI Corp.
ITT Interconnect Solutions
Ja-bar Silicone Corporation
Lutze Inc.
PennEngineering
Positronic Industries
Potters Industries, Inc.
PSC Electronics
Qualtek Electronics Corp.
RIA CONNECT
Schaffner EMC, Inc.
Schurter Inc.
Sealcon
Spectrum Advanced Specialty
Products
Swift Textile Metalizing LLC
Teledyne Reynolds
Wilcoxon Research
Wurth Electronics Midcom Inc.

FIBER OPTIC CABLES

ETS-Lindgren

FILTER CONNECTORS

AEF Solutions
Captor Corp.
Curtis Industries / Filter Networks
Glenair Inc.
Heilind Electronics
Kensington Electronics Inc.
Spectrum Advanced Specialty
Products
Spectrum Control
Schurter Inc.

FILTER PIN CONNECTORS

Captor Corp.
Fischer Connectors Inc.
Kensington Electronics Inc.
Spectrum Advanced Specialty
Products

FILTER SEAL INSERTS

Kensington Electronics Inc.
Lamart Corp.

FILTERED POWER ENTRY MODULES

Americor Electronics, Ltd.
Captor Corp.
Curtis Industries / Filter Networks
Qualtek Electronics Corp.
Radius Power, Inc.
Schaffner EMC, Inc.
Schurter Inc.
Spectrum Advanced Specialty
Products
Tri-Mag, Inc.

RETROFIT FILTERS & CONNECTORS

Quell Corporation
Schaffner EMC, Inc.
Schurter Inc.

SHIELDED CABLE ASSEMBLIES & HARNESES

Brim Electronics, Inc.
Captor Corp.
Federal-Mogul Corporation
Systems Protection
Fischer Connectors Inc.
Fotofab
W. L. Gore & Associates, Inc.
Lapp USA
MegaPhase LLC
Swift Textile Metalizing LLC

SHIELDED CONDUITS

ANAMET Electrical, Inc.
Electri-Flex Company
Federal-Mogul Corporation
Systems Protection
Zero Ground LLC

SHIELDED CONNECTORS

Binder-USA
Fischer Connectors Inc.
Ja-bar Silicone Corporation
Kensington Electronics Inc.
Kycon
Lutze Inc.
PennEngineering

SHIELDED TUBING

Federal-Mogul Corporation
Systems Protection
Ja-bar Silicone Corporation
Kemtron Ltd.
MμShield Company, Inc.
Zippertubing Company

**1% of static is caused by radiation
left over from the Big Bang.**

The rest is your problem.

Electromagnetic News Report
Get it in print and online

For a free sample visit 7ms.com/enr
or call Brenda at 814.466.6559



SHIELDING

Products & Services Index

INTERFERENCE TECHNOLOGY'S 2012 Shielding Products & Services Index contains nearly 60 different categories to help you find the shielding, shielded rooms and enclosures, and other equipment, components, and services you need. Full details of all the suppliers listed within each category can be found in the Company Directory, starting on page 151. The EMC Products & Services Index is presented in its entirety, starting on page 142.

ANECHOIC CHAMBER CALIBRATION TO IEC 80-3

ETS-Lindgren
Panashield

ANECHOIC CHAMBERS

Albatross Projects GmbH
ETS-Lindgren
Videon Central Inc.

ANECHOIC CHAMBERS – FIRE PROTECTION

ETS-Lindgren

ANECHOIC MATERIALS

ETS-Lindgren
Fair-Rite Products Corp.

ARCHITECTURAL SHIELDING PRODUCTS

Alco Technologies, Inc.
Kemtron Ltd.

BACKSHELLS, SHIELDED ASSEMBLIES, TERMINATIONS

Federal-Mogul Corporation
Systems Protection
Kensington Electronics Inc.
Northern Technologies Corp.

BOARD LEVEL SHIELDS

3Gmetalworx World
W. L. Gore & Associates, Inc.
Kensington Electronics Inc.
Mech-Tronics
Photofabrication Engineering Inc.
Precision Photo-Fab, Inc.
Schlegel Electronic Materials
Tech-Etch, Inc.
United Western Enterprises, Inc.
Kemtron Ltd.

BRAID

Alco Technologies, Inc.
Calmont Wire & Cable, Inc.
Federal-Mogul Corporation
Systems Protection
Syscom Advanced Materials

CABINETRY & HARDWARE

FIBOX Enclosures
Fotofab

CONDUCTIVE CONTAINERS

MuShield Company, Inc.
Swift Textile Metalizing LLC
VTI Vacuum Technologies, Inc.

CONDUIT, ELECTRICAL, SHIELDED, MAGNETIC & RF

Federal-Mogul Corporation
Systems Protection
Ja-bar Silicone Corporation
Kemtron Ltd.
VitaTech Electromagnetics

CRT ELECTRO-OPTICAL SHIELDS

Dontech, Inc.
MuShield Company, Inc.

DIE CUT SHIELDING MATERIAL

Apex Die & Gasket Inc.
Dontech, Inc.
W. L. Gore & Associates, Inc.
Identification Products Corp
Ja-bar Silicone Corporation
Kemtron Ltd.
Orion Industries Inc.
P&P Technology Ltd.
Spira Manufacturing Corp.
Tech-Etch, Inc.

EMI GASKETS

ACS Industries, Inc.
Boyd Corporation
CGS Technologies
Connors Company
Fabritech, Inc.
GETELEC
W. L. Gore & Associates, Inc.
Insulfab
Intermark (USA) Inc.
Ja-bar Silicone Corporation
Kemtron Ltd.
P&P Technology Ltd.
Spira Manufacturing Corp.
Stockwell Elastomerics, Inc.
Tech-Etch, Inc.
United Seal and Rubber Co., Inc.
VTI Vacuum Technologies, Inc.

FACILITIES & SHIELDED ENCLOSURE SERVICES

AR Tech
Compac Development Corp.
DNB Engineering, Inc.
ETS-Lindgren
Rittal Corp.

FIBER OPTIC CABLES

ETS-Lindgren

FINGERSTOCK

Ja-bar Silicone Corporation
Kemtron Ltd.
P&P Technology Ltd.

Tech-Etch, Inc.

GROUNDING RODS

Intermark (USA) Inc.

GTEM CELLS

ETS-Lindgren
Fischer Custom Communications
Instruments for Industry (IFI)
Noise Laboratory Co., Ltd.

HARNESSES

Captor Corp.

HONEYCOMB SHIELDING

ETS-Lindgren
Intermark (USA) Inc.
Ja-bar Silicone Corporation
Kemtron Ltd.
P&P Technology Ltd.
Spira Manufacturing Corp.
Tech-Etch, Inc.

IRON CORE POWDERED MAGNETIC MATERIALS

Fair-Rite Products Corp.

MAGNETIC SHIELDING

VTI Vacuum Technologies, Inc.

MAGNETIC SHIELDING GASKETS

Kemtron Ltd.
Spira Manufacturing Corp.
VTI Vacuum Technologies, Inc.

MAGNETIC SHIELDS

VTI Vacuum Technologies, Inc.

MICROWAVE ABSORBERS

ARC Technologies, Inc.
ETS-Lindgren
Intermark (USA) Inc.
Kemtron Ltd.

MOBILE SHIELDED ROOMS

EMI Technologies, Inc.
Select Fabricators, Inc.
Source1 Solutions
Swift Textile Metalizing LLC

MRI SHIELDING

Dontech, Inc.
ETS-Lindgren
MuShield Company, Inc.
Select Fabricators, Inc.

RF SHIELDING GASKETS

ARC Technologies, Inc.
W. L. Gore & Associates, Inc.
Ja-bar Silicone Corporation
Kemtron Ltd.
P&P Technology Ltd.
Spira Manufacturing Corp.
Tech-Etch, Inc.
VTI Vacuum Technologies, Inc.

RF SHIELDING MATERIAL

Axonics, Inc.
Cybershield
Dexmet Corporation
Federal-Mogul Corporation
Systems Protection
Feuerherdt GmbH
W. L. Gore & Associates, Inc.
Intermark (USA) Inc.
Ja-bar Silicone Corporation
Kemtron Ltd.
P&P Technology Ltd.
Precision Manufacturing Group
Spira Manufacturing Corp.
Tech-Etch, Inc.
TWP Inc.
Universal Shielding Corp.

SCIF DESIGN CONSTRUCTION & MAINTENANCE

ETS-Lindgren

SHIELDED AIR FILTERS

ETS-Lindgren
Ja-bar Silicone Corporation
Kemtron Ltd.
P&P Technology Ltd.
Spira Manufacturing Corp.
Tech-Etch, Inc.

SHIELDED BUILDINGS

ETS-Lindgren

SHIELDED CABINETS & HARDWARE

MuShield Company, Inc.
Swift Textile Metalizing LLC

SHIELDED CABLE ASSEMBLIES & HARNESSES

Brim Electronics, Inc.
Captor Corp.
Federal-Mogul Corporation
Systems Protection
Fischer Connectors Inc.
Fotofab
W. L. Gore & Associates, Inc.
Lapp USA
MegaPhase LLC

Swift Textile Metalizing LLC

SHIELDED COMPONENTS

Federal-Mogul Corporation
Systems Protection
Ja-bar Silicone Corporation
Kensington Electronics Inc.
Schurter Inc.
Spira Manufacturing Corp.
VTI Vacuum Technologies, Inc.

SHIELDED CONDUITS

ANAMET Electrical, Inc.
Electri-Flex Company
Federal-Mogul Corporation
Systems Protection
Zero Ground LLC

SHIELDED CONNECTORS

Binder-USA
Fischer Connectors Inc.
Ja-bar Silicone Corporation
Kensington Electronics Inc.
Kycon
Lutze Inc.
PennEngineering
Schurter Inc.
Southwest Microwave, Inc.

SHIELDED DOORS

Dontech, Inc.
ETS-Lindgren
Swift Textile Metalizing LLC

SHIELDED ENCLOSURES

ClickFold Plastics
Electrorack Enclosure Products
EMP-tronic AB
IMS Engineered Products
Modpak, Inc.
MuShield Company, Inc.
Select Fabricators, Inc.
VTI Vacuum Technologies, Inc.

SHIELDED FANS

ETS-Lindgren
Spira Manufacturing Corp.

SHIELDED FUSE HOLDERS

Schurter Inc.

SHIELDED ROOM FILTERS

Captor Corp.
Dontech, Inc.
ETS-Lindgren
Fotofab
TDK-EPC Corp.

SHIELDED ROOMS

Comtest Engineering bv
ETS-Lindgren
Holland Shielding Systems BV
I. Thomas GmbH
R. A. Mayes Company, Inc.
Select Fabricators, Inc.

SHIELDED ROOMS, ACCESSORIES

Ad-Vance Magnetics, Inc.
Dontech, Inc.
ETS-Lindgren
Gaven Industries Inc.
Leader Tech, Inc.
National Technical Systems
Shielding Resources Group, Inc.
Swift Textile Metalizing LLC

SHIELDED ROOMS & ENCLOSURES

Alco Technologies, Inc.
Allied Moulded Products, Inc.
AR Tech
Braden Shielding Systems
Bud Industries
Captor Corp.
Comtest Engineering bv
E&C Anechoic Chambers Asia
Ltd.
EMI Technologies, Inc.
EMP-tronic AB
ETS-Lindgren
Fotofab
Frankonia EMC
Global EMC Ltd.
Holland Shielding Systems BV
IMS Engineered Products
Instruments for Industry (IFI)
K-Form, Inc.
Modpak, Inc.
Noise Laboratory Co., Ltd.
ORBIT Advanced
Electromagnetics, Inc. (AEMI)
R. A. Mayes Company, Inc.
Rainford EMC Systems Ltd.
Select Fabricators, Inc.
Source1 Solutions
Spira Manufacturing Corp.
Stahlin Enclosures
Swift Textile Metalizing LLC
Videon Central Inc.
VTI Vacuum Technologies, Inc.

SHIELDED ROOMS, LEAK DETECTORS / MONITORS

ETS-Lindgren

SHIELDED SCANS, MONITORS & CRTS

Dontech Incorporated

SHIELDED SWITCHES

Schurter Inc.

SHIELDED TRANSPARENT WINDOWS

Dontech, Inc.
Instrument Plastics Ltd.
Kemtron Ltd.
P&P Technology Ltd.
Tempest Security Systems Inc.

SHIELDED TUBING

Federal-Mogul Corporation
Systems Protection
Ja-bar Silicone Corporation
Kemtron Ltd.
MuShield Company, Inc.
Zippertubing Company

SHIELDING

3M Electronics Markets
Materials Division
A&R Tarpaulins, Inc.
Alco Technologies, Inc.
Amuneal Manufacturing Corp.
ANAMET Electrical, Inc.
ARC Technologies, Inc.
Autosplice, Inc.
Axonics, Inc.
Bal Seal Engineering, Inc.
Calmont Wire & Cable, Inc.
Central Coating Company
Chomerics, Div. of Parker
Hannifin Corp.
Cima NanoTech, Inc.
Connors Company
Dexmet Corporation
Dontech, Inc.
East Coast Shielding
Ed Fagan Inc.
Emerson & Cuming Microwave
Products, Inc.
ETS-Lindgren
Fabritech, Inc.
Federal-Mogul Corporation
Systems Protection
Feuerherdt GmbH
Field Management Services
Fotofab
W. L. Gore & Associates, Inc.
HFC Shielding Prod. Co. Ltd.
Insulfab
Intermark (USA) Inc.
Ja-bar Silicone Corporation
JEMIC Shielding Technologies
JRE Test, LLC
Kemtron Ltd.
Magnetic Radiation Laboratories
Magnetic Shield Corporation
MAJR Products Corp.
Mekoprint A/S Chemigraphics
MH&W International Corp.
MuShield Company, Inc.
Nolato Silikonteknik
Orbel Corp.
P&P Technology Ltd.
Plastic-Metals Technologies,
Inc.
Precision Manufacturing Group
RFI Controls Company
Roxtec
Rubbercraft
Saint-Gobain High Performance
Seals
SAS Industries, Inc.
Schurter Inc.
Soliani EMC SRL
Specialty Silicone Products

Spectrum Advanced Specialty
Products
Spira Manufacturing Corp.
Swift Textile Metalizing LLC
Syscom Advanced Materials
Tech-Etch, Inc.
United Western Enterprises, Inc
Universal Air Filter
Universal Shielding Corp.
Vanguard Products Corp.
Vermillion, Inc.
VitaTech Electromagnetics
WaveZero, Inc.
Zero Ground LLC
Zippertubing Company
Zuken
VTI Vacuum Technologies, Inc.

SHIELDING COMPONENTS

Tech-Etch, Inc.

SHIELDING FOILS

Federal-Mogul Corporation
Systems Protection
Ja-bar Silicone Corporation
Kemtron Ltd.
MuShield Company, Inc.
Tapecon, Inc.

SHIELDING MATERIAL, MAGNETIC FIELD

Federal-Mogul Corporation
Systems Protection
W. L. Gore & Associates, Inc.
Ja-bar Silicone Corporation
Kemtron Ltd.
Less EMF Inc.
Magnetic Shield Corporation
MuShield Company, Inc.
Spira Manufacturing Corp.
Vacuum Schmelze GmbH & Co.
VTI Vacuum Technologies, Inc.

SIGNAL LINE ISOLATION TRANSFORMERS

Kensington Electronics, Inc.

TEM CELLS

ASR Technologies Inc.
ETS-Lindgren
Fischer Custom Communications
Instruments for Industry (IFI)
Noise Laboratory Co., Ltd.

TEMPEST FILTERS

Captor Corp.
Curtis Industries / Filter Networks
Dontech, Inc.
Syfer Technology Limited
Spectrum Advanced Specialty
Products

TEMPEST SUPPRESSED PRODUCTS

Dontech Incorporated

Simple Method for Predicting a Cable Shielding Factor, Based on Transfer Impedance

MICHEL MARDIGUIAN

EMC Consultant
St. Remy les Chevreuse, France

For a shielded cable, an approximate relationship valid from few kHz up to the first cable resonance can be derived from its Transfer Impedance (Z_t) allowing to predict the cable shielding factor. This Cable Shielding factor, as a figure of merit, is often preferred by engineers dealing with product specifications and early design. Being not necessarily EMC specialists, they can relate it directly to the overall shielding performance required for a system boxes or cabinets.

This article comes up with very simple, practical formulas, that directly express the cable shielding factor K_r , given its Z_t and frequency.

INTRODUCTION

Expressing the effectiveness of a cable shield has been a recurrent concern among the EMC Community, and more generally for the whole Electronic industry. This comes from a legitimate need to predict, measure, compare and improve the efficiency for a wide variety of shielded cables like coaxial cables or shielded pairs and bundles, having themselves various types of screens: braids, foils, spiral, corrugated, woven etc .

However, when it comes to decide what would be a convenient, trustworthy characteristic for a cable shield, several

methods are in competition: Shielding Effectiveness (SE,dB), Surface Transfer (Z_t , Ohm/m) or Screen Reduction Factor (K_r , dB).

Although Transfer Impedance Z_t is a widely used and dependable parameter, SE or Reduction Factor K_r as a figure of merit are often preferred by engineers dealing with product specifications and overall design, because they can relate it directly to the whole shielding performance required for the system. It would be a nonsense to require 60dB of shielding for a system boxes or cabinets if the associated cables and their connecting hardware provide only 30dB, and vice-versa.

a) **Shielding Effectiveness**, as defined for any shielding barrier is given by:

$$SE \text{ (dB)} = 20 \log [E \text{ (or H) without shield}] / [E \text{ (or H) with shield}]$$

By illuminating the tested sample with a strong electromagnetic field, this approach is coherent with Shielding Effectiveness definition for a box, a cabinet or any enclosure, with SE being a dimensionless number. Since it would be unpractical to access the remaining E (or H) field inside a cable shield, meaning between the sheath and the core, it is the effect of this incident field that is measured instead, for instance the core-to-shield voltage.

However, there are several drawbacks to this method:

- It requires a full range of expensive instrumentation : generator, power

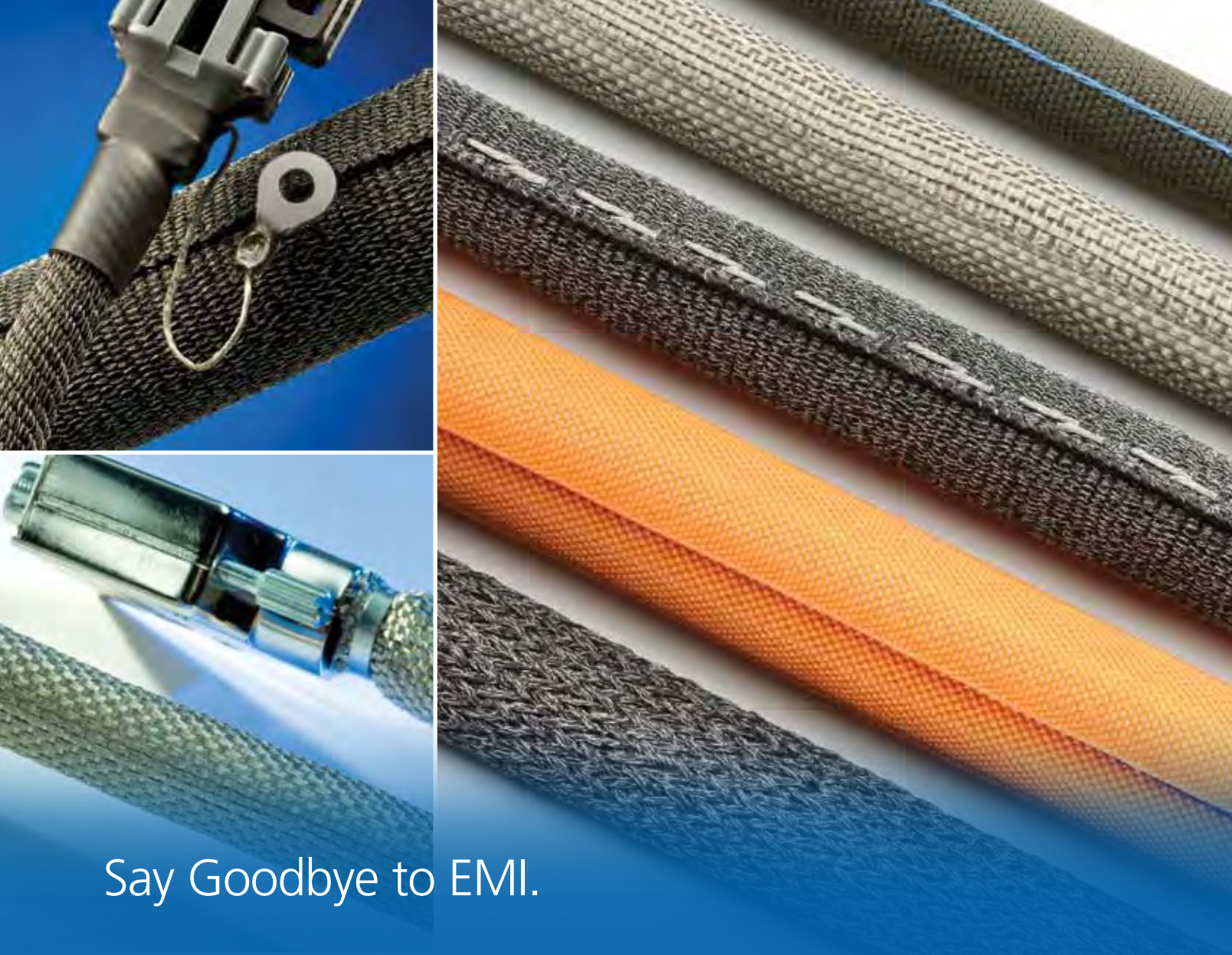

Say Goodbye to EMI.

Put an end to electromagnetic interference with Federal-Mogul's comprehensive family of EMI shielding. Our lightweight, flexible, textile-based self-wrapping sleeves install quickly and easily, pre or post assembly, to provide consistent protection from EMI. The innovative sleeving integrates into existing connector and grounding systems.

At Federal-Mogul, we have the testing, validation and engineering expertise to solve your most challenging system protection problems in aerospace, automotive, commercial vehicle and industrial applications.



www.federalmogul.com/sp

Contact your local sales office today:

systems.protection@federalmogul.com

USA: (1) 800.926.2472
Europe: (33) 3.44.39.06.06
Japan: (81) 45.479.0201
China: (86) 21.6182.7688

amplifier, antennas, shielded/ anechoic room (or stirred mode reverberating chamber) etc ...

- It carries the typical uncertainties of radiated measurements (mean value for ordinary radiated EMI test uncertainty being 6dB)
- It is very sensitive to the tested cable set-up: height above ground, termination loads and type of excitation in near field conditions. For instance, a transmit antenna at 1m from the test sample will create near field conditions for all frequencies below 50MHz. If the antenna is of the dipole family, the near-field will be predominantly Electrical, i.e. a high-impedance field and the SE results will look excellent. If the transmit antenna is a magnetic loop, the field will be a low-impedance H field, and the SE results will be much less impressive.

b) **Transfer Impedance** (Z_t), in contrast to SE, is a purely conducted measurement method, with accurate results, typically within 10% (1dB) uncertainty. But Z_t , being in Ohm/meter has a dimension and cannot be directly figured as a shield performance .

c) **Shield Reduction Factor, K_r** reconciles the two methods, by using the best of Z_t - the benefit of a conducted measurement, and of SE : the commodity of a direct figure in dB.

DEFINITION OF THE SHIELD REDUCTION FACTOR

We can define Shield Reduction factor (K_r) as the ratio of the Differential Mode Voltage (V_d) appearing, core-to-shield at the receiving end of the cable, to the Common Mode Voltage (V_{cm}) applied in series into the loop (Figure 1).

$$K_r \text{ (dB)} = 20 \log (V_d / V_{cm}) \quad (1)$$

This figure could also be regarded as the Mode Conversion Ratio between the external circuit (the loop) and the internal one (the core-to-shield line).

Slightly different versions of this definition are sometimes used like:

$$K_r \text{ (dB)} = 20 \text{ Log } (V_{d_2} / V_{d_1})$$

Where,

V_{d_1} : differential voltage at the receive end when the shield is not there (disconnected)

V_{d_2} : differential voltage at the receive end with the shield normally grounded, both ends.

This latter definition would be more rigorous, somewhat reminiscent of the Insertion Loss used in EMC terminology, i.e. it compares what one would get without and with the shield, for a same excitation voltage (see Fig. 1, B). This eliminates the contribution of the core wire resistance and self-inductance, since they influence identically V_{d_1} and V_{d_2} .

CALCULATED VALUES OF K_r FOR SIMPLE CASES, FOR LENGTH $l < \lambda/2$

Let express V_d , using the classical Z_t model, assuming that the near end of the cable is shorted (core -to-shield) :

$$V_d = Z_t \times l \times I_{\text{shield}}$$

where l : length of the shielded cable

Expressing the shield current, I_{shield} :

$$I_{\text{shield}} = V_{cm} / Z_{\text{loop}}$$

We can replace V_d by its value in the expression of K_r :

$$K_r = \frac{Z_t \cdot l \cdot (V_{cm} / Z_{\text{loop}})}{V_{cm}}$$

$$K_r = Z_t \cdot l / Z_{\text{loop}}$$

Z_{loop} itself is a length-dependent term, since it is simply the impedance of the shield-to-ground loop, which for any decent shield is a lesser value than that of the core wire plus the terminal impedances.

$$Z_{\text{loop}} (\Omega) = (R_{\text{sh}} + j\omega \cdot L_{\text{ext}}) \cdot l$$

where,

R_{sh} = shield resistance

L_{ext} = self-inductance of the shield-to-

ground loop

Replacing Z_{loop} by its expression:

$$K_r = \frac{Z_t \cdot l}{R_{\text{sh}} + j\omega L_{\text{ext}}}$$

Z_t (Fig. 2) consists in shield resistance R_{sh} and shield transfer (or leakage) inductance L_t .

Thus, we reach an expression for K_r as a dimensionless



MATERION

High Performance Alloy Strip for the Best Shielding Solutions



High end servers, routers and hubs rely on high performance materials for their shielding finger stock. Susceptibility to radiated and conducted emissions and other potential EMC problems can impair their functionality. Materion Brush Performance Alloys' copper beryllium strip alloy is a proven solution that can help eliminate these problems.

Learn more about our high performance alloy solutions by visiting our web site at www.materion.com/shielding, or contact our team today — Contact Jimmy Johnson at (216) 383-4014, or via email at jimmyjohnson@materion.com.

MATERION Brush Performance Alloys
www.materion.com/BrushAlloys
 Formerly Brush Wellman Inc.
 6070 Parkland Boulevard
 Mayfield Heights, Ohio 44124
 (800) 321-2076





Spira Manufacturing Corporation

EMI Gaskets & Shielding

Excellence by Design



NEW!!

Educational Seminar

- ◆ **Requirements in EMI Design for Compatibility & Longevity**
- ◆ **Shielding Effectiveness Test Methods Review & Accuracy**
- ◆ **Transfer Impedance Testing**

Visit our website:
spira-emi.com/whatsnew

For over **30 years** the EMC community has turned to Spira to solve their cost-sensitive and high shielding applications. Let us help make your next design easy, reliable & effective.

www.spira-emi.com

ISO9001
AS9100

Certified System



Groove & Surface Mounted Gaskets ◆ EMI & Environmental Sealing ◆ Easy-to-Use Honeycomb Filters ◆ O-Rings ◆ Connector Gaskets ◆ Die-Cut Gaskets ◆ Custom Gaskets

(818) 764-8222

sales@spira-emi.com

Contact us TODAY for free technical support, samples, and more information.

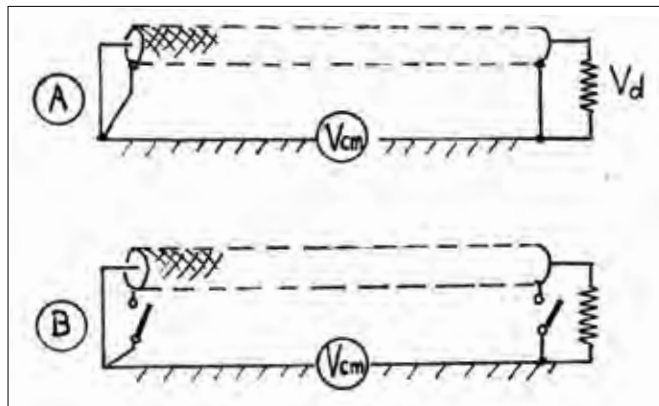

Figure 1. Conceptual view of the shield Reduction Factor (K_r), with two variations of the measurement set-up. In (B), the measurement compares the voltage measured at the termination with, and without the shield connected.

number, independent of the cable length:

$$K_r = \frac{(R_{sh} + j\omega Lt) \cdot l}{(R_{sh} + j\omega L_{ext}) \cdot l}$$

$$K_r = \frac{R_{sh} + j\omega Lt}{R_{sh} + j\omega L_{ext}} \quad (2)$$

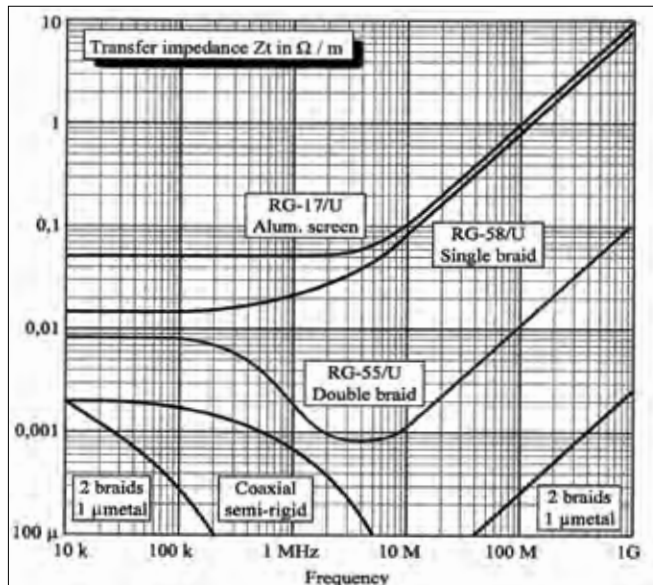

Figure 2. Some typical values of Z_t for several shielded cables.

This expression is interesting in that it reveals three basic frequency domains:

a) for Very Low Freq., where the term ωLt is negligible, Z_t is dominated by R_{sh} :

$$K_r = R_{sh} / (R_{sh} + j\omega \cdot L_{ext})$$

$$\approx 1 \text{ (0dB) below few kHz, since the lower term, loop impedance reduces to } R_{sh}$$

b) at medium frequencies (typically above 5-10kHz for ordinary braided shield):

$$K_r = (R_{sh} + j\omega \cdot Lt) / (j\omega \cdot L_{ext})$$

Reduction Factor improves linearly with frequency

c) at higher frequencies (typically above one MHz), up to first $< \lambda/2$ resonance:

$$K_r = Lt / L_{ext}$$

The Reduction Factor stays constant, independent of length and frequency.

A quick, handy formula can be derived, which is valid for any frequency from 10kHz up to first $< \lambda/2$ resonance:

$$K_r \text{ (dB)} = -20 \text{ Log} [1 + (6 \cdot \text{FMHz} / Z_t \text{ (}\Omega/\text{m)})] \quad (3)$$

The value for Z_t being that taken at the frequency of concern.

(*) Several formulas have been proposed in the past for expressing a cable shield effectiveness based on its Z_t . An often mentioned quick-rule is: K_r (or SE) dB = 40 - 20 Log ($Z_t \cdot l$). Although it are correct above the ohmic region of Z_t , it can give widely optimistic results, like 50dB or 70dB at 50/60Hz where an ordinary shield has no effect at all against Common Mode induced Interference.

CALCULATION OF K_r WHEN LENGTH IS APPROACHING OR EXCEEDING $\lambda/2$

When the dimension of the cable reaches a half-wave length, one cannot keep multiplying $Z_t(\Omega/\text{m})$ by a physical length which is no longer carrying a uniform current. In fact, the "electrically short line" assumption becomes progressively less and less acceptable when cable length " l " exceeds $\lambda/10$.



A Seamless EMI & RF Solution For Cumbersome Cables



Cables Coated with **WAVEX Z**

- Maximize Signal Integrity
- Pass Compliance Testing
- Eliminate Ferrite Chokes
- Streamline Cable Assemblies



WWW.ARC-TECH.COM/CABLES

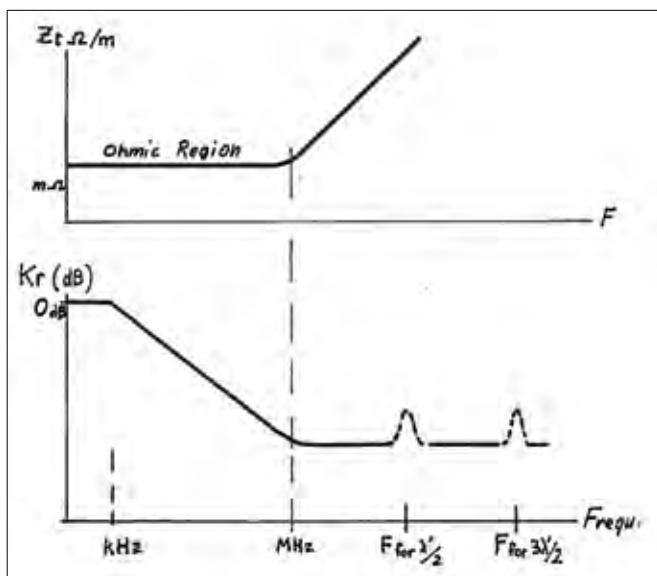

Figure 3. Conceptual view of the K_r behavior above resonance. Even with a good quality shield, the periodic shield current humps at odd multiples $\lambda/2$ account for a typical 10dB deterioration of K_r

With the cable being exposed to a uniform electromagnetic field or to an evenly distributed ground shift, a typical case with CM interference, the shield grounded

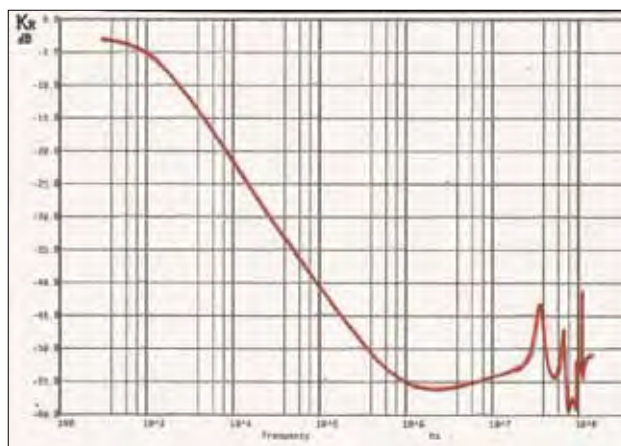

Figure 4. Calculated results for a 5m long single braid coaxial. First $\lambda/2$ resonance is reached around 20MHz.

both ends behaves as a dipole exhibiting self-resonance and anti-resonance for every odd and even multiple of $\lambda/2$, respectively. Accordingly, current peaks will take place periodically for every odd multiple of $\lambda/2$, resulting in a worst-case value of K_r .

*Some tests set-up for measuring K_r are based on end-driving of the cable shield by a 50Ω generator, which introduces also $\lambda/4$ resonances. A quick discussion on this artefact is presented

MuShield[®]

Magnetic Shielding That Works!



- EMI Shielding & Design
- Heat Treatment
- Magnetic Shielding Materials
 - Sheet
 - Coil
 - Seamless Tubing
 - MuMetal2[®]
 - Permalloy[®]
 - HyMU80[®]
- Design Capabilities
- Performance Testing
- Production Capabilities
- Shielding Consultation
- Prototyping
- Manufacturing Capabilities
- Custom Electronic Components Shielding

MuShield is a small company that tackles big problems. Our team is a talented mix of engineers with extensive experience in the field of magnetic shielding. This enables us to build, test, and deliver a product that works within a reasonable time frame. Visit us online at www.mushield.com.

The MuShield Company 9 Ricker Avenue Londonderry, NH 03053 Toll Free: 888.669.3539 Email: info@mushield.com

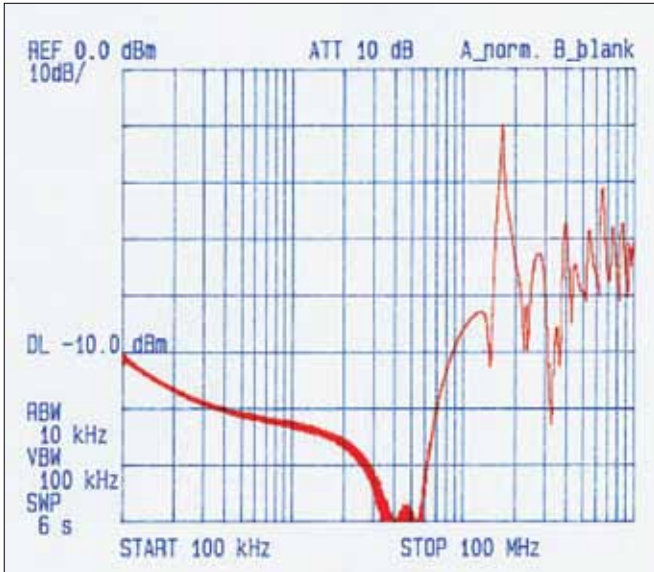

Figure 5. *Kr* for a 5m coaxial, shield grounded with 10cm pigtail (courtesy of AEMC Grenoble, France).

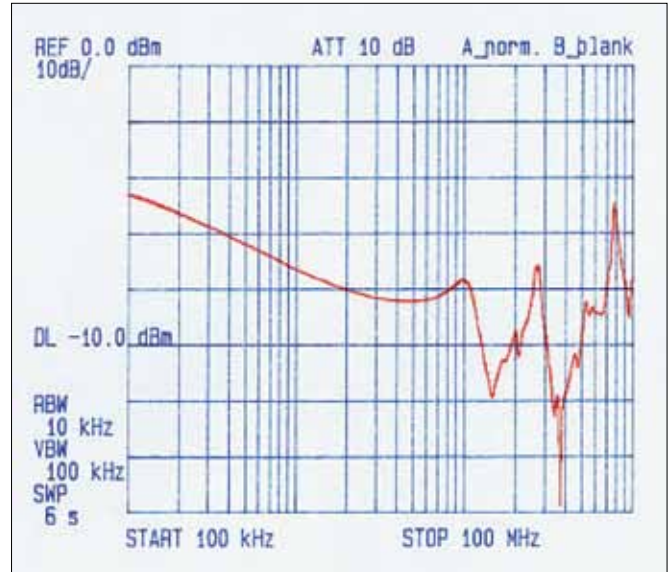

Figure 6. *Kr* for 5m shielded computer cable, with good quality SubD25 shielded connector (courtesy AEMC Grenoble, France)

in Appendix .

One must also take into account C' , the actual propagation speed in the cable-to-ground transmission line, where C' is slower than the ideal free-space velocity C . Typically $C' = 0.7$ to $0.8 C$. Therefore, the actual wavelength in the

cable to ground loop is :

$$\lambda' = 0.7 \text{ to } 0.8 \times \lambda$$

If we align our calculations to the most detrimental conditions, the worst is reached (Figure 3) at the first

FOTOFAB A World Apart In a World of Parts!

Custom Shields and Metal Parts.

Fotofab's process of photochemical etching offers speed, flexibility and precision unmatched by traditional manufacturing methods.

- Print to part in 1 day - yes we're that fast!
- Fotofab's technical staff will drive your project - even without a print.
- Complex features, non-standard sizes and company logos are free.
- Fotofab can form, plate and package your parts...

Just tell us what you need!





You'll see the difference as soon as you talk to us. Contact our sales staff today, or request your free shielding sample kit and design guide at www.fotofab.com/shielding

FOTOFAB

773.463.6211
FAX.463.3387
sales@fotofab.com

3758 W. Belmont Avenue
Chicago, IL 60618
USA

$\lambda/2$ where the received voltage V_d is maximum (due to a current peak) resulting in a low value for K_r . This is translating correctly the actual situation where, for a uniform field exposure, the victim receiver circuit will see a higher interference.

Beyond this first resonance point, for a constant CM excitation, the termination voltage V_d will run through a succession of peaks (at odd multiples of $\lambda/2$) and nulls. Yet, the amplitude of the peaks will not exceed that reached at first resonance.

Simply considering that the length of "electrically active" shield segment is limited to $\lambda/2$, $V_{d_{max}}$ can be predicted as follows:

$$V_{d_{max}} = Z_t (\Omega/m) \times 0.5 \lambda' \times I_{shield} \quad (4)$$

where,

Z_t = transfer impedance at frequency of concern corresponding to λ' . At such frequency, Z_t is dominated by L_t , the shield transfer inductance

λ' = corrected wavelength for propagation speed $C' \approx 0.7$ to 0.8λ

$\lambda' = 0.75 \cdot 300 \cdot 10^6 / F(\text{Hz}) = 220 \cdot 10^6 / F(\text{Hz})$ (average value)

(Eq. 4) for V_d (max) can be rewritten as:

$$V_{d_{max}} = L_t \cdot \omega \cdot 0.5 \cdot (220 \cdot 10^6 / F) \times I_{sh}$$

$$= L_t (H/m) \cdot 2\pi \cdot F \cdot 0.5 \cdot (220 \cdot 10^6 / F) \times I_{sh}$$

Frequency cancels-out in the equation, so reducing

all the variables and using more practical units like L_t in nH/m :

$$V_{d_{max}} \approx L_t (\text{nH/m}) \times 0.7 \times I_{sh} \quad (5)$$

We can furthermore express $I_{sh_{max}}$ for a shield grounded both ends illuminated by a uniform field (typical EMI susceptibility scenario) :

$$I_{sh(\text{max})} = I_{loop(\text{max})} = V_{cm(\text{max})} / Z_c$$

where,

Z_c = characteristic impedance of cable-above-ground transmission line

= 150Ω for a height/diam ratio = 4 (typical of MIL-STD 461 test set-up)

= 300Ω for a height/diam ratio = 50

Thus, Z_c can be given an average value of 210Ω (a +/- 3dB approximation)

Combining Eq. 4 and 5 we get a simple expression for worst case K_r above resonance:

$$K_r (\text{min}) = V_{d_{max}} / V_{cm}$$

$$= (0.7 L_t \cdot V_{cm} / 210) / V_{cm}$$

$$K_r \text{ min (dB)} = -20 \text{ Log} [210 / 0.7 L_t(\text{nH/m})]$$

$$K_r \text{ min (dB)} = -20 \text{ Log} [300 / L_t(\text{nH/m})] \quad (6)$$

A FEW PRACTICAL RESULTS FOR K_r , BELOW AND ABOVE FIRST CABLE RESONANCE

The following figures show some calculations using the formulas of this article, and test results.

One Stop Shop - Build to Print Shielding Solutions

**Next Day Delivery
From Our Catalog**

- Grounding Springs
- ESD Clips
- Connector Gaskets
- Expansion Slot Gaskets
- Board Level Shields
- Full line Standard Product Gasket Catalog

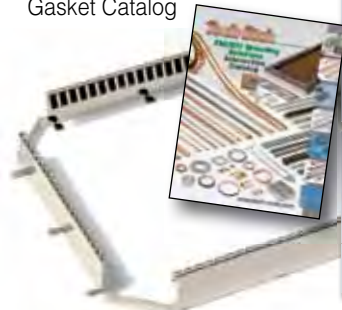

Tech-Etch

Download EMI/RFI Shielding Product Catalog at
www.tech-etch.com/shield

ISO 9001:2008
REGISTERED

TECH-ETCH, INC., 45 Aldrin Road, Plymouth, MA 02360 • TEL 508-747-0300 • FAX 508-746-9639

Figure 4 shows calculated results on a 5m long good quality single braid coaxial cable, 1 meter above ground, with perfect 360° contact at connector backshell. On Figure 5, the curve shows the test results of a 5m coaxial cable where the shield has been intentionally spoiled by a 10cm pigtail. The deterioration of Kr above 8 MHz is spectacular.

APPENDIX

We have seen that when dimension of the cable approaches, or exceeds a half-wave length, the current on the shield follows a sinusoidal distribution with alternating phase reversals every $\lambda/2$ segment. This is complicated by the fact that, if the test set-up is based on a 50 Ω generator driving one end of the shield, this latter appears as a transmission line shorted at the other end, subject to standing waves. This mismatch causes nulls and peaks of current at every multiple of $\lambda/4$.

For the odd multiples like $\lambda/4$, 3

$\lambda/4$, $5\lambda/4$... etc., the null of current correspond to the generator seeing an infinite impedance. While the driving voltage is equal to the open-circuit value, the current minimum on the shield is causing a drop in the terminal voltage Vd, therefore the value of Kr artificially jumps to higher values. This effect is visible on the figures, where Kr appears periodically better, then worse, than its average values. In the present paper, we have preferred to align the calculations on the worst case situation, not the most favorable one.

MICHEL MARDIGUIAN, IEEE Senior Member, graduated electrical engineer BSEE, MSEE, born in Paris, 1941. While working at IBM in France, he started his EMC career in 1974 as the local IBM EMC specialist, having close ties with his US counterparts at IBM/Kingston, USA. From 1976 to 80, he was also the French delegate to the CISPR Working Group, participating to what became CISPR 22, the root document for FCC 15-J and European EN55022. In 1980, he joined Don White Consultants (later re-named

ICT) in Gainesville, Virginia, becoming Director of Training, then VP Engineering. He developed the market of EMC seminars, teaching himself more than 160 classes in the US and worldwide. Established since 1990 as a private consultant in France, teaching EMI / RFI / ESD classes and working on consulting tasks from EMC design to firefighting. One top involvement has been the EMC of the Channel Tunnel, with his British colleagues of Interference Technology International. He has authored eight widely sold handbooks, two books co-authored with Don White and 28 papers presented at IEEE and Zurich EMC Symposia, and various conferences. He is also a semi-professional musician, bandleader of the CLARINET CONNECTION Jazz Group. Contact Mardiguian at m.mardiguian@orange.fr

Would you like to read more about cables, shielding and other electromagnetic compatibility topics? Search *Interference Technology's* archive of technical articles at www.interferencetechnology.com

Dexmet
CORPORATION

Expanding
Technology™

Enhance your Shielding Effectiveness!

Using precision expanded metals can greatly enhance the electromagnetic shielding for your applications and meet EMI/RFI compliance.

However, shielding will react differently depending on its design, degrees of coverage and geometry. They determine how well your shielding attenuates electromagnetic fields.

Let our engineers help you decide on which expanded material best suits your needs and develop a configuration to provide effective shielding for your applications.

Contact Dexmet Today!



Shielding Material for
Aerospace • Electronics • Telecommunications • Industrial

www.dexmetshielding.com / (203) 294-4440

autosplice®
Innovative Interconnections™



**RFI
SHIELD
CLIPS**

- Eliminate EMI/RFI shield post soldering
- Compatible with standard
- high-speed placement
- Permits easy shield removal and
- replacement for rework
- Heights avail from 0.8-4.95mm
- Recommended shield thickness from
- as small as 0.15mm

KEI **KENSINGTON**
ELECTRONICS™
Not just products - Solutions!



For more information, sample kits, spec sheets or pricing visit:

www.keiconn.com OR sales@keiconn.com

800-325-0534

SURGE & TRANSIENTS

Products & Services Index

INTERFERENCE TECHNOLOGY'S 2012 Surge & Transients Products & Services Index contains 20 different categories to help you find the equipment, components, and services you need. Full details of all the suppliers listed within each category can be found in the Company Directory, starting on page 151. The EMC Products & Services Index is presented in its entirety, starting on page 142.

ANTISTATIC COATINGS

Dontech, Inc.
Lamart Corp.
Swift Textile Metalizing LLC

ANTISTATIC MATERIALS

ACL Inc.
Swift Textile Metalizing LLC

ELECTROSTATIC DISCHARGE (ESD) GENERATORS

Advanced Test Equipment Rentals
EM Test USA
EMC Partner AG
Haefely EMC
Noise Laboratory Co., Ltd.

ELECTROSTATIC DISCHARGE (ESD) SIMULATORS

Advanced Test Equipment Rentals
CST of America, Inc.
EM Test USA
EMC Partner AG
Fischer Custom Communications
Haefely EMC
HV Technologies, Inc.
Liberty Labs, Inc.
National Technical Systems
Noise Laboratory Co., Ltd.

EMP SIMULATORS

Advanced Test Equipment Rentals
CST of America, Inc.
EM Test USA
EMC Partner AG
Fischer Custom Communications
HV Technologies, Inc.
Montena Technology sa
National Technical Systems

GROUNDING RODS

Intermark (USA) Inc.

GROUNDING SERVICES

Intermark (USA) Inc.

GROUNDING SYSTEMS

Intermark (USA) Inc.
Lightning Eliminators & Consultants

LIGHTNING GENERATORS

Advanced Test Equipment Rentals
Avalon Test Equipment Corp.
EM Test USA
EMC Partner AG
Fischer Custom Communications
Haefely EMC
HV Technologies, Inc.

Lightning Technologies, Inc.
Noise Laboratory Co., Ltd.

LIGHTNING SIMULATORS

Advanced Test Equipment Rentals
EM Test USA
EMC Partner AG
Fischer Custom Communications
Haefely EMC
HV Technologies, Inc.
Noise Laboratory Co., Ltd.

POWER LINE DISTURBANCE MONITOR

Voltech Instruments Ltd.

POWER LINE ELECTRONICS

Delta Products Corp.

STATIC CONTROL MATERIALS & EQUIPMENT

Advanced Test Equipment Rentals
Swift Textile Metalizing LLC

SUPPRESSORS

ARC Technologies, Inc.
Captor Corp.
Fair-Rite Products Corp.
Fischer Custom Communications
Kemtron Ltd.

SURGE & TRANSIENTS

ACL Staticide
Advanced Test Equipment Rentals
Alltec Corporation
AMS
ARC Technologies, Inc.
Avalon Test Equipment Corp.
CITEL Inc.
EM Test USA
EMC Partner AG
Haefely EMC
HV Technologies, Inc.
Intermark (USA) Inc.
Kikusui America Inc.
L. Gordon Packaging
Liberty Labs, Inc.
MCG Surge Protection
Nextek
Noise Laboratory Co., Ltd.
Okaya Electric America, Inc.
Pearson Electronics, Inc.
Phoenix Contact
RTP Company
Schurter Inc.
Swift Textile Metalizing LLC
Transtector Systems Inc.

SURGE PROTECTION

Alltec Corporation
Bourns Inc.
Captor Corp.

MCG Surge Protection
Metatech Corporation
Phoenix Contact
Schurter Inc.

TRANSIENT DETECTION & MEASURING EQUIPMENT

Advanced Test Equipment Rentals
Circuit Insights LLC
Pearson Electronics, Inc.
Rohde & Schwarz USA, Inc.

TRANSIENT GENERATORS

Advanced Test Equipment Rentals
EM Test USA
EMC Partner AG
Fischer Custom Communications
Haefely EMC
HV Technologies, Inc.
Noise Laboratory Co., Ltd.
Teseq
Transient Specialists, Inc.

TRANSIENT SUPPRESSORS

Captor Corp.
Littlefuse Inc.
TDK-EPC Corp.

UNINTERRUPTED POWER SYSTEM

APC by Schneider Electric

CONDUCTIVE MATERIALS

CONDUCTIVE MATERIALS

3M Electronics Markets
Adhesives Research, Inc.
Alchemetal
Alco Technologies, Inc.
Antistatic Industries of Delaware
ARC Technologies, Inc.
Caprock Mfg.
Cool Polymers, Inc.
Creative Materials, Inc.
Desco Industries Inc.
Device Technologies, Inc.
Dontech, Inc.
EEMCCOIMEX
Eeonyx Corporation
Federal-Mogul Corporation
Intermark (USA) Inc.
Ja-bar Silicone Corporation

Kemtron Ltd.
LGS Technologies
M&C Specialties
Marktek Inc.
Master Bond
MTI - Microsorb Technologies, Inc.
Mueller Corp.
Oak-Mitsui Technologies
P&P Technology Ltd.
Premix Oy
Progressive Fillers International
Sealing Devices Inc.
Sulzer Metco (Canada) Inc.
Swift Textile Metalizing LLC
Tech-Etch, Inc.
THEMIX Plastics, Inc.
Venture Tape Corp.
VTI Vacuum Technologies, Inc.

Find suppliers of conductive adhesives, caulks, epoxies & elastomers, and conductive cloth, coatings, laminates, lubricants, paint, particles, plastics, plating and tapes, in the EMC Products & Services Index, starting on page 142.

Are You Receiving Environmental Test & Design eNews?



Read the latest news —

Stay current with standards
and product updates —

Learn about related events —

etd | environmental
test & design

The interrelationship between electronic products,
systems and devices and their environments

Subscribe online today | etdnews.com

Protecting Security Systems in a Healthcare Facility from Lightning Induced Transients

BRYAN COLE

Technology Research Council
Nichols, New York USA

JIM TIESI

Emerson Network Power Surge Protection
Binghamton, New York USA

A healthcare facility is a multifunctional building or campus that provides health care to citizens and when designated, also provides protection to the population in times of crisis. This includes common functions associated with patient care (e.g. operating rooms, emergency rooms, recovery rooms, etc), but also areas for educational centers, exercise facilities, food service, and other non-patient care activities. Significant amounts of advanced information technology for patient records and accounting functions, laboratories, various imaging systems, (e.g. magnetic resonance imaging (MRI), ultrasounds, x-ray, computerized axial tomography, etc), and security systems are used to meet the mission of a healthcare organization.

Protecting the healthcare facility from environmental conditions is important for service continuity. Lightning is an environmental condition that can cause damage to the facility, the equipment, and rare cases, people. Because of the criticality of the healthcare facility and the risks associated with a lightning protection system (LPS) is required for most U.S. healthcare facilities.

Equipotential bonding is the fundamental principle concept within a LPS.

All components of the facility, including the LPS, the electrical system, the mechanical structure of the facility, and all external components and structures should be effectively bonded to provide a level of immunity from lightning induced transients [1,2,3]. External components include roof top mounted equipment (e.g. HVAC exchangers, communication receivers, etc), and ground level equipment (e.g. security components, parking lights, automatic gates, etc). External structures include remote power stations, remote MRI facilities, and remote security and parking offices.

When a LPS is installed, surge protective devices (SPDs) are required at the service entrance for the electrical distribution system and all communication systems [3]. SPDs are recommended to be deployed throughout the facility in a staged approach [4]. SPDs deployed in a staged or cascade approach have a SPD installed at the service entrance location, SPDs installed at distribution or branch locations, and SPDs installed at point of use equipment. SPDs should be sized in accordance with their location within the lightning protection zone (LPZ) (Figure 1) [1].

HEALTHCARE POWER SYSTEM

The electrical distribution system of a healthcare facility is complex. It is comprised of at least two power sources, power control devices, and separate infrastructure equipment (Figure 2). Normal power is typically provided by the local utility while emergency power is provided by on-

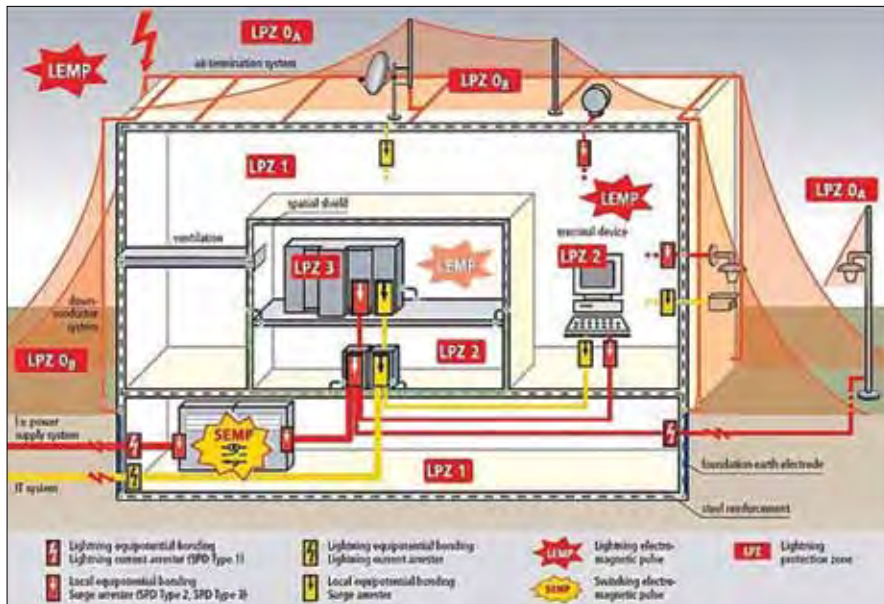

Figure 1. Lightning protection zone concept [1].

site generators [2]. Within the healthcare facility, electrical power is divided between the essential electrical system and the non-essential electrical system. The essential electrical system comprises the equipment system, the life safety branch and the critical branch of the emergency system, and is intended only for those systems intended for life safety [2]. This includes the equipment needed for emergency egress, which includes the security system.

Electrical power provided to the security system is required to be connected to the equipment branch of the essential electrical system in a healthcare facility [2]. When a LPS is installed, SPDs are required to provide protection to the electrical system and critical processes in a staged approach. (Figure 2, Item 1) [4,5]. When the generators are located outside, additional SPDs are needed to provide protection (Figure 2, Item 2) [5]. The cascading of SPDs throughout the facility provides a complete and effective approach to reducing transient overvoltages from affecting equipment and processes.

HEALTHCARE SECURITY SYSTEM

A security system for healthcare facilities can consist of numerous cameras and other detection and monitoring devices (Figure 3). Security systems require operation specific cameras, recording devices, uninterruptible power supplies (UPS) for back-up power, precision HVAC equipment, and SPDs.

The preferred method of recording devices uses stand alone digital video recorders (DVRs). DVRs are commonly provided in rackmount enclosures for ease of connection, ability to maintain required environmental conditions, and overall security. Monitors are provided remotely within the security center.

Connection of cameras to the security center’s DVR(s) can be accomplished by a wired or wireless infrastructure. While the wireless infrastructure is advancing, it is still

hindered by the inability of wireless frequencies to penetrate reinforced structures of a healthcare facility. The preferred connection for security systems is the wired infrastructure, with a growing popularity towards Category 5e and Category 6 infrastructures.

Point of use protection should be provided within the environmental controlled rackmount system. Using a rackmount SPD topology can provide convenient installation of surge protection that will protect the DVR, the environmental system, and any accompanying Ethernet communication systems. Using rackmount topology for Ethernet protection is advisable over discrete devices as it provides easy installation and ensures that all grounds for remote cameras

and other devices are bonded together.

POWERING AND PROTECTING REMOTE CAMERAS

All security cameras require power and communication

HIPOTRONICS

AXOS
COMPACT IMMUNITY TEST SYSTEM



**PERFECTION.
DELIVERED.**

The new AXOS⁵ integrates all of the best features of our stand alone test systems into one single user friendly and economic solution.



www.axos.haefely.com
EMCsales@hipotronics.com

HAEFELY

When it matters...



GORE. Electronic Materials

Enhance performance and increase design flexibility in your electronic systems with the latest EMI shielding and RF grounding solutions from Gore.

gore.com/emi

EMI GASKETS AND GROUNDING PADS

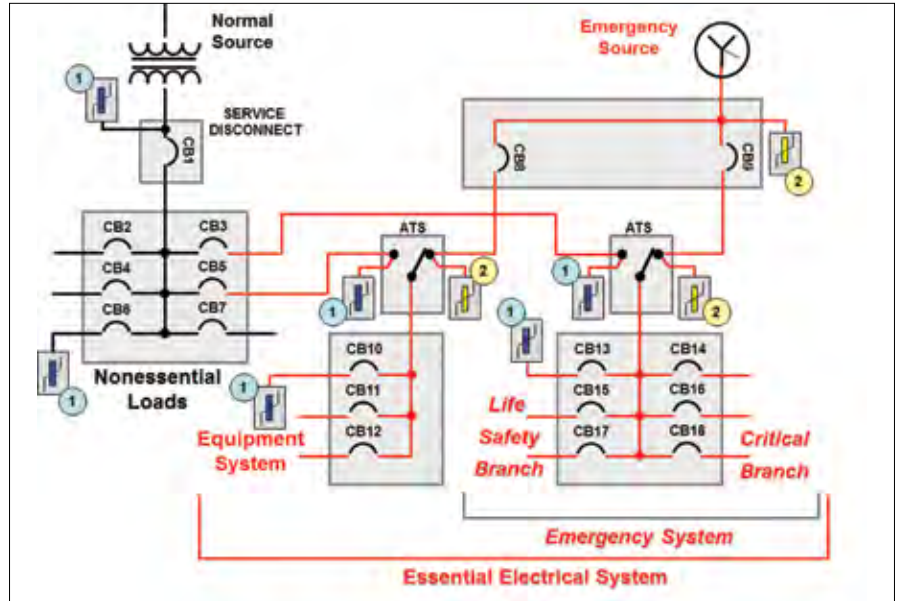

Figure 2. Healthcare AC power system.

circuitry to communicate to the security office. Powering a security camera is achieved with 12 VDC or 24 VDC from an external power supply. The external power supply of security cameras are typically hardwired to the electrical distribution panel as they are more tamper resistant than connecting to NEMA 5-15R receptacles. Video transmission to the security central office and control of the pan, tilt, zoom (PTZ) functions of the camera are accomplished through Ethernet communications.

Protection from lightning induced transients is required on the Ethernet and AC power lines (Figure 5). Security cameras installed in outdoor LPZ0 or indoor LPZ1 environments requires the same level of protection as those installed at the service entrance locations [1]. For AC power SPDs the minimum required surge current handling capability is 20 kA of 8/20 μ s current per mode [3]. Ethernet communication SPDs are required to have a minimum surge current handling capability is 10 kA of 8/20 μ s current per mode [3]. Security cameras installed in indoor applications also need SPDs for protection, but the current handling capability is less demanding.

Protection of the Ethernet sys-

tem can be troublesome if two basic fundamental rules are not followed. First, SPDs are required to attenuate lightning induced transients and allow Ethernet signals to pass without attenuation. Effective lightning transient mitigation for Ethernet systems is best achieved through using hybrid model that incorporates components that are capable of diverting high-energy transients, and components that capable of attenuating or diverting low-energy transients (Figure 6).

Gas discharge tubes (GDT) are effective components for reducing high-energy transients. Additional attenuation of lightning induced transients is achieved by thyristors (CR). When properly designed, positive temperature coefficient (PTC) resistors provide effective isolation between the GDT and the thyristor thereby allowing devices with differing specifications to work in conjunction with each other. PTC resistors are also effective at minimizing transient currents that may be caused by differing ground potentials between the central security office equipment and security cameras. Additional components may be required to ensure that Ethernet signals are not attenuated.

Secondly, if a shielded Ethernet cable is provided, the shield should not connect solidly to ground at the



Figure 3. Overview of a security system.

DVR (source) and the security camera (load). To eliminate circulating ground currents, a solid connection to ground should occur at the DVR, but be isolated at the security camera [6]. The shield of the Ethernet cable can be connected to a ground connection at the security camera if it is achieved through a high-frequency connection (Figure 6). A high-frequency

connection of the shield to ground is accomplished by either a discrete capacitor (C), through the parasitic capacitance of a GDT, or other components.

CONCLUSION

Advanced technology continues to be deployed throughout the health-care system to meet various newly



Figure 4. Rackmounted SPDs.

When failure is not an option...



GORE Wire and Cable

When reliability, durability, and performance can be compromised by harsh environments, GORE® Wire and Cables offer the best solution.

gore.com/electronics

WIRE AND CABLE



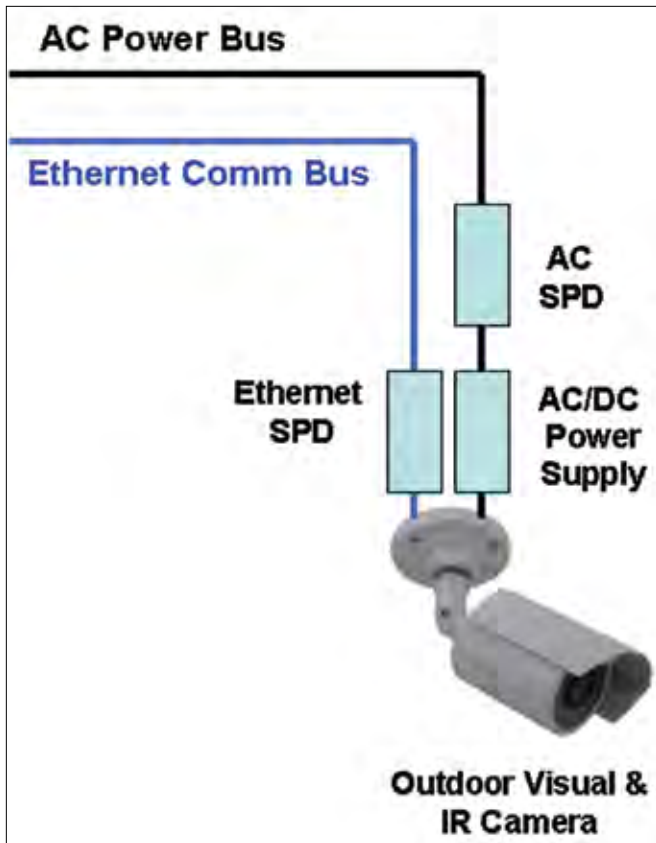

Figure 5. SPD connection at camera.

imposed regulations. Advanced technology is not only used to improve patient outcomes, but also to improve emergency and security systems within the healthcare facility. Security systems are included as a part of the essential electrical system and should be protected from lightning induced transients. The best protection is provided by proper bonding of the system grounds.

Whenever an LPS is installed, SPDs are also needed to provide effective protection against lightning. AC Power SPDs should be installed on the electrical distribution system, and point of use locations. For security systems, AC Power SPDs should be installed on the incoming AC power of the environmentally controlled rackmount system located in the security office. Ethernet SPDs should be installed on all conductors prior entering/exiting the security system enclosure.

At the remote security cameras, AC Power and Ethernet SPDs should also be installed. Hardwired SPDs provide the best protection against tampering. Equip-

ment located in LPZ0 or LPZ1 should be properly rated to provide adequate protection. Ethernet SPDs require design technologies that are capable of providing effective transient protection, but not hindering the quality of the video signals or the communication of the control system designed to move the camera or its lens: pan, tilt, zoom (PTZ) functions. If Ethernet cables with shields are used, the shield should use high-frequency grounding techniques to reduce ground loop currents.

REFERENCES

- [1]. International Electrotechnical Commission (2010), Protection Against Lightning – Part 4: Electrical and electronic systems within structures, IEC 62305-4, Geneva, Switzerland.
- [2]. National Fire Protection Association (2012), National Electric Code, NFPA 70, Quincy, MA USA.
- [3]. National Fire Protection Association (2011), Lightning Protection Systems, NFPA 780, Quincy, MA USA.
- [4]. Institute of Electrical and Electronic Engineers (2006), IEEE Recommended Practice for Powering and Grounding Electronic Equipment, IEEE Std 1100, Piscataway, NJ USA.
- [5]. Cole, B.R. and Tiesi, J. (2009), Properly Applying SPDs in a Healthcare Facility. Interference Technology, Conshohocken, PA USA
- [6]. Hartel, O. (1996). Electromagnetic Compatibility by Design. R&B Enterprises, Conshohocken, PA USA

BRYAN COLE is the President of Technology Research Council. He is a member of IEEE and a number of UL Standard Technical Panels. He has assisted in the development of numerous national and international standards. Bryan can be followed via <http://electricalproductsafety.blogspot.com/>.

JIM TIESI is the Marketing Manager for Emerson Network Power Surge Protection. Jim has 20 years of experience in the design, development, application, and marketing of power quality equipment. He is an active of IEEE, NEMA, and is a member of the Product Development and Management Association. Jim holds a Bachelor of Science degree in Electrical Engineering and a Master's degree in Business Administration.

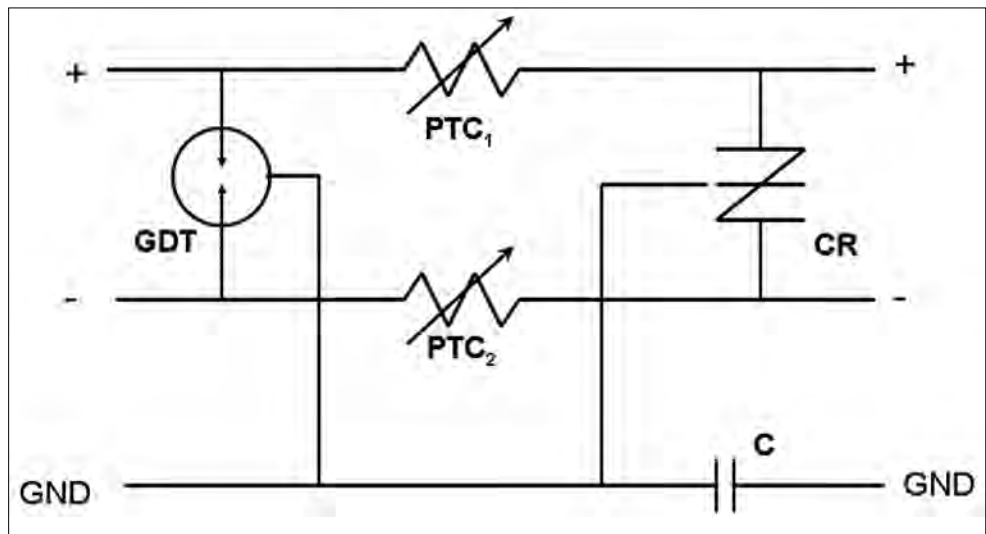

Figure 6. Communication SPDs circuitry.

Avionics Testing Evolution

NICHOLAS WRIGHT

EMC Partner AG
Laufen, Switzerland

Many disturbance sources can affect the correct functioning and therefore the safety of an aircraft. The latest commercial airliner designs include many technological changes that have necessitated a review of avionic system test requirements.

The trend today is to move toward structures made from Carbon Fibre Reinforced Plastic (CFRP) materials that offer all the strength of previous materials but with a significant saving in weight. The last few decades have seen increasing amounts of composite material used in aircraft construction, culminating in the latest designs from Airbus (A350) and Boeing (787). The latter includes over 50% CFRP materials.

In parallel the type and amount of electrical and electronic systems used has also increased dramatically. Some of the latest systems relying on variable frequency power and electrical systems for everything from the galley coffee machine to replacing traditional hydraulic control of the flying surfaces.

The requirement RTCA DO-160 and EUROCAE ED-14 embody many of the tests to be performed on commercial aircraft. Both documents are in fact published under an agreement between the RTCA, EUROCAE and the Society of

Aerospace Engineers so that the content is identical.

All parts of DO-160 are equally important in their own right, but sections 22 and 17 are the focus for this discussion.

Section 22 discusses test requirements for indirect lightning testing of equipment mounted within an aircraft.

Latest generation aircraft require tests to the avionics equipment for which no experience existed. The responsibility is very much on the aircraft manufacturer to ensure that appropriate testing is performed. DO-160 / ED-14 remains the base for these tests, but separate standards are emerging for specific aircraft types with requirements to take account of construction, materials and amount of electronics.

INDIRECT LIGHTNING REQUIREMENTS

DO-160 / ED-14 section 22 defines a series of waveforms that represent impulse energy entering an aircraft and being induced into cable bundles within the structure. This can occur through resistive coupling or via induced E and H fields. Based on many decades of experience, six waveforms have been defined and are applied as damage assessment (PIN Injection) with fixed test system impedances or cable and ground injection disturbance (Single Stroke, Multiple Stroke & Multiple Burst) tests.

Cable bundle and ground injection tests specify a Test level (voltage of current) that should be achieved in the cable. This

Standard	PIN Injection	Test Process	Cable Bundle	Test Verification
DO-160 / ED-14	V_{OC} / I_{SH}	System calibrated applied to EUT	V_T / I_L or I_T / V_L	Voltage & Current Test and Limit values must be monitored during test process
Boeing	V_{OC} / I_{SH}	System calibrated applied to EUT	V_T / I_L only	I_L can exceed specified value to achieve V_T in test cable. Levels must be monitored during test process
Airbus	V_{OC} / I_{SH}	System calibrated applied to EUT	V_{OC} / I_{SH}	After calibration no monitoring required

Table 1. Comparing test methods.

is coupled with a Limit level for either current or voltage. Waveforms are defined as having a predominately voltage form (WF2, 3, 4), current form (WF1, 3, 5A, 5B, 6) or a hybrid form (WF3). This latter can be defined in terms of either voltage or current.

There is no definition of test equipment impedance and the cable bundle impedance can have a significant influence on the test result.

To take account of changes in designs, aircraft manufacturers are basing their requirements on the principles in DO-160 but with some deviations.

WHAT DOES THIS MEAN FOR THE TEST EQUIPMENT AND THE TEST ENGINEER?

The DO-160 / ED-14 method requires constant monitoring of the impulses as the test signal is increased to the desired level. This is labour intensive and there is a risk that the cable impedance could prevent either the TEST or LIMIT level from being reached.

This situation requires a further test process and much more time. As these test types can already run for many days or even weeks, a further extension is undesirable.

Boeing test requirements set a Voltage level that should be reached in the cable, even if it means exceeding the current limit. This is still dependant on the cable impedance and may necessitate changing test equipment.

Airbus has arrived at a solution that is independent of cable impedance and in fact in line with most international impulse standards. The test system (generator, coupler and cables) is calibrated with fixed impedance as for PIN injection. After calibration, the test can be performed without monitoring impulse levels in the cable bundle.

A hybrid generator is a circuit design where the dynamic behavior is well known. The impulse waveform is specified in open circuit and again in short circuit. The advantage of this design is that independent of the load impedance (e.g. cable length, aluminium or carbon fibre structure) the test results are repeatable and comparable. A hybrid solution is the only generator design that gives comparable test results over the complete EUT load range.

VOLTAGE SPIKE REQUIREMENTS

The DO-160 / ED-14 section 17 specifies requirements for voltage spikes in an aircraft power system. There have always been voltage spikes transmitted around system

cabling in aircraft. In modern times, increasing complexity of electronic systems and the advent of full computer control of platforms has meant that voltage spikes need to be addressed at a whole different level to the past. Aircraft contain many sources that can „generate“ voltage spikes. The most likely source of voltage spikes are electric motors. All motors are inductors fitted in the power line. Energy is stored in the inductors magnetic field and when power is removed, is released as a spike with amplitude proportional to the inductor and therefore the motor size. In modern platforms there is a tendency to add more and more motors to automate certain functions. Aircraft have huge motors for flap and landing gear actuation. Because of the motor size, spikes can attain many times the nominal voltage level.

The phenomenon is fairly well known and many standards already exist, however, with the increasing technological challenges, existing ideas need to be challenged and revised where necessary. In particular the use of “fly-by-wire” technology requires a new level of immunity to voltage spikes to ensure aircraft safety.

REQUIREMENTS

DO-160 and ED-14 are identical and in section 17 address the voltage spike test requirements. The “classic” 2/10us impulse is used with a generator impedance of 50ohm to test AC and DC systems.

The latest edition of Airbus ABD0100.1.8 specifies test-

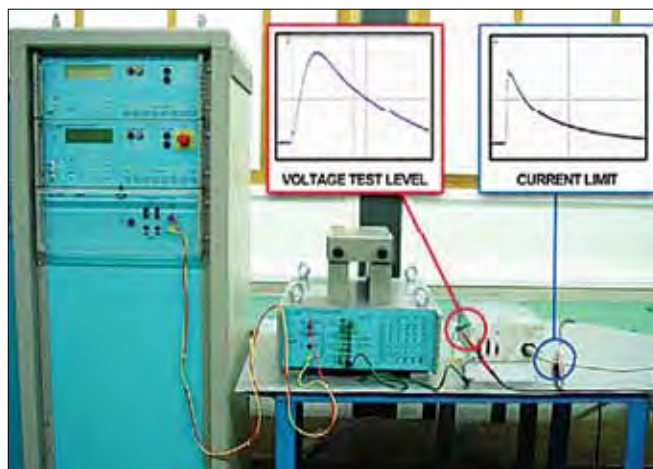

Figure 1. Indirect lightning setup.

Standard	Title	Voltage Spike Test
RTCA DO160	Environmental Conditions and Test Procedures for Airborne Equipment	Section 17
EUROCAE ED14	Environmental Conditions and Test Procedures for Airborne Equipment	Section 17
AIRBUS AMD-24C	Test conditions for voltage spikes	
AIRBUS ABD0100.1.8	Electrical and Installation Requirements	

Table 2. Voltage spikes from different perspectives.

ing requirements for the A350XWB aircraft. It is tailored specifically to include the experience gained by Airbus over many decades. The voltage spike tests included in this document, were originally proposed as specification AMD-24 C intended for the A400M military transport aircraft and A380 double decker. Based on the 2/10us impulse, this requirement adds a further 4 waveforms. The 2/50us, 2/100us, 2/200us and 2/400us. As pulse width increases, the test amplitude reduces. The intent is to inject higher energy levels into EUT cables, thus improving on the basic DO160/ED14 requirements. In order to achieve this aim, the generator impedance is reduced to 50ohm for all pulses except the 2/10us, this remains at 50ohm. There is a logical explanation for reducing the impedance. Power supplies tend to have very low impedances, so to transfer maximum energy from the generator into the cable the two should, ideally, be matched.

The longer impulses generate more energy at lower frequencies. A generator with high output impedance feeding a low impedance load will burn energy internally rather than transfer it to the load. The 2µs rise-time generates frequencies (at the 3dB point) of approximately 200kHz, so the majority of the energy is at lower frequencies.

In all cases, DO-160, ED-14 and ABD0100.1.8, specify injection on cable bundles only. The preferred application method in all cases is SERIAL injection. This requires the impulse to be coupled into the EUT cable bundle using an inductive coupling clamp. Serial injection is most widely used due to the non-intrusive nature of the coupling. The type of coupler used must have the correct bandwidth to accurately transmit the impulse and not saturate when AC or DC power from the EUT is passed through it.

For power line coupling, there would be a tendency

for impulse energy to flow into the low impedance power supply rather than the EUT. This is often overlooked but is simply addressed by inclusion of a 10µF capacitor fitted between phase and neutral or phase to phase for 3-phase supplies. This adds a high impedance block for the impulse energy, directing it to the EUT.

A common thread running through the various standards is the need to superimpose the impulse on all lines simultaneously. What does this mean? Should every cable attached to an EUT be subjected to the impulse at the same time, or does this requirement refer to a all the wires in a single cable bundle. The diagram in DO160 / EUROCAE which shows the testing one cable at a time.

However, ABD0100.1.8 does request SIMULTANEOUS testing on ALL CABLES containing power lines connected to any one EUT. This is logical as voltage spikes circulating in a system will impinge on all power interfaces simultaneously.

CONCLUSION

Safety of airliners and the travelling public is paramount. To maintain the current high standard as technology evolves, there is a need to re-think test requirements.

NICHOLAS WRIGHT was educated at Worcester College, England. He has worked on military projects for the UK M.O.D., Marconi and GEC Avionics. Moving into the field of EMC, he has held posts as product manager and regional sales manager, culminating in his current position as international sales manager for EMC Partner based in Switzerland.

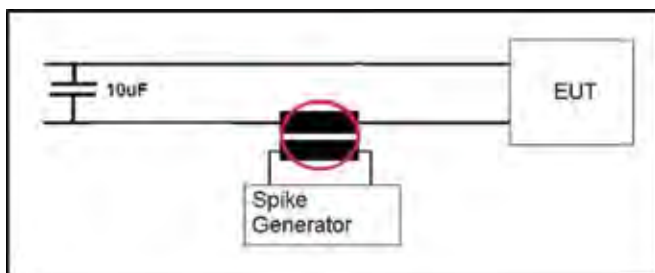

Figure 2. Voltage spike serial injection.



Figure 3. Voltage spike test system.

Fundamentals of EMC Design: Our Products Are Trying To Help Us

KEITH ARMSTRONG

Cherry Clough Consultants
Stafford, United Kingdom

1. INTRODUCTION

We often design electronic products only to find that when we test them for electromagnetic compatibility (EMC), their emissions and/or immunity are not as good as we need them to be.

Usually, at this time, we feel as if we are fighting against the laws of physics to contain the conducted and radiated emissions, or to reduce susceptibility.

But in fact the laws of physics – Maxwell’s Equations – are causing our design to have the best emissions and immunity that the physical structure allows. We might say that our product is doing the very best it can to reduce its emissions and improve its immunity!

(I am using the word “product” to mean every type of electronic assembly, from modules, subsystems, equipment and systems, to installations.)

The key issue – is that all currents (including strays) always flow in closed loops, and always take the path of least impedance, whether this path is along conductors or through the air (or other dielectrics) between them.

Current flows in the path of least impedance to minimize the energy in its associated electric and magnetic fields, rather like the way a drop of water in air assumes a

globular shape to minimize the energy in its surface tension.

Because currents naturally take the paths that result in the lowest EM field energies, they automatically give us the best emissions and immunity of which our design is capable. Rather than fighting the laws of physics, what we are fighting is our own lack of understanding of how the laws of physics work. Once we understand this we can work with these laws from the start of our design, to easily and quickly create cost-effective products that meet their EMC specifications.

Unfortunately, the way that Maxwell’s Equations are taught doesn’t show how easy it is to derive (*without* any mathematics!) the easiest, simplest, most profitable way to design products using good EMC engineering techniques [1].

Signal Integrity (SI) and Power Integrity (PI) are subsets of EMC engineering, so employing good EMC design techniques from the start of a new project ensures excellent SI and PI (see [2]).

This has the effect of considerably reducing the number of design iterations, generally reducing overall cost of manufacture, and reducing time-to-market.

Time-to-market has, since 2000, become the most important issue for a financially successful electronic product. This is shown by the industry responses to Question 6 in [3], see Figure 1, and I have seen other reports from similar prestigious organizations that show the same for most electronic applications.



CST STUDIO SUITE 2012

Discover what happens...

Making Sense of the Real World – System Level EM Simulation

Components don't exist in electromagnetic isolation. They influence their neighbors' performance. They are affected by the enclosure or structure around them. They are susceptible to outside influences. With System Assembly and Modeling, CST STUDIO SUITE 2012 helps optimize component as well as system performance.

Get the big picture of what's really going on. Ensure your product and components perform in the toughest of environments.

Choose CST STUDIO SUITE 2012 – complete technology for 3D EM.



CHANGING THE STANDARDS

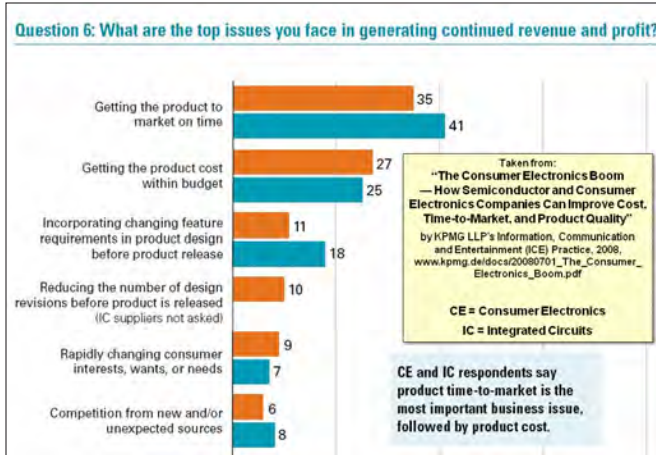

Figure 1. Time-to-market and cost.

It is often found in practice that employing good EMC design techniques from the start of a project improves functional performance, sometimes even giving signal quality and functional specifications better than anything that had ever been achieved before.

Unfortunately, some project/engineering managers insist on the lowest Bill Of Materials (BOM) cost, believing that this will somehow lead to the most profitable product.

Where it prevents us from working *with* the laws of physics, we often find ourselves fighting this ill-advised and plainly incorrect approach (see [4]). The result is a number of additional delays and cost-increases (e.g. adding filtering and shielding to pass EMC tests) that increase the overall cost-of-manufacture, delay market introduction, reduce profitability and increase financial risks.

For example, the ideal printed circuit board (PCB) layer stack for good EMC design of a given product might have eight layers, but the minimum SI and functional specifications can be met with just six. The cost-saving achieved by using the six-layer board is considerably outweighed by the extra delay and cost of adding filtering and shielding at the end of the project to meet its EMC specifications.

The *overall cost of manufacture* ends up being much higher than would have been achieved with an eight-layer PCB, and the (more important) time-to-market is delayed by several weeks – which in some situations can make the difference between a product’s success and its failure.

This article briefly introduces the laws of physics as they apply to our products’ SI, PI and EMC design issues, developing an “EM Design Toolkit”. It then briefly describes applying that toolkit to a PCB assembly example.

I wrote a similar type of article on applying these same laws of physics to ease the EMC design of systems and installations or any size, [5], which might be of interest to some readers.

2. EXTERNAL AND INTERNAL EMC

Apart from DC issues such as the fan-out of DC signals or the voltage drop caused by resistance in DC power conductors, all SI and PI issues are just subsets of EMC, as Figure 2 tries to show (also see [2]). They might be called “internal

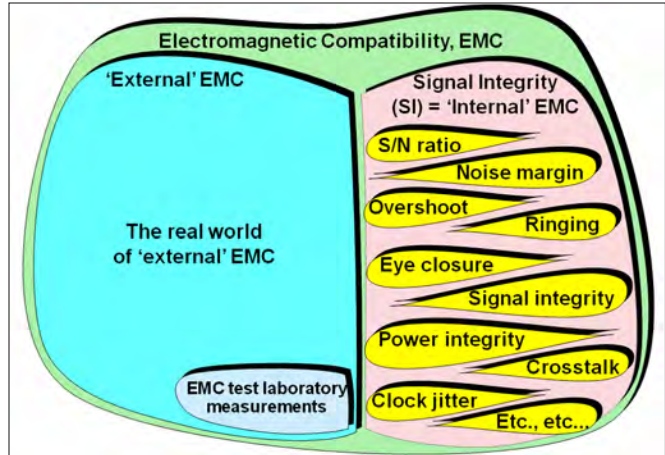

Figure 2. Good EMC design also takes care of SI and PI.

EMC” – the product interfering with itself. For more detail on this, see Chapter 8 of [6] or 2.10 of [7].

3. EVERYTHING HAS PERMEABILITY (μ) AND PERMITTIVITY (ϵ)

All media and materials in this universe have conductivity, permeability (μ) and permittivity (ϵ).

$$\begin{aligned} \text{In vacuum (and air): } \mu_0 &= 4\pi 10^{-7} \text{ Henries/meter} \\ \epsilon_0 &= (1/36\pi) 10^{-9} \text{ Farads/meter} \end{aligned}$$

Other media and materials are characterized by their relative permeability (μ_R) and permittivity (ϵ_R) – dimensionless numbers, just multipliers for the vacuum permeability and permittivity – so their overall permeability is: $\mu_0\mu_R$ and their overall permittivity is: $\epsilon_0\epsilon_R$

Permeability is associated with inductive EM energy, which we draw as magnetic field contour lines.

Permittivity is associated with capacitive EM energy, which we draw as electric field contour lines.

Conductivity (and its reciprocal, resistivity) is associated with energy loss, i.e. the conversion of EM energy (magnetic or electric) into thermal energy.

The shape and size of conductive structures carrying current, and the $\mu_0\mu_R$ and $\epsilon_0\epsilon_R$ of the media or materials they are embedded in, cause inductance (L) and capacitance (C), respectively.

This means that *whenever* there is a fluctuating voltage (V) there is *always* an associated current (I).

And vice-versa: *whenever* there is a fluctuating current (I) there is *always* an associated voltage (V).

Some digital designers assume that because the input resistance of a CMOS gate is several M Ω , PCB traces carrying digital signal voltages carry no (or a very tiny) current. This is incorrect because it ignores the inevitable (and unavoidable) stray capacitance of the traces and the gate input.

For example, with a gate input capacitance of 3pF and a 3 Volt digital signal rise-time of 300ps (quite slow these days) the peak current required just to charge up this single input gate alone is about 30mA. This intense current “spike” must flow in a loop that includes the DC power supply distribution network, so can cause all manner of SI, PI and

Covering a broad spectrum of your EMC simulation requirements

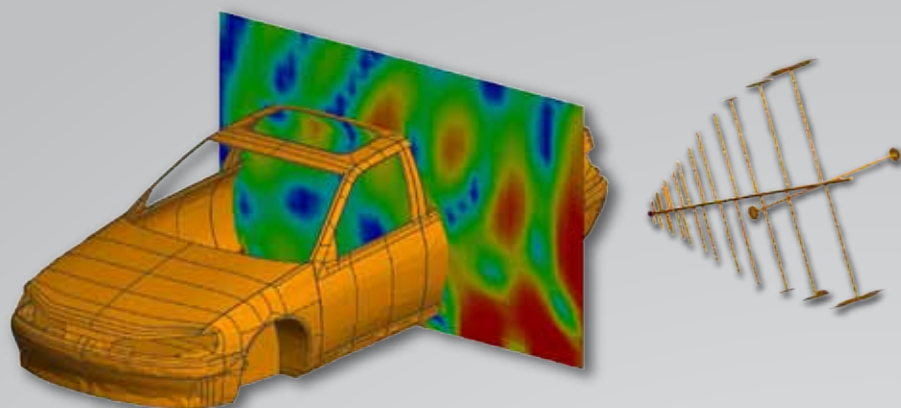

FEKO includes several computational methods, each optimised for different problem types, and hybridised for the efficient analysis of complex, low and high frequency problems. Special formulations, tools and interfaces are used for EMC analysis:

- shielding • coupling • cable analysis
- radiation • irradiation • near-fields
- fast frequency sweep • combined field and network analysis
- specific absorption rate (SAR) • test system design and analysis.

Additional Applications

Antenna Design, Antenna Placement, Waveguide, RF Components, Microstrip Circuits, Radomes, RCS, Bio-EM.

FEKO
Comprehensive Electromagnetic Solutions

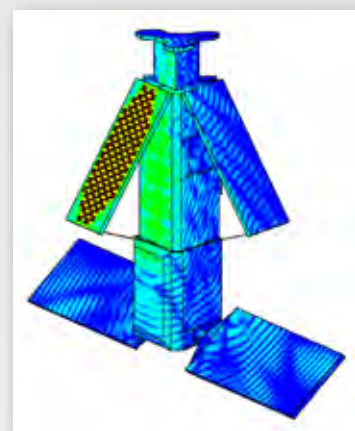
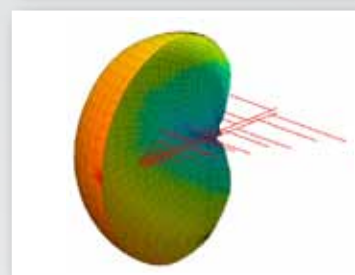
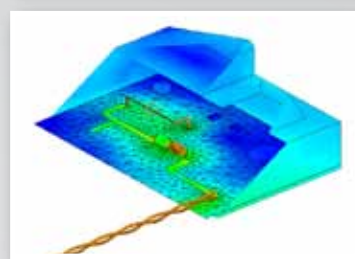
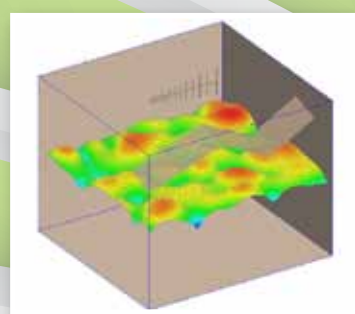

www.feko.info

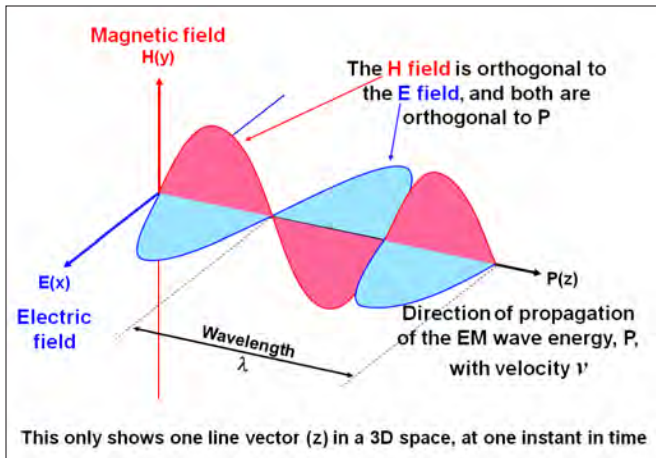

Figure 3. Visualizing a linearly-polarized EM wave in free space.

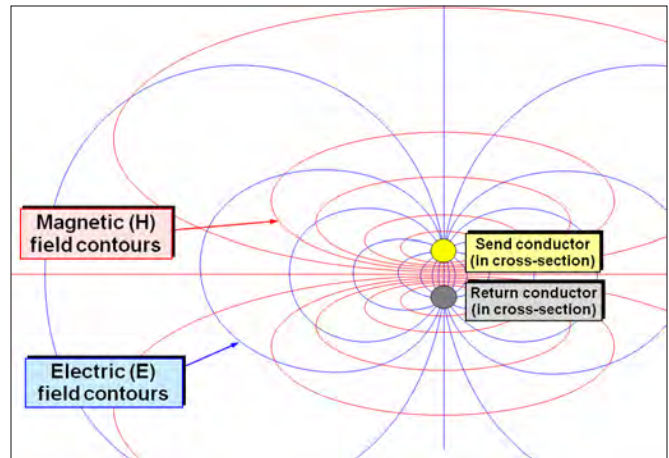

Figure 4. Cross section of fields associated with a pair of send/return conductors.

EMC problems.

In insulators and dielectrics (e.g. air, PVC, fiberglass) $\mu_0\mu_R$ and $\epsilon_0\epsilon_R$ cause analogous effects to inductance and capacitance – so *whenever* there is a fluctuating electric field (E) there is *always* an associated magnetic field (H).

And vice-versa: *whenever* there is a fluctuating magnetic field (H) there is *always* an associated electric field (E).

Chapter 2 of [6] and 2.3 of [7] have more details on the above.

4. BECAUSE OF MAXWELL'S EQUATIONS...

Every fluctuating voltage or current is really EM power (Watts, i.e. rate of flow of electrical energy), propagating as a wave in the medium with velocity $v = 1/\sqrt{(\mu_0\mu_R\epsilon_0\epsilon_R)}$ m/s (≈ 3.108 m/s in air or vacuum) and creating electromagnetic (EM) fields as it does so.

This applies to *every* kind of electrical event, whether we call it electrical power; electronic or radio signals; infra-red; light; lightning, etc., and including all mains 60Hz power; analogue, digital and switch-mode power and signals; data communications; radio-frequencies (RF) and microwaves, etc., including all electrical, electronic, or radio “noises”.

Figure 3 is an attempt at visualizing a single vector of an EM wave at a single frequency, as it propagates in free space. It shows that the E and H fields are perpendicular to each other, and that they both fluctuate in directions perpendicular to the direction in which the EM power is propagating.

The usual analogy is with waves on the ocean, which propagate wave energy across the surface of the ocean even though the molecules of seawater in a wave only move up and down.

A common way of visualizing the E and H fields associated with voltages and currents in conductors, is shown in Figure 4, for a send/return pair of conductors shown in cross section. E-field lines always terminate on conductors, perpendicular to their surface, and H-field lines never terminate on anything.

These lines should be considered like contour lines on

a geographical map – they are not real, but their density (number of lines per inch) indicates the strength of the field (like the slope of a hill). So we can see that the E and H field strengths are highest in between the send and return conductors.

The electrical power associated with the current in the wires propagates along the length of the wires. Because Figure 4 shows the wires in cross section, the electrical power (i.e. propagating EM energy) is flowing perpendicular to the surface of the page or screen with which you are reading these words, and the E and H fields it sketches are fluctuating in the plane of the paper or screen.

Maxwell’s famous four equations include Amperes Law, which says that currents always flow in closed loops, and Faraday’s Law of electromagnetic induction, which says that currents always flow in such a way as to minimize their loop areas.

Maxwell himself invented the concept of displacement current, showing how a fluctuating current could flow through capacitance even though there was no conductive path for it.

5. BECAUSE OF THE LAW OF CONSERVATION OF ENERGY...

Ignoring the virtual particles in the “quantum vacuum”, [8], there is always zero EM power at any point in space. The EM power entering a point must be exactly balanced by the EM power leaving it.

This is Kirchoff’s current law, which is often described as: “the sum of the currents at any point equals zero”, and is equivalent to Ampere’s Law.

Another way of putting this is to say that all currents flow in closed loops. If some current could escape from a loop and go wandering off on its own, never to return, then at the point where it left the main loop there would be an imbalance in the current. Current would accumulate at that point, and the Law of Conservation of Energy tells us this can’t happen (in our universe, anyway).

So we see that Conservation of Energy (in this context

sometimes called the Law of Conservation of Charge) means we could rewrite Kirchoff's current law as: "the sum of the EM power at any point equals zero".

This means that at any circuit node that sends a current (whether power, signals, noise, etc.) also simultaneously emits an antiphase current that we call the return current.

These send and return currents propagate through the impedances of the various media (air, conductors, etc.), eventually meeting up to create what we think of as send/return current loops. At any instant in time, the currents in the send and return current paths balance each other out.

Notice that because all power, signal and (stray) noise currents, of any kind, flow in closed loops, this means that the connection to the safety earth/ground electrodes generally has no relevance at all for good SI, PI or EMC design.

(In poor EMC designs, stray current loops can travel through the safety earth/ground, using it as a convenient conductive structure, and causing high levels of emissions and poor immunity.)

6. BUT IT'S REALLY ALL BECAUSE OF QUANTUM ELECTRODYNAMICS (QED)

How did the return currents "know" what paths to follow to exactly match up with their respective send currents? Prof Feynman's slim book, [9], says that propagating EM energy (light is also EM energy) takes the path of least time – which is also the path of least energy – which is also the path that gives the best SI, PI and EMC possible for a given geometry and media/materials (although this last conclusion is not found in [9]).

To find out how propagating EM energy "knows" to do this, we have to integrate over the whole of space and time, including negative time. This was Prof Feynman's great insight, which made the world of quantum electrodynamics amenable to calculation, and is responsible for much of modern electronic technologies.

But when Prof Feynman's students asked him what underpinned this natural behavior, he said no one knew and there was simply no point in even asking the question. It was just the way nature worked. However, some progress is now being made in answering this question, with the favored solutions being the "many worlds" or "parallel universes" theory, which is known to be true because otherwise quantum computers wouldn't work.

A characteristic of QED is that it defies common sense and destroys the time relationship between cause and effect, with some outcomes that can seem very weird. Apparently, with sensitive enough instruments listeners could hear what the outcome of a ball game would be by listening to radio broadcasts from the future! Unfortunately it only reaches a few femtoseconds into the future – not enough time to place a winning bet.

Also, QED permits the power budget for a point to deviate from zero for a few femtoseconds, but after that the Law of Conservation of Energy insists that the power books have to balance to zero once again, as described

in 5 above.

Maxwell's Equations and related laws of physics describe a common-sense, cause-and-effect world in which understanding basic concepts makes it quite easy and quick to design low-overall-cost good SI, PI and EMC – but the QED concepts that underpin this are very weird and wonderful.

Despite its weirdness, QED is the most well-proven theory ever known, and has been proven to be accurate to about 11 orders of magnitude more than has (so far) been possible for gravity.

Happily, for all SI, PI and EMC work, engineers need go no deeper than Maxwell's Equations and Conservation of Energy (or Charge).

7. WHAT DOES ALL THE ABOVE MEAN FOR SI, PI AND EMC?

7.1 EM power divides between alternate paths according to their admittances

In the "far field" of an EM source, E and H fields experience the "wave impedance" of the media or materials their EM power is propagating through:

in air or vacuum: $\sqrt{(\mu_0/\epsilon_0)}=120\pi\Omega$ (near enough 377 Ω)
in other media (e.g. PVC, oil, fiberglass, etc.):
 $120\pi\sqrt{(\mu_R/\epsilon_R)}\Omega$

Shielding & Gasketing for every need

- ▶ VTI provides EMI shielding and gasketing for a host of applications across multiple industries, from medical to aerospace instruments:
 - Medical, Electronic, Defense/Government, Electrical, Aerospace, Industrial
- ▶ EMI/RFI/ESD shielding for plastic electronic enclosures
- ▶ Solutions for design engineers
- ▶ Form-In-Place (FIP) gaskets for conductive/environmental sealing on plastic or metal components



The leading vacuum metallizing provider for RFI and EMI shielding

Request a free sample today!
Call 800.482.1941 or
Email VTIsales@vactecinc.com

A Veteran Owned Small Business
ISO 9001:2008 Certified
Quality Management System
ITAR Compliant



VTI VACUUM TECHNOLOGIES INC.

1215 Industrial Ave., Reedsburg, WI 53959 T 608-524-9822 F 608-524-9722

www.vactecinc.com





These simple wave impedance formulae are only true in the “far field”, typical for radio transmission and reception, whereas in the “near field” the impedance situation is more complex, and the dominant effects on the impedance of a path through the air or other dielectric are inductive and capacitive coupling – often called “stray” or “parasitic” inductance and capacitance. See Chapter 2.4 of [6] or 2.3.3 of [7], for more on this, including how to calculate whether we are in the near or far field.

For EM waves propagating along conductive structures (what we call power, signals or stray currents flowing in cables and PCB traces), the medium surrounding them has an important effect on impedance, but so does the shape of the structures carrying the current and the shape and proximity of nearby conductors – most especially the return conductor(s), but any other conductors in the near field will also have an effect.

So EM waves propagating along conductors can experience impedances that are lower, or higher, than the impedance of the medium surrounding them.

This means that for a fluctuating current travelling along a conductor there are always alternative paths in the air and other dielectrics, so its send/return current loop is never a simple one.

In fact, all currents always split and flow in multiple alternative paths, in proportions according to the admittances of each of the paths (a path’s admittance is the reciprocal of its impedance).

This is conceptually no different from the way that a DC current flowing through a bunch of parallel resistors will divide up according to their various conductances (reciprocal of their resistances) – with the highest current flowing in the resistance with the lowest value (i.e. the highest conductance).

The big difference for fluctuating currents is what is sometimes called “the invisible schematic” – the impedances of the stray capacitances and inductances, which are alternative paths for EM energy to flow in, which successful practical EMC engineers learn to visualize whenever they look at conductive structures.

Each part of a current loop has several alternative paths. The paths can be along conductors or through components and devices, or through the stray paths in the insulation, PCB substrate, air, etc.

It simply doesn’t matter to a propagating EM wave. The conductors, components and devices that we designed, and the stray capacitive/inductive coupling and “accidental antenna” emissions (see 7.2) that we didn’t design and not wanted (but can’t be prevented entirely) all just look like different admittances (reciprocals of their impedances).

For example, a significant portion of the EM wave power might leave a conductor and continue on its path by travelling through the air – for example as a (capacitive, E-field) displacement current – if it sees that air path as having impedance comparable with that of the conductor.

When a conductor resonates (i.e. is not a well-matched-impedance transmission line, see 7.6) in a way that creates

a high impedance, a “stray capacitance” path through the air can easily create a lower loop impedance, causing *most* of the current to travel as displacement currents.

And where an air path resonates in a way that creates a low impedance, it could easily create a path with much less loop impedance than that of the intended conductors, so once again most of the current can travel as E-field displacement currents in the air.

We could say that our main task of SI, PI and/or EMC designers is to reduce the proportion of the EM waves (wanted currents) that “leak out” of our conductors – “escaping” into nearby conductors via stray capacitance and inductance (what we call crosstalk), and also “escaping” into the air as far-field EM waves (what we call EM emissions and measured with antennas in test labs).

It is important to understand that every current loop, however formed, with however many branching current paths going wherever, *always has to* return *exactly* 100% of the EM energy back to its source, to comply with the law of conservation of energy.

Actually, the reality of power and signal propagation is not that a current starts off from a voltage source and eventually returns back to it – having flowed around a loop or loops – but that the send and return currents are actually generated simultaneously by the source, and balance each other out at every instant thereafter.

Anyway, this perspective that current flows in multiple paths according to their admittances, shows that – to achieve good SI, PI and/or EMC – all we need to do is control the impedances in the various paths that are available to our wanted signals or power currents, so that they travel predominantly in the loops we want them to.

For example, if it was possible to design so that no signal or power current was “lost” to alternative paths, then we must have no crosstalk, no emissions, and – as a direct result – our product’s SI and PI must be perfect and its EM emissions zero (see [2]). Also, by the Principle of Reciprocity (see 7.2 below), its RF immunity would be perfect.

Of course, perfection is never achieved but we can get close enough to reduce emissions to sufficiently small amounts, and improve immunity by as much as is needed, without adding significantly to the overall cost of manufacture, simply by working *with* the laws of physics.

For more detail on this topic, see Chapter 2 of [6], 2.3 of [7] or 10.1.4 in [10].

7.2 All conductors are “accidental antennas”

A transmitting antenna is merely a conductor that *intentionally* leaks its voltages and currents as EM power into the air. A receiving antenna is simply a conductor that *intentionally* picks up voltages and currents from the EM fields around it.

Of course, the more usual situation is that we don’t want our conductors to transmit (leak) some of their EM power, or pick up noise from the environment. EMC engineers usually call the fact that they always do leak and pick-up: “accidental antenna behavior” or “unintentional

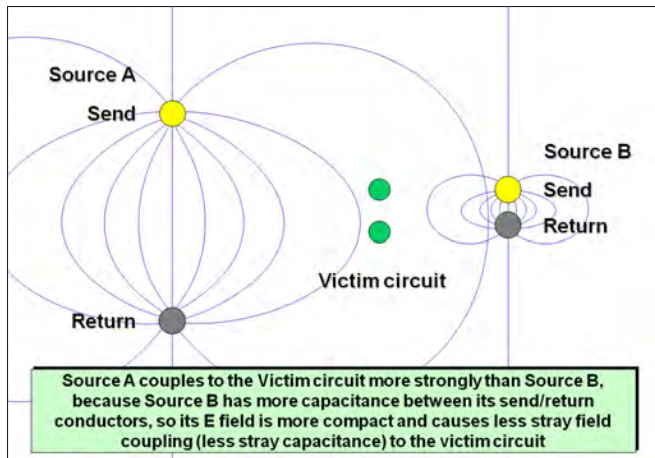

Figure 5. Example of E-field coupling.

antenna behavior”.

When a conductor is exposed to E, H or EM waves propagating in its insulating medium (e.g. the air), its electrical/electronic circuit experiences the same voltage and current noise that we would need to create if we wanted to generate the exact same field pattern at the conductors. This is called the *Principle of Reciprocity*.

The Principle of Reciprocity also applies to accidental antennas, so when a conductor carrying a current has imperfect control of the wanted current loop that results in noise emissions, it will suffer noise pick-up from its EM environment in exactly the same way.

When electronic engineers are discussing SI or PI, they usually call accidental antenna behavior crosstalk, and they notice that the same techniques that reduce the noise coupled from the crosstalk’s “aggressor” or source also help reduce the noise picked up by the crosstalk’s “victim” – another example of the Principle of Reciprocity.

7.3 Current loop size and coupling

The transfer of EM power from one conductive circuit to another – whether intentional or not – is called EM coupling. It can be described by “coupling coefficients” which are (of course) frequency dependent because they represent stray capacitance and inductance.

Up to the first resonant frequency, the larger the area of the send/return current path’s total loop, the larger its impedance, the smaller its admittance, and the larger its E and H field patterns and hence its coupling with other conductors.

As shown in Figures 5 for E-fields and Figure 6 for H-fields (and Figure 10, see later) the larger the current loop, the higher is the proportion of its wanted current that couples with (leaks into) “victim” circuits, causing higher levels of noise currents flowing in unwanted loops, increasing the waveform distortion in wanted signals, and worsening emissions and immunity.

Figures 5 and 6 show us that it is important to minimize the send/return current loop areas, for all circuits – whether they are accidental transmitters or receivers of

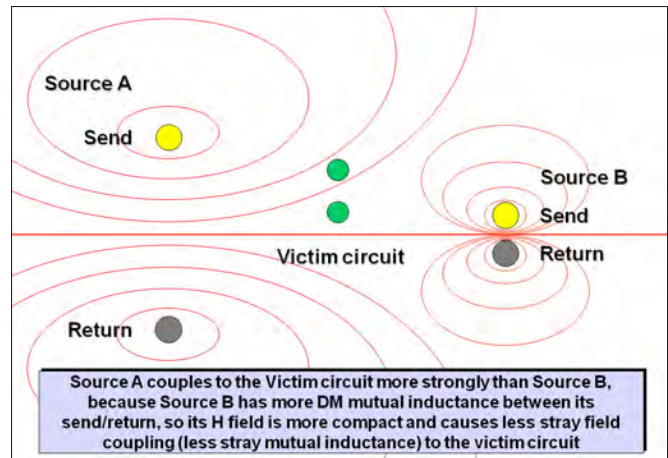

Figure 6. Example of H-field coupling.

EM noise – to maximize their SI, PI and EMC. For more detail on this, see Chapter 5 of [6], 2.7 of [7] or 10.1 of [10].

7.4 All currents (including strays) naturally take the path of least impedance

The fact that currents naturally “prefer” to flow in the path with the smallest loop area and lowest impedance (described in 6 above) is the only way that I know of where the laws of physics work *with* SI, PI and EMC designers, instead of against us.

Computer field solvers show this phenomenon very clearly. Figures 7 and 8 are copied from [11], and show that when a bent wire carrying a current is routed close to a sheet metal chassis that it is using as a return path, the return current flows almost exclusively in the metal that lies underneath the wire, following its bent path, at frequencies above about 1kHz.

This is because the return path in the metal sheet below the bent wire creates the current loop area with the lowest possible overall impedance for that structure, even though the return current has to go around a bend to achieve it.

The red dotted lines in Figure 8 were drawn by the authors of [11] to help readers understand where the mean or average current return paths lie, because the EM field solver simply provides color gradients.

Notice that above 1kHz, although the return current is flowing in part of the metal sheet, the rest of the sheet is “quiet” – i.e. it has no currents flowing in it and so no voltage drops across it.

Circuits using those quiet parts of the sheet for their current return paths (e.g. as their 0V plane) do not suffer any voltage noises from the bent wire’s return currents. (At 100Hz and below the impedance of the sheet is so low that the voltage noise caused in the other circuits by the now-widely-spreading return current are generally negligible).

This is a very important result that shows that we can have many different segregated areas of circuits (e.g. digital, analogue, switch-mode, etc.) sharing the same 0V plane (which I will start to call the RF Reference in 8 below) without their “ground noise” currents causing crosstalk or interference between the areas. See Chapter 7 of [7] and all of [12] for more detail on using this fact to help achieve low-cost SI, PI

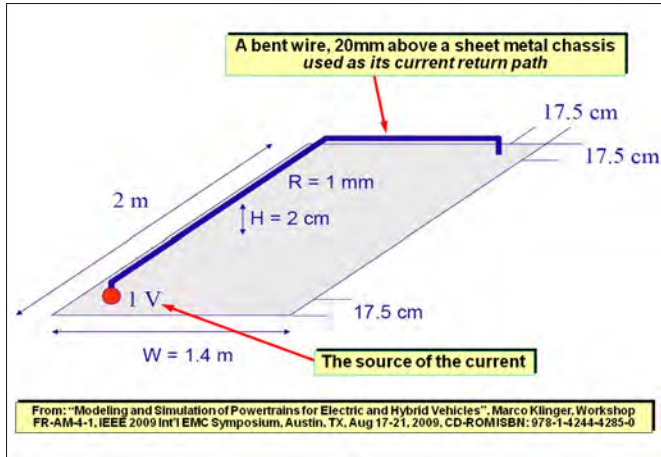

Figure 7. Example of a bent wire with a sheet metal chassis for its return current.

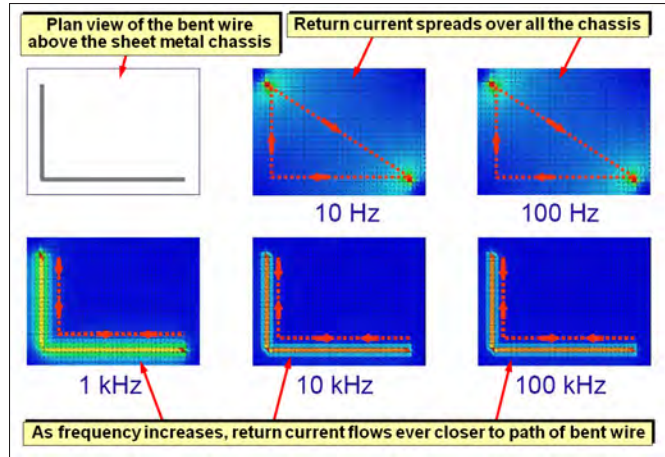

Figure 8. Computer simulations of the return current path for a wire above a plane.

and EMC.

I have seen this sort of simulation done many times, with wire-over-sheet structures like Figure 7 or with PCB traces over planes (e.g. slides 46-50 in [13]), and I have also seen it done as practical demonstrations using close-field probes. The results are the same, up to however many GHz one cares to go.

7.5 Power and signals in conductors have two modes of wave propagation

Differential Mode, DM (also called transverse or metallic mode) is what we call our “wanted” power and signals.

Common Mode, CM (also known as “longitudinal mode” or “antenna mode”) is caused by the stray, leaked, “unwanted” EM energy when a DM loop’s near-field E or H fields meet another conductor, as shown in Figures 5 and 6. It also occurs when far-field EM waves couple power from the wanted signal in its intended circuit, to another circuit – accidental radio transmission and reception.

Figure 9 shows the relative paths of the DM and CM currents in a simplified system.

Paraphrasing 7.1 above – the electricity does not all stay in the wire!

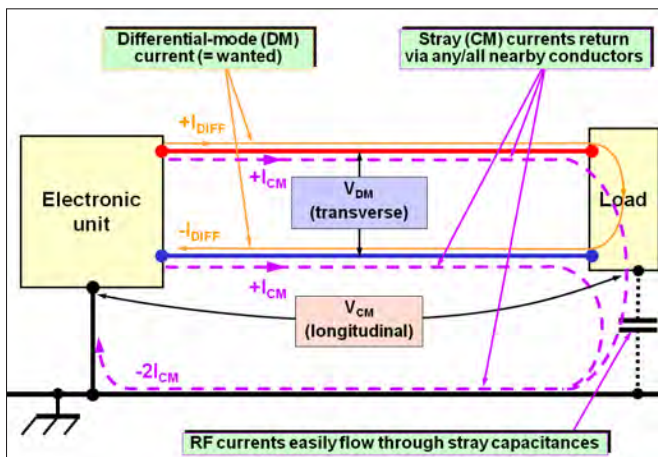

Figure 9. An example of DM (wanted) signals causing CM noises, for a ‘floating’ load.

Some of it travels as stray CM currents, which – like all currents – must flow in closed loops.

Because CM loops are generally very much larger than the DM loops that caused them, their E and H field patterns are much more widely spread. The result that CM is generally the major cause of “accidental antenna” effects causing EM problems for emissions and immunity over the frequency range from 1MHz to 1GHz.

Figure 10 shows that CM currents also couple with “victim” circuits through H-field coupling, similar to how DM currents couple (in Figure 6).

Reducing the size of the CM loop reduces its H-field coupling into the victim, in the same way that reducing the size of the DM loop does in Figure 6. And reducing the size of the CM current loop also reduces the amount of E-field coupling into the victim, in the same way as for the DM E-field in Figure 5.

So, just as it is important for good SI, PI and EMC to minimize the area enclosed by all wanted (DM) current loops, it is also important for all unwanted, accidental, CM current loops. For more detail on this topic, see Chapter 5.5 of [6], 2.7.5 of [7] or 10.1.5 of [10].

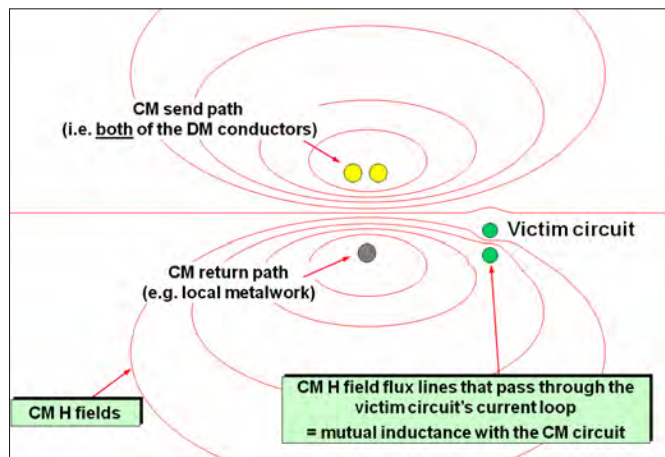

Figure 10. Example of CM H-field coupling.

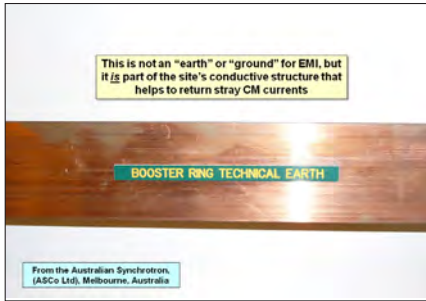

Figure 11. This copper busbar is not an “earth” or “ground” for SI, PI or EMI.



Figure 12. These are not “earths” or “grounds” for SI, PI or EMI either.



Figure 13. ... these are also not “earths” or “grounds” for SI, PI or EMI.



Figure 14. ... and neither are these “earths” or “grounds” for SI, PI or EMI.

7.6 Resonating conductors make perfect accidental antennas

There are various causes of resonances in conductive structures, at certain frequencies...

- a) When the L and C reactances happen to be equal
- b) Due to geometry interacting with wavelength

The second item concerns transmission-line matching. When mismatched conductor characteristic impedances cause propagating waves to be reflected, under certain conditions and at certain frequencies they can cause standing waves to arise, which are a type of resonance.

At resonant frequencies, loop impedances fluctuate wildly, in the range between the conductor's series resistance (possibly just a few mΩ), up to the stray shunt resistance (possibly a few MΩ).

Accidental antenna effects (stray couplings, whether near-field or far-field) are significantly amplified by resonances, often between 10 and 100 times (20 to 40dB), possibly more, affecting both emissions and immunity equally due to the Principle of Reciprocity.

7.7 There is no such thing as “earth” or “ground” for SI, PI and EMC

Currents always flow in closed loops. So the idea that the earth/ground electrodes provide a perfect zero-impedance sink that we can use to absorb, or otherwise make unwanted electrical power, signals or noises go away, can't possibly be true – it is a total myth, pure and simple, having no basis in reality in this universe. [13] has more on this, especially its slides 32, 33 and 79.

Even if a zero-impedance earth/ground *could* exist (which it can't, because everything has impedance) – if we sent some unwanted current into it, the current would come back via some other route to complete its loop. So, then: no current sinks (in this universe).

Earth/ground is only a valid concept (can only have any effect) for

human safety, where it is an issue of preventing electric shock by limiting the maximum potential differences that someone could come into contact with, whether they are caused by mains electricity leakage currents or faults, or lightning strokes.

Even when earth/ground electrodes are doing their thing for safety reasons, the relevant currents still flow in closed loops.

Figures 11 through 14 show some examples of what are commonly called earths or grounds, but are really just elements of a product's, equipment's, building's or site's conductive structures that help return CM currents back to their sources. Whether these structures are connected to safety earth/ground electrodes, or not, is of no consequence for SI, PI or EMC.

Of course, I am not the first person to comment on the meaninglessness of the term earth or ground for SI, PI and EMC. Dr Bruce Archambeault is an IBM Distinguished Engineer and a mainstay of the IEEE EMC Society, and many years ago he produced the graphic copied in Figure 15, as a way of making the same point, but in a more amusing way, see [13].

Because it is natural to assume that something called “earth” or “ground” is an infinite sink for noise currents – even though such a thing simply cannot exist – the use of such words or their graphical symbols encourages incorrect design for SI, PI and EMC, and I have seen millions of dollars have been wasted over the years for this exact reason.

So I always *strongly recommend* that the words “earth” or “ground” and their graphical symbols are *never used in electronic design* (except when a safety earth or ground is actually intended – and then for electrical safety purposes only). Instead, call the conductive structures by other names that mean what they say, e.g. RF Reference (see 8 below), CM Return Path, or whatever.

Using words such as “chassis”, “frame”, “enclosure”, “shield” or “Faraday Cage” can also lead to the same conceptual design errors as “earth”

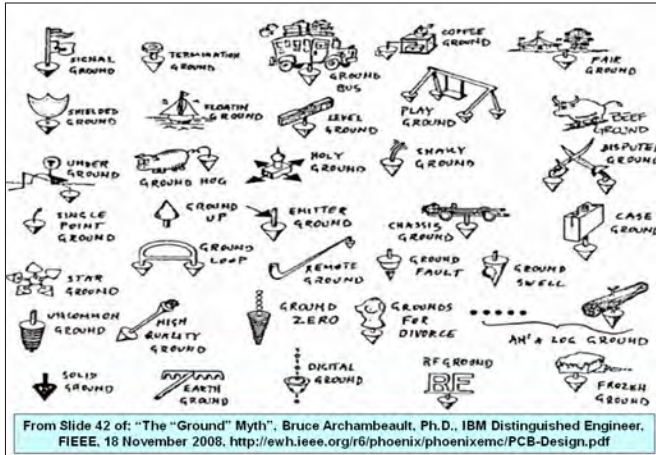

Figure 15. “Ground” is meaningless for SI and EMC.

or “ground” – so it is important to be very careful to only use them to mean what they actually are (i.e. mechanical structures made of metal) rather than assume they are (mythical) infinite sinks for noise currents.

For more detail on this, see 5.7 of [6] or 2.7.7 of [7], also 11.1.2 and 11.1.3 of [10].

8. APPLYING THESE “EM DESIGN TOOLS” TO A REAL-LIFE PCB ASSEMBLY

8.1 Introduction to the example

Sections 2 to 7 above have given us a set of EM design tools – really just mental concepts for how the EM energy that we call our power and signals actually prefers to flow to maximize SI, PI and EMC.

Notice that in sections 2 through 7 I intentionally used very little math; it is not necessary for an understanding of these important concepts. In fact, using equations can obscure what is really going on, which every successful EMC designer learns to “see” with his/her “mind’s eye” just by looking at the conductive structure of a product.

With the complexity of modern products it is best for the designer to understand the concepts and have “the eye” for them, leaving the calculations to the appropriate types of EM field solvers.

Anyway, now for a real-life example – controlling the EM emissions and immunity of the typical electronic product sketched in Figure 16.

To minimize the overall cost of manufacture, this PCB assembly should have good EMC characteristics, so that a lot of money and time does not have to be spent (and add weight and size) by shielding and filtering it to get it to pass its EMC tests.

Because our EM design tools are all concerned with controlling EM field patterns to minimize unwanted “noise” coupling, the exact same tools also improve immunity (e.g. maximizing immunity to nearby walkie-talkies, cellphones, GPRS, 3G, Wi-Fi and Bluetooth transmitters, and also transients, ESD and lightning).

The assumptions made in the initial design of the ex-

ample were not in accordance with the “Laws of Physics Based EM Design Tools” outlined in 2 through 7 above. Instead, they represent what are unfortunately still commonplace bad practices in many electronic product design departments.

One bad practice used in our example is the use of so-called “single-point earthing/grounding” (sometimes called “star earthing/grounding”), using 0V plane splits between (and on) the PCBs. This is *assumed* to keep devices’ circulating return currents confined to certain circuit areas, preventing crosstalk of noise between them (e.g. digital noise in analogue) – but it only works well below a few tens of kHz.

Splitting 0V planes ignores the fact that fluctuating currents *always* divide up according to the admittances of the various alternative paths, including “stray” paths through the air or insulation (see 7.1 above). For this reason, since 1980, the author has always found that when microprocessors and switch-mode converters are used, single-point earthing/grounding has always been a bad design practice for SI, PI and EMC. Others will no doubt be able to give examples from before 1980.

Another bad design practice used in the example is the assumption that achieving the lowest BOM cost is sufficient to produce the most profitable product. So the number of board layers and amount of power decoupling was reduced to the minimum that achieved the functional specifications. Also, provision has not been made for fitting EMI filters to all of the cable connections, because this would have increased the board’s area.

Section 1 mentioned that relying on achieving the lowest BOM cost to create profitable products has been known to be an incorrect practice since 2000. Plain common sense easily reveals the fallacy inherent in this overly-simplistic approach – we only have to consider a product that had a BOM cost that was half (or less) of that of all its competitors – but suffered a 100% warranty return rate. Clearly, this would not be a successful product, so there is very much more to a product’s profitability than its BOM cost.

I see many designs like the example in Figure 16 every

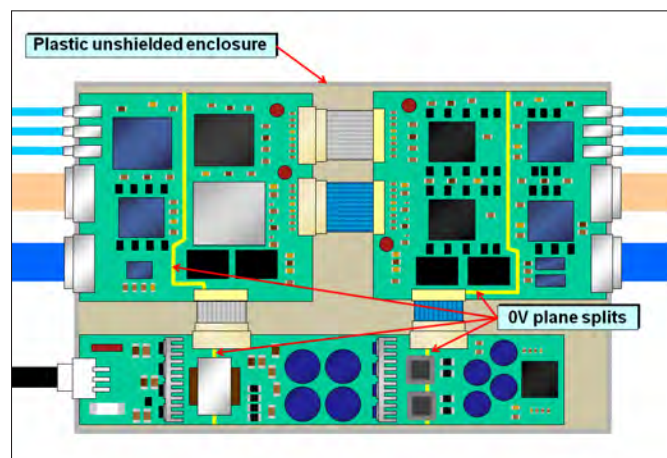

Figure 16. Overview of the example PCB assembly.

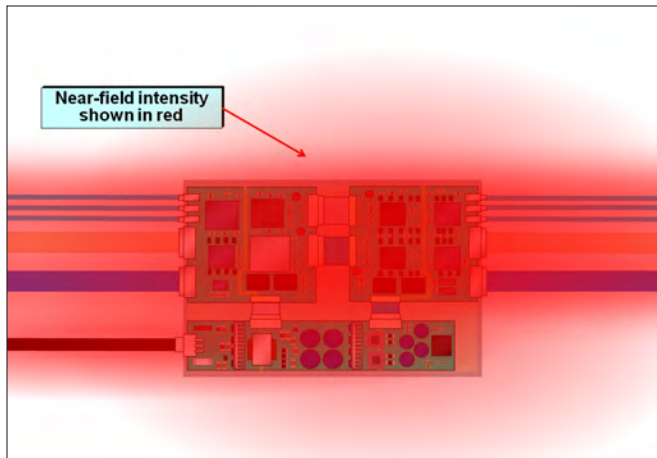

Figure 17. Near-field plot of the example (simulated, or measured with near-field probes).

year. They all suffer poor functional performance at first, especially poor signal-to-noise (S/N) ratios and unreliable software that take many design iterations to solve, causing project delays, increasing costs and reducing profitability.

Once the functional problems are solved, they then fail their EMC tests, requiring many *more* design iterations to solve, causing more delays and more project costs, plus requiring the addition of filters and shielding that increase BOM cost, weight and size and reduce profitability even more. They also suffer higher-than-hoped-for warranty return rates, which erode profitability even more.

A plot of the near-field emissions 20mm above the PCB assembly, at the stage where it meets its functional specifications but has not yet been tested for EMC, is shown in Figure 17.

What do such near-fields mean? This close to the PCB and its components they are the wanted DM signals, plus DM and CM crosstalk and noise. High levels mean reduced S/N ratios in analogue circuits, and reduced noise margins in digital circuits – leading to unreliable software.

In EMC testing, high levels of near-fields over large areas indicate high levels of conducted and radiated emissions, and correspondingly poor conducted and radiated immunity.

In real life, high levels of near-fields over large areas means a lower proportion of satisfied customers (increasing the cost of future sales, because it is easier to sell products that customers like), and higher levels of warranty costs. All causing lower profitability.

We understand, from the laws of physics discussed in sections 2 through 7, that:

- all currents (including DM and CM “noise” currents) flow in closed loops
- current loop shape and area govern field patterns
- currents naturally “prefer” to flow in the loops that have the lowest impedance – hence the smallest field patterns and best internal and external EMC.

So we can see how to make a number of improvements

to the circuit design and PCB layout, to reduce the areas of the DM and CM current loops and make their near fields more compact.

8.2 Improvement #1: Create an RF Reference

We replace the multiple PCBs, with a single PCB that has a common conductor (almost always a 0V plane) over its entire area, which I shall call the RF Reference. You may choose your own name for it, as long as it is not “earth” or “ground”.

The RF Reference in a PCB is at least one solid, continuous, copper plane layer, which lies underneath – and extends well beyond – all devices, components, traces and power plane areas.

There should be no traces “snuck into” this plane layer, and any gaps in it must be unavoidable and as small as possible.

Cellphone designers found that their products’ close proximity between 2 Watt UHF or microwave RF transmitters, microphone amplifiers and digital processors meant that even the clearances around via holes added too much impedance to their RF Reference planes, so developed microvia PCB manufacturing technology (also called “High Density Interconnect” or HDI, or “Build Up”) that provides 100% solid copper RF Reference planes.

An RF Reference achieves very low impedance (Z), the value of which depends on the devices and the EMC requirements specification to be met – but it must always be $\ll 1\Omega$ over the frequency range that must be controlled to avoid causing/suffering EMI.

“The frequency range that must be controlled to avoid causing/suffering EMI” is all of the DM frequencies created in the devices on the PCB, and all of the frequencies existing in the operational environment and/or in the immunity test standards (if they require immunity over a larger frequency range).

Designing a profitable product is all about satisfying customers whilst selling a legal product at an overall profit, and there can be many more EMI requirements involved in satisfying customers than merely passing the minimum requirements of the minimum set of EMC test standards required for legal sales.

The point of creating an RF Reference is that it automatically provides a low-impedance (high-admittance) return path for all possible power/signal/noise currents, and CM noise currents on the PCB. Because it is in very close proximity to the PCB’s components, devices and traces, all these current loop areas are small – just what we need for good SI, PI and EMC.

It is important to realize that we don’t have to “make” the return currents flow in the RF Reference and so have the least E and H field emissions – we only have to provide an RF Reference plane and they will naturally “prefer” to flow in it rather than elsewhere! (See Figures 7 and 8). The RF Reference plane works best with lower-profile components, so we also replace any tall components and devices with ones that lie close to the PCB and its RF Reference plane layer(s).

See Chapter 7.4 of [7], 3 and 4 of [12] and 11.2.2 of [10] for more detail on creating effective low-impedance RF Reference Planes in PCBs.

8.3 Improvement #2: Decoupling the DC supplies

We design the decoupling between DC power rails and the RF Reference to achieve low Z , the value of which (as for 8.1) depends on the devices and the EMC requirements specification to be met – but must always be $\ll 1\Omega$ over the frequency range that must be controlled to avoid causing/suffering EMI.

This permits the fluctuating DM currents in the power rails to flow in much smaller loops very close to the devices that cause them – which they naturally “prefer” to do, rather than flowing more widely in the RF Reference – making small areas of DM near-fields that create less CM noise emissions than larger areas would.

PC motherboards now need to achieve power supply impedances of much less than $0.25\text{ m}\Omega$ to frequencies much more than 1GHz. This is impossible to achieve with low-cost decoupling capacitors, because above about 300MHz they are beyond their self-resonant frequency and so act inductively – their impedance rises with frequency – making low-enough impedances impossible.

However, because we now have a RF Reference plane in the PCB, we can pair it with adjacent power planes to provide distributed decoupling capacitances within the PCB’s fiberglass dielectric, which can maintain very low impedances up to any number of GHz.

See Chapter 7.5 of [7], 5 of [12] and 12.1.3 of [10] for details on how to do effective decoupling on PCBs.

8.4 Improvement #3: Cable filtering

We add direct bonds or filters to the RF Reference on all traces connected to off-PCB conductors, whatever their electrical/electronic/other purpose (including metal mechanical parts; and metal hydraulic/ pneumatic pipes, etc.).

Filters on inputs can often be just a capacitor connected to the RF Reference, but filters on outputs will generally need a series resistor or soft-ferrite choke so that adding the capacitor to the RF Reference does not significantly increase the peak output current.

Of course, we might need to make more complex filters by combining capacitors with resistors and/or soft-ferrite chokes and/or CM chokes – but there are far too many details involved to even start to address this topic in this article. For more details on filtering, see Chapter 5 of [7], 2 of [12] or 13.2 of [10].

These direct bonds or filters are placed where the traces connect to the off-board conductors, to provide low- Z paths for CM currents that would otherwise “leak” from the PCB into the conductors. As for 8.1, the values of Z that are required depends on the devices and the EMC requirement specification, but must always be $\ll 1\Omega$ over the frequency range that must be controlled to avoid causing/suffering EMI.

8.5 Improvement #4: Using matched transmission lines

Where device data sheets specify the use of matched transmission-lines – usually for high-speed clocks or serial data lines – designers almost always remember to control their trace geometry and matching impedances.

But they generally do not consider treating all of the other traces as matched transmission lines, until they are investigating digital signal over/undershoots, ringing or other unwanted noises that cause incorrect or unstable software operation late in a project – the stage where delays and design changes are most costly.

These over/undershoots or ringing are indications of strong emissions (and poor immunity at the emission frequencies), as shown in [2]. Suppressing them to get good EMC, either by filtering at their drivers or by using matched transmission lines to reduce “accidental antenna” effects and prevent resonances, results in very low over/undershoots and no ringing. It also reduces crosstalk and makes (bug-free!) software work very reliably indeed.

EMC textbooks often make recommendations about when to treat a PCB trace or cable as a matched transmission line, but digital device rise- and fall-times are now generally so short (typically $< 0.5\text{ns}$ for 74-series glue logic and $< 0.2\text{ns}$ for microprocessors and memories) that almost all practical trace and cable lengths now need either to be filtered to significantly reduce their frequency content, or else be treated as matched-impedance transmission lines.

See Chapters 4.7 and 7.6 of [7] and 6 of [12] for more on designing with matched transmission lines.

8.6 The improved example

The appearance of the example PCB improved by 8.2 through 8.5 above, is shown in Figure 18. Notice that it still has one plane split, under the mains safety isolation transformer – which cannot be avoided.

Despite increasing the number of board layers to provide RF Reference and Power Supply planes, and additional planes for controlling transmission-line impedances, and despite increasing the number of decoupling capacitors and filters, it is quite normal to find that the overall cost of manufacture (not the BOM) is lower. This is because the inter-board connectors and their cables have been removed – significant causes of assembly errors and rework; unreliability and warranty returns.

Figure 19 shows the near-field plot 20mm above the improved PCB assembly, which now has only small red areas around the components. These are almost entirely the DM fields associated with the wanted power and signals, which we cannot eliminate without eliminating the power or signals themselves.

Remember, all fluctuating currents (whether power, signals or noise) are really EM energy propagating as waves, so the best we can do is provide structures that allow these currents to naturally flow in loops of low impedance (high admittance) so that they naturally create

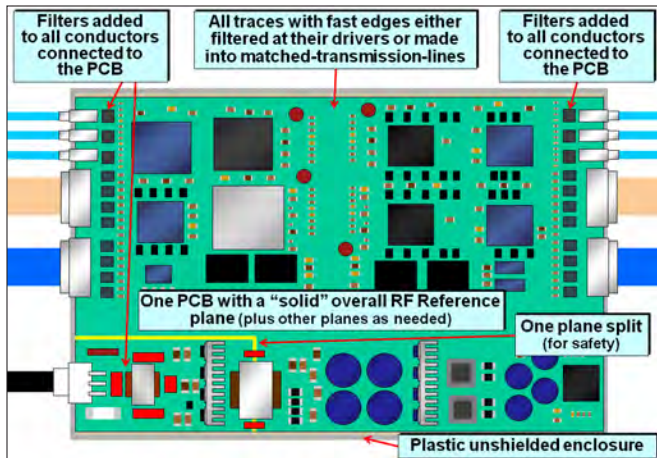

Figure 18. The improved example PCB assembly.

very small and local field patterns, with great benefits for SI, PI and EMC. When we have achieved this, as shown in Figure 19, we see very little field-spreading is seen due to CM noise currents.

8.7 Improving by using cable shielding

Where the use of filtering and unshielded cable techniques (Chapter 4.4 of [7], 2 of [12] and 13.1.8 of [10]) could not suppress the DM or CM fields around a cable by enough, shielding might be necessary for some (or all) cables and/or parts of (or the whole) PCB assembly.

9. CONCLUSIONS

All electrical and electronic activities are really EM energies travelling as propagating waves, and connecting to safety earth/ground has no effect on them so is unimportant and unnecessary for SI, PI and EMC.

We can easily design circuits and PCBs to create small, low-Z current loops for both the wanted DM and the stray CM currents, the EM waves naturally prefer to flow in these routes. So, by working *with* the laws of physics, we automatically achieve very compact field patterns, which are best for internal and external EMC and financial success.

Because these techniques control field patterns to minimize unwanted “noise” coupling, because of the principle or reciprocity the exact same techniques also minimize susceptibility, for example minimizing unwanted “noise” couplings.

The principles of good design techniques for SI, PI and EMC are very clear, easy to understand, and easy for everyone to implement at low cost in practice. Products really are doing their best to help us pass EMC tests and meet EMC requirement specifications – all we need to do is give them a little help, from the start of their design process.

10. REFERENCES

- [1]. Armstrong, K. “Key knowledge for the efficient design of electronic products and their EMC – that we were never taught at university”, Keith Armstrong, ANSYS Seminar “Next Generation Signal Integrity

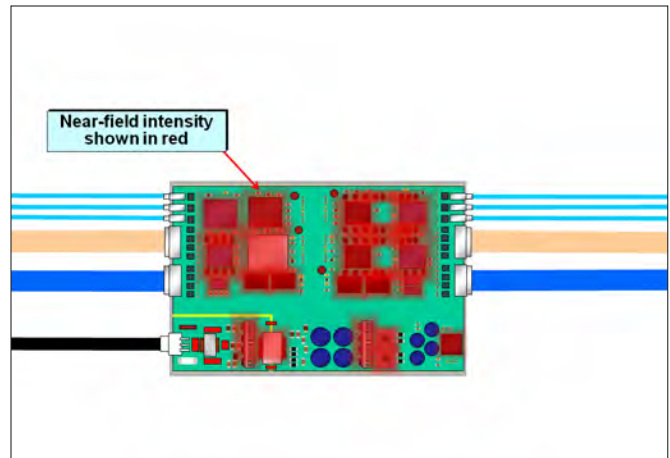

Figure 19. Near-field plot of the improved PCB assembly (simulated, or measured with near-field probes).

and EMI Simulation”, 23rd March 2011, Oxford, UK. www.ansys.com/staticassets/ANSYS%20UK/staticassets/Keith_Armstrong_Presentation_ANSYS_March_23%202011.pdf

- [2]. Armstrong, K. “EMC and Signal Integrity,” *Compliance Engineering*, March/April 1999.
- [3] “The Consumer Electronics Boom — How Semiconductor and Consumer Electronics Companies Can Improve Cost, Time-to-Market, and Product Quality,” KPMG LLP’s Information, Communication and Entertainment (ICE) Practice, 2008.
- [4] Armstrong, K. “BOM cost, and profitability,” *The EMC Journal*, May 2009, pp 32-34.
- [5] Armstrong, K. “Maxwell’s Equations, Quantum Electrodynamics, and good installation practices for SI, PI and EMC,” *The EMC Journal*, Issue 91, November 2010.
- [6] Armstrong, K. “The Physical Basis of EMC,” Armstrong/Nutwood UK, October 2010, ISBN: 978-0-9555118-3-7.
- [7] Armstrong, K. “EMC Design Techniques for Electronic Engineers,” Nutwood UK November 2010, ISBN: 978-0-9555118-4-4.
- [8] http://en.wikipedia.org/wiki/Vacuum_state
- [9] Feynman, R.P. “QED The Strange Theory of Light and Matter,” Penguin Books, 1990, ISBN: 0-14-012505-1.
- [10] Williams, T. “EMC for Product Designers, 4th Edition,” Elsevier 2007, ISBN-10: 0-750-68170-5, ISBN-13: 978-0-75-068170-4.
- [11] Klinger, M. “Modeling and Simulation of Powertrains for Electric and Hybrid Vehicles,” Workshop FR-AM-4-1, IEEE 2009 International Symposium on EMC, Austin, TX, Aug 17-21, 2009.
- [12] Armstrong, K. “EMC for Printed Circuit Boards – Basic and Advanced Design and Layout Techniques,” Nutwood UK December 2010, ISBN 978-0-9555118-5-1.
- [13] Archambeault, B. “The ‘Ground’ Myth”, 18 November 2008, <http://ewh.ieee.org/r6/phoenix/phoenixemc/PCB-Design.pdf>

KEITH ARMSTRONG graduated from Imperial College, London, in 1972 with an Honours degree in electrical engineering. He has been a member of the IEE since 1977, a UK Chartered Engineer since 1978, and a Group 1 European Engineer since 1988. He founded Cherry Clough Consultants in 1990. Keith can be reached at keith.armstrong@cherryclough.com.

CALENDAR

EVENTS

6th European Conference on Antennas and Propagation (EuCAP)

March 26-29, 2012, Prague, Czech Republic

EuCAP2012 provides an ideal and unique place in Europe for the exchange of scientific and technical information, at academic and industrial levels, on the latest results and developments in antenna theory and technology, in electromagnetic wave propagation on antenna measurement techniques.

INATRONICS 2012

March 28 - 31, Jakarta International Expo Center, Jakarta, Indonesia

The Indonesia's Only Electronics Industry Event in 2012, in which is designed to feature a full spectrum of products & services for electronic components, materials, assemblies and electronics production technology. The product spectrum is optimally geared to the market requirements.

www.inatronics-exhibition.net

2012 DoD E3 Program Review

April 2-6, Royal Plaza Hotel, Orlando, Fla.

The DoD E3 Program Review will provide an information exchange forum for DoD Components, the Federal Government, and Industry E3 and Spectrum professionals. The DoD E3 Program Review will feature unclassified presentations for General Session Forums conducted throughout the week and a ½ day Restricted Session Forum for "Distribution Controlled and Classified Presentations." This year will also include a full day Restricted Session Forum for the Navy Day.

ExpoElectronica

April 11-13, Crocus Expo, Moscow, Russia

The exhibition was launched in 1998 and in its 15 years of existence has rightly earned a reputation not just as an eagerly anticipated event and key place for demonstrating the latest developments and achievements in the electronics industry, but also as the main platform for leading industry professionals to meet and sign mutually beneficial, long-term contracts.

WAMICON 2012

April 16-17, Cocoa Beach, Fla.

IEEE Wireless and Microwave Technology (WAMI) Conference 2012 conference will address up-to-date multidisciplinary research needs and interdisciplinary aspects of wireless and RF technology.

ESTECH 2012

April 30- May 3, Doubletree by Hilton at the Entrance to Universal Orlando, Orlando, Fla.

ESTECH offers attendees a valuable educational experience with conference sessions and continuing education courses in the fields of design, test, and evaluation/product reliability; contamination control; aerospace; and nanotechnology.

www.iest.org/Meetings/ESTECH

IEEE International Magnetics Conference

May 7-11, Vancouver Convention Center, Vancouver, Canada

INTERMAG is the premier conference on all aspects of applied magnetism. The conference will provide a range of oral and poster presentations, invited talks and symposia, a tutorial session, and exhibits reviewing the latest developments in magnetism. Selected papers from the conference will be published in the IEEE Transactions on Magnetics.

<http://intermagconference.com/2012/>

The Fifteenth Meeting of the Symposium on Polymers for Microelectronics

May 8-10, Winterthur, Wilmington, Del.

The charter for the Symposium on Polymers for Microelectronics is to promote the study of the integration of polyimides and other advanced polymeric materials into semiconductor, thin film packaging, MEMS and optical application areas.

www.symposiumonpolymers.com/

SVIAZ-EXPOCOMM 2012

May 14-17, Expocentre Fairgrounds, Moscow, Russia

Every year it serves as the most excellent place for industry professionals to network, to promote technology and exchange information. Sviaz-Expocomm enjoys a high international standing and is one of the major events used by overseas IT manufacturers to promote their products and develop their business in Russia.

Electric Power 2012

May 15-17, Baltimore Convention Center, Baltimore, Md.

ELECTRIC POWER is the largest coal power conference in the U.S., offering more sessions and speakers and attracting more coal power producers than any other event. In addition, the leading users' group for PRB Coal holds its primary meeting at ELECTRIC POWER each year.

www.electricpowerexpo.com/

emv



Internationale Fachmesse mit Workshops
für Elektromagnetische Verträglichkeit

International Exhibition with Workshops
on Electromagnetic Compatibility (EMC)



EMV is the international discussion platform and showcase of the EMC industry. EMV 2013 takes place from 5 – 7 March 2013 in Stuttgart, Germany. The trade show and the workshops provide a comprehensive picture of the most recent EMC trends and highlights.

In times of ever more technical innovations, the challenges in the EMC field are steadily increasing. E-mobility and other new developments place high demands on EMC and safety. Ten times higher voltages and currents, increasing shielding requirements and new charging technologies for electric vehicles make discussions and the exchange of ideas and solutions important for the entire industry. The rapid development in the electronics industry is expected to continue. It is necessary to guarantee the reliable functioning of all the highly complex systems. EMV 2013 will provide the opportunity to gain hands-on experience in this area. In the previous years, a special action zone on e-mobility showcased electric cars and other exhibits.

EMV 2013 will provide the opportunity to gain hands-on experience in this area. In the previous years, a special action zone on e-mobility showcased electric cars and other exhibits. Impulse speeches informed many interested visitors about the newest development in this field. The organizer of EMV, Mesago Messe Frankfurt GmbH, is hoping to continue this successful cooperation with EMV Test NRW GmbH and its partners.

Another great opportunity to gather information is the exhibitor forum. Here, the exhibitors have the chance to present their company and their products.

EMV 2013 will offer numerous half-day workshops. Topics will range from EMC basics, to legal aspects or niche topics. For the participants these workshops provide the perfect opportunity to keep up with the current state of technology. The speakers have the chance to share their knowledge and experiences with their colleagues.

The proximity of workshops and exhibition creates unique synergies for all parties. EMV 2013 is the place where experts meet the experts.

Detailed information on EMV 2013 is available at www.e-emc.com. For questions and wishes please contact the EMV-Team directly at emv@mesago.com or +49 711 61496 63.

Exhibitor statements of EMV 2012:

"LCR has exhibited at many trade shows in the USA and China. We were impressed with the professional level of attendees which resulted in a higher quality of leads. We were also suitably impressed with the overall exhibition. We will definitely consider exhibiting at next years EMV show."

Nissen Isakov, President, LCR Electronics Inc.

"For us, the first time we were at the EMC, it was a successful show. We had a large number of interesting conversations and made many new business contacts."

Theo Hellmann, Magh und Boppert GmbH

"Small is beautiful! A must for all EMC professionals."

Mathias Kalmbach, WÜRTH ELEKTRONIK eiSos

2012 Asia-Pacific EMC Week

May 21-25, Singapore

The conference is aiming at providing a forum to continue and accelerate the momentum of researching in microwave technologies and related fields. The conference provides a unique opportunity for international scientists, engineers and scholars to share and exchange experiences.

www.apmc2012.com

2012 ESA Workshop on Aerospace EMC

May 21-23, Palazzo Cavalli Franchetti, Venice Italy

This workshop will establish a forum opportunity for EMC researchers and engineers involved in aerospace and give a wide picture of the present state of EMC technology and trends. It will also encourage awareness of, and foster discussion in future developments which will allow the EMC community to keep the pace of spacecraft and aircraft design advances and challenges.

www.congrex.nl/12A05/

IEEE EMC Society Chapter Meeting

May 28, Rhein Tech Laboratories, Washington/NOVA

Short pulses are inherently ultra-wideband (UWB) and have been the subject of interest for various applications such as wireless communications, high speed data transfer, fast switches, high speed interconnects, and medical sciences. Understanding the characteristics of UWB signals is best suited in time domain. Therefore, the beauty of time domain technique for example, finite-difference time-domain (FDTD) method for simulating various EM problems will be discussed. FDTD method provides wealth of information about the simulated device – applications towards the extraction will be demonstrated.

www.wll.com/academy.html

The 7th Annual European Spectrum Management Conference

June 19-20, The Management Centre Europe, Brussels

Now in its 7th year, the European Spectrum Management Conference has an established reputation as the major European meeting point of the year for stakeholders in the field of spectrum management, bringing together more than 280 participants on an annual basis.

http://eu-ems.com/summary.asp?event_id=112&page_id=848

Intersolar Europe

June 11-15, New Munich Trade Fair Centre, Munich, Germany

www.intersolar.de/

The 7th Annual European Spectrum Management Conference

June 19-20, The Management Centre Europe, Brussels

Now in its 7th year, the European Spectrum Management Conference has an established reputation as the major European meeting point of the year for stakeholders in the field of spectrum management, bringing together more than 280 participants on an annual basis.

http://eu-ems.com/summary.asp?event_id=112&page_id=848

Techno-Frontier 2012

July 11-13, Tokyo Big Sight, Tokyo, Japan

Visitors know that the latest technologies & products in Electronics and Mechatronics gather here. Each clearly-focused exhibition enables the professionals to locate what they need, and the wide range of the products sparks ideas on possibilities of technical coordination.

www.jma.or.jp/tf/en11/index.html

2012 IEEE EMC Society

Aug. 5-10, David L. Lawrence Convention Center, Pittsburgh, Pa.

This symposium is sponsored by the IEEE EMC Society will feature several concurrent technical sessions. You'll find an Exhibit hall with hundreds of booths filled with latest products, equipment and services. Later in the event we'll feature concurrent workshops / tutorials. In addition there are many collateral industry and profession meetings planned throughout the week. Finally, there are numerous formal and informal opportunities to network with old friends, meet new friends, experts, professionals and industry representatives.

<http://2012emc.org/>

MSPO 2012 - 20th International Defence Industry Exhibition

Sept. 3-6, Kielce, Poland

The 19th edition MSPO – facts and figures – 13,000 trade fair attendants, 25,000 square metres of the exhibition space, 400 exhibitors, international concerns, official delegations from 30 countries and the presence of the European Defence Agency.

34th Annual EOS/ESD Symposium & Exhibits

Sept. 9-14, Tucson, Ariz.

www.esda.org/symposia.html

electronica India 2012 & productronica India 2012

Sept. 11-13, Bangalore, BIEC

electronica India and productronica India clearly demonstrate their close links to the world's leading trade fairs electronica and productronica in Munich.

EMC EUROPE 2012 ROME

Sept. 17-21, Faculty of Engineering of "Sapienza" University of Rome, Rome, Italy

The Symposium will consist of 5-day oral and poster presentations, workshops, tutorials, special sessions, short-courses, industrial forum, and exhibits. The Preliminary Program, registration form, information on accommodation and social activities will be available in the web pages of the Symposium. The advanced registration fee will include the attendance to all technical sessions, social events, the electronic version of the Symposium Proceedings and Workshop Notes.

www.emceurope2012.it

2012 IEEE

International Symposium on Electromagnetic Compatibility

August 5 – 10, 2012

Pittsburgh, Pennsylvania



Learn the Leading Edge Info on:

- EM Interference and Environments
- Shielding, Grounding, Bonding
- EMP, Lightning, ESD
- Transient Suppression
- EMC Measurement
- Signal Integrity
- EMC Management
- Nanotechnology
- Spectrum Management
- EM Product Safety



PITTSBURGH, PA

BRIDGE TO EMC

Cross over with us to the city of bridges. This event will have something for everyone — from the novice EMC engineer to the advanced practitioner. This is an opportunity to advance your knowledge, build new relationships, and reconnect with industry friends from around the world.

EMC
SOCIETY®



For Complete Event Details Visit:
www.emc2012.isemc.org

STANDARDS

Compliance with standards makes or breaks the marketing of any new product. This section recaps new and revised national and international EMC standards. The information below has been featured in our weekly *Interference Technology eNews*. Just go to InterferenceTechnology.com, subscribe to the *eNews*, and you'll be updated on important changes in EMC standards weekly.

International Electrotechnical Commission (IEC)

EMC AND HEARING AIDS STANDARD

IEC 60118-13:2011 in principle covers all relevant EMC phenomena for hearing aids. Hearing aid immunity to high frequency electromagnetic fields originating from digital wireless devices operating in the frequency ranges 0.8 GHz to 0.96 GHz and 1.4 GHz to 2.48 GHz is currently identified as the only relevant EMC phenomenon regarding hearing aids. Future editions of this part of IEC 60118 may add tests for other frequency bands, as they come into more common use. IEC 61000-4-3 is the basis for relevant EMC tests to be conducted on hearing aids. Measurement methods and acceptance levels are described in this part of IEC 60118. This third edition cancels and replaces the second edition published in 2004 and constitutes a technical revision. It introduces a new set of requirements for use of hearing aids with mobile phones.

HIGH-VOLTAGE SWITCHGEAR AND CONTROLGEAR

Project IEC 62271-204 ed1.0, High-voltage switchgear and controlgear – Part 204: Rigid gas-insulated transmission lines for rated voltage above 52 kV, is an up to 3 months pre-release of the official publication.

This part of IEC 62271 applies to rigid HV gas-insulated transmission lines (GIL) in which the insulation is obtained, at least partly, by a non-corrosive insulating gas, other than air at atmospheric pressure, for alternating current of rated voltages above 52 kV, and for service frequencies up to and including 60 Hz.

It is intended that this international standard be used where the provisions of IEC 62271-

203 do not cover the application of GIL (see NOTE 3).

At each end of the HV gas-insulated transmission line, a specific element may be used for the connection between the HV gas-insulated transmission line and other equipment like bushings, power transformers or reactors, cable boxes, metal-enclosed surge arresters, voltage transformers or GIS, covered by their own specification.

ELECTRICAL INSULATING MATERIALS AND SYSTEMS

IEC/TS 61934 ed2.0, Electrical insulating materials and systems - Electrical measurement of partial discharges (PD) under short rise time and repetitive voltage

impulses, is applicable to the off-line electrical measurement of partial discharges (PD) that occur in electrical insulation systems (EIS) when stressed by repetitive voltage impulses generated from electronic power devices. Typical applications are EIS belonging to apparatus driven by power electronics, such as motors, inductive reactors and windmill generators. Excluded from the scope of this technical specification are:

- methods based on optical or ultrasonic PD detection,
- fields of application for PD measurements when stressed by non-repetitive impulse voltages such as lightning impulse or switching impulses from switchgear.

The principal changes with regard to the previous edition concern the addition of:

- an Introduction that provides some background information on the progress being made in the field of power electronics;
- impulse generators;
- PD detection methods;
- a new informative Annex C covering practical experience obtained from round-robin testing (RRT);
- example of noise levels, as shown in new informative Annex D.

IEC 61000-4-16 ED1.2 CONSOL. WITH AM1&2

Electromagnetic compatibility (EMC) - Part 4-16: Testing and measurement techniques - Test for immunity to conducted, common mode disturbances in the frequency range 0 Hz to 150 kHz IEC 61000-4-16:1998+A1:2001+A2:2009, establishes a common and reproducible basis for testing electrical and electronic equipment with the application of common mode disturbances to power supply, control, signal and communication ports. This standard defines test voltage and current waveform, range of test levels, test equipment, test set-up and test procedures. The test is intended to demonstrate the immunity of electrical and electronic equipment when subjected to conducted, common mode disturbances such as those originating from power line currents and return leakage currents in the earthing/grounding system.

ELECTROMAGNETIC ENVIRONMENTS

IEC/TR 61000-2-5:2011 is a Technical Report intended for guidance for those who are in charge of considering and developing immunity requirements. It also gives basic guidance for the selection of immunity levels. The data are applicable to any item of electrical or electronic equipment, sub-system or system that operates in one of the locations as considered in this Technical Report. It

has the status of a basic EMC publication in accordance with IEC Guide 107. Knowledge of the electromagnetic environment that exists at locations where electrical and electronic equipment and systems are intended to be operated is an essential precondition in the process of achieving electromagnetic compatibility. This knowledge can be obtained by various approaches, including a site survey of an intended location, the technical assessment of the equipment and system as well as the general literature.

SEMICONDUCTOR DEVICE STANDARD

Mechanical standardization of semiconductor devices - Part 6-12: General rules for the preparation of outline drawings of surface mounted semiconductor device packages - Design guidelines for fine-pitch land grid array (FLGA), IEC 60191-6-12:2011, provides standard outline drawings, dimensions, and recommended variations for all fine-pitch land grid array packages (FLGA) with terminal pitch of 0,8 mm or less. This edition includes the following significant changes with respect to the previous edition:

- scope is expanded so that this standard include the square type FLGA. The title of this standard has been changed accordingly: "Rectangular type" has been deleted from the title;
- ball pitch of 0,3 mm has been added;
- datum is changed from the body datum to the ball datum;
- combination lists of D, E, MD, and ME have been revised.

NEW CONNECTORS STANDARD

IEC 61076-2-106:2011 describes circular connectors with IP40 or IP65/67 protection degree, typically used for industrial process measurement and control. These connectors consist of fixed and free connectors, either rewirable or non-rewirable, with M16 x 0,75 screw-locking. Male connectors have round contacts \varnothing 1,5 mm or \varnothing 1,0 mm.

MICROPROCESSOR SYSTEM STANDARD

ISO/IEC/IEEE 60559:2011(E) specifies formats and methods for floating-point arithmetic in computer systems - standard and extended functions with single, double, extended, and extendable precision - and recommends formats for data interchange. Exception conditions are defined and standard handling of these conditions is specified. It provides a method for computation with floating-point numbers that will yield the same result whether the processing is done in hardware, software, or a combination of the two. The results of the computation will be identical, independent of implementation, given the same input data. Errors, and error conditions, in the mathematical processing will be reported in a consistent manner regardless of implementation. This first edition, published as ISO/IEC/IEEE 60559,

replaces the second edition of IEC 60559.

CONNECTORS STANDARD

IEC 60512-9-3:2011 defines a standard test method to assess the mechanical and electrical operational endurance, i.e. engaging and separating cycles, of a connector in an operating mode which includes a specified electrical load. This second edition cancels and replaces Test 9c of IEC 60512-5, issued in 1992, and constitutes a technical revision. The main technical changes with regard to the previous edition are as follows:

- An additional requirement to 4.1 stating that if more than one electrical circuit is wired for testing, the wiring shall be carried out in a parallel electrical circuit.
- Subclauses 4.3 through 4.7 were removed and replaced by 4.2 through 4.4.

SEMICONDUCTOR STANDARD

IEC 60749-40:2011 is intended to evaluate and compare drop performance of a surface mount semiconductor device for handheld electronic product applications in an accelerated test environment, where excessive flexure of a circuit board causes product failure. The purpose is to standardize test methodology to provide a reproducible assessment of the drop test performance of a surface mounted semiconductor devices while duplicating the failure modes normally observed during product level test. This international standard uses a strain gauge to measure the strain and strain rate of a board in the vicinity of a component.

RF CONNECTORS STANDARD

IEC 61169-35:2011(E) provides information and rules for preparation of detail specification of 2,92 series RF coaxial connectors together with the pro-forma blank detail specification. It also prescribes mating face dimensions for high performance connectors - grade 1, dimensional detail of standard test connectors - Grade 0, gauging information and tests selected from IEC 61169-1 applicable to all detail specifications relating to 2,92 series RF coaxial connectors. It cancels and replaces IEC/PAS 61169-35, published in 2009, of which it constitutes a minor revision. The only change is that the PAS has been changed into and International Standard.

SEMICONDUCTOR STANDARD

IEC 60749-30:2005+A1:2011 establishes a standard procedure for determining the preconditioning of non-hermetic surface mount devices (SMDs) prior to reliability testing. The test method defines the preconditioning flow for non-hermetic solid-state SMDs representative of a typical industry multiple solder reflow operation. These SMDs should be subjected to the appropriate preconditioning sequence described in this standard prior to being submitted to specific in-house reliability testing (qualification and/or reliability monitoring) in order to evaluate long term reliability (impacted by soldering

stress). This consolidated version consists of the first edition (2005) and its amendment 1 (2011). Therefore, no need to order amendment in addition to this publication.

EMC REQUIREMENTS FOR POWER SUPPLY UNITS

IEC 61204-3:2011 specifies electromagnetic compatibility (EMC) requirements for power supply units (PSUs) providing d.c. output(s) with or without auxiliary a.c. output(s), operating from a.c. or d.c. source voltages up to 600 V a.c. or 1 000 V d.c. The main changes with respect to the previous edition are listed below:

- Update of the scope to align with IEC 61204-7.
- Update of the normative references to the latest editions.
- Change of the definitions of environments to align with the latest editions of the applicable normative references.
- Revision of the applicability of tests to different power supply technologies.
- Revision of the emission limits and requirements to align with the latest editions of the applicable normative references.
- Revision of the immunity limits and requirements to align with the latest editions of the applicable normative references.
- Clarification of the different classes of PSU.

INTEGRATED CIRCUITS STANDARD

IEC 61967-8:2011 defines a method for measuring the electromagnetic radiated emission from an integrated circuit (IC) using an IC stripline in the frequency range of 150 kHz up to 3 GHz. The IC being evaluated is mounted on an EMC test board (PCB) between the active conductor and the ground plane of the IC stripline arrangement.

This publication is to be read in conjunction with IEC 61967-1:2002.

ELECTROMAGNETIC COMPATIBILITY STANDARD

IEC/TR 61000-3-15:2011(E) is concerned with the critical assessment of existing and emerging national and international standards for single and multi-phase dispersed generation systems up to 75 A per phase, particularly converters connected to the public supply low voltage network. This Technical Report intends to serve as a starting point and to ultimately pave the way for the definition of appropriate EMC requirements and test conditions. This Technical Report is limited to EMC issues (immunity and emission) up to 9 kHz and does not include other aspects of connection of generators to the grid. This Technical Report focuses on emission caused by distributed generation (mainly harmonics and inter-harmonics, DC emissions flicker, rapid voltage changes and fluctuations), as well as immunity aspects to normally occurring events in the public supply network

(voltage dips and short interruptions, frequency variations, harmonics and interharmonics). Every effort has been made to utilize already existing emission and immunity standards, including the test set-up and existing test equipment in use.

SEMICONDUCTOR AND MICRO-ELECTROMECHANICAL DEVICES STANDARD

IEC 62047-12:2011 specifies a method for bending fatigue testing using resonant vibration of microscale mechanical structures of MEMS (micro-electromechanical systems) and micromachines. This standard applies to vibrating structures ranging in size from 10 μm to 1 000 μm in the plane direction and from 1 μm to 100 μm in thickness, and test materials measuring under 1 mm in length, under 1 mm in width, and between 0,1 μm and 10 μm in thickness. The main structural materials for MEMS, micromachine, etc. have special features, such as typical dimensions of a few microns, material fabrication by deposition, and test piece fabrication by means of non-mechanical machining, including photolithography. The MEMS structures often have higher fundamental resonant frequency and higher strength than macro structures. To evaluate and assure the lifetime of MEMS structures, a fatigue testing method with ultra high cycles (up to 10¹²) loadings needs to be established. The object of the test method is to evaluate the mechanical fatigue properties of microscale materials in a short time by applying high load and high cyclic frequency bending stress using resonant vibration.

EMC EMISSION ASSESSMENT STANDARD

IEC/TR 61000-3-14:2011(E) is a Technical Report which provides guidance on principles that can be used as the basis for determining the requirements for the connection of disturbing installations to low voltage (LV) public power systems. For the purposes of this part of IEC 61000, a disturbing installation means an installation (which may be a load or a generator) that produces disturbances: harmonics and/or interharmonics, voltage flicker and/or rapid voltage changes, and/or voltage unbalance. The primary objective is to provide guidance to system operators or owners for engineering practices, which will facilitate the provision of adequate service quality for all connected customer installations. In addressing installations, this report is not intended to replace equipment standards for emission limits. This report addresses the allocation of the capacity of the system to absorb disturbances. It does not address how to mitigate disturbances, nor does it address how the capacity of the system can be increased.

SEMICONDUCTOR MAGNETIC AND CAPACITIVE COUPLER STANDARD

IEC/PAS 60747-17:2011(E) gives the terminology, essential ratings, characteristics, safety test and the measuring methods of magnetic and capacitive couplers.

It specifies the principles of magnetic and capacitive coupling across an isolation barrier and the related requirements for basic isolation and reinforced insulation.

RADIATION PROTECTION INSTRUMENTATION

IEC 61577-3:2011 describes the specific requirements for instruments measuring the volumetric activity of airborne short-lived radon decay products and/or their ambient potential alpha-energy concentration outdoors, in dwellings, and in workplaces including underground mines. This standard applies practically to all types of electronic instruments that are based on grab sampling, continuous sampling technique and electronic integrating measurement methods. This new edition includes the following significant technical changes with respect to the previous edition:

- implementation of new requirements and tests concerning radiation detection performance;
- implementation of new requirements and tests concerning environmental performance;
- harmonization of the requirements and tests concerning electrical and mechanical performance with other standards in the area of radiation protection instrumentation.

FIXED CAPACITORS STANDARD FOR USE IN ELECTRONIC EQUIPMENT

IEC 60384-2:2011 applies to fixed capacitors for direct current, with metallized electrodes and polyethylene-terephthalate dielectric for use in electronic equipment. These capacitors may have "self-healing properties" depending on conditions of use. They are primarily intended for applications where the a.c. component is small with respect to the rated voltage. Two performance grades of capacitors are covered, Grade 1 for long-life application and Grade 2 for general application. Capacitors for electromagnetic interference suppression and surface mount fixed metallized polyethylene-terephthalate film dielectric d.c. capacitors are not included, but are covered by IEC 60384-14 and IEC 60384-19 respectively. This fourth edition cancels and replaces the third edition published in 2005 and contains the following significant technical changes with respect to the previous edition.

- Table 1, Sampling plan together with numbers of permissible non-conformance for qualification approval test, has been adjusted.
- Table 3, Lot-by-lot inspection, has been changed, highlighting assessment level EZ only.
- Table 4, Periodic inspection, has been changed, highlighting assessment level EZ only.
- The preferred values of rated voltages have been updated in conformance with the basic series of preferred values R5 and R10 given in ISO 3.

CONNECTORS FOR ELECTRONIC EQUIPMENT

IEC 60603-7:2008+A1:2011 covers 8-way unshielded free and fixed connectors and is intended to specify the

common dimensions, mechanical, electrical and environmental characteristics and tests for the family of IEC 60603-7-x connectors. These connectors are interchangeable and interoperable with other IEC 60603-7 series connectors. This new edition includes the following significant technical changes with respect to the previous edition:

- updated drawings and test schedules on the basis of IEC 60603-7-4;
- corrected figure illustrating a connector de-rating curve.

This consolidated version consists of the third edition (2008) and its amendment 1 (2011). Therefore, no need to order amendment in addition to this publication.

COAXIAL COMMUNICATION CABLES

IEC 61196-8-1:2012 is part of the IEC 61196 series and applies to coaxial communications cables described in IEC 61196-8. It specifies the requirements for semi-flexible radio frequency and coaxial cables with polytetrafluoroethylene (PTFE) dielectric. These cables are for use in microwave and wireless equipment or other signal transmission equipment or units at frequencies from 500 MHz up to 18 GHz. This blank detail specification is to be read in conjunction with IEC 61196-1 and IEC 61196-8. The blank detail specification determines the layout and style for detail. Detail specifications, based on the blank detail specification, may be prepared by a national organization, a manufacturer or a user.

EMC METALLIC COMMUNICATION CABLE TEST METHODS

Project IEC 62153-4-14 ed1.0 Final Draft International Standard is an up to 3 months' pre-release of the official publication. It is available for sale during its voting period: 2012-02-17 to 2012-04-20. By purchasing this FDIS now, you will automatically receive, in addition, the final publication.

International Organization for Standardization (ISO) / IEC

INFORMATION TECHNOLOGY SOFTWARE MEASUREMENT STANDARD

ISO/IEC 14143-2:2011, functional size measurement -- Part 2: conformity evaluation of software size measurement methods to ISO/IEC 14143-1:

- establishes a framework for the conformity evaluation of a Candidate FSM Method against the provisions of ISO/IEC 14143-1;
- describes a process for conformity evaluation of whether a Candidate FSM Method meets the (type) requirements of ISO/IEC 14143-1 such that it is an actual FSM method, i.e. they are of the same type;
- describes the requirements for performing a

conformity evaluation in order to ensure repeatability of the conformity evaluation process, as well as consistency of decisions on conformity and the final result;

- aims to ensure that the output from the conformity evaluation process is objective, impartial, consistent, repeatable, complete and auditable;
- provides informative guidelines for determining the competence of the conformity evaluation teams;
- provides an example checklist to assist in the conformity evaluation of a Candidate FSM Method; and
- provides an example template for the conformity evaluation report.

RFID CONFORMANCE TEST METHODS

ISO/IEC 18047-2:2012 defines test methods for determining the conformance of radio frequency identification (RFID) devices (tags and interrogators) for item management with the specifications given in ISO/IEC 18000-2, but does not apply to the testing of conformity with regulatory or similar requirements.

The test methods require only that the mandatory functions, and any optional functions which are implemented, be verified. This may, in appropriate circumstances, be supplemented by further, application-specific functionality criteria that are not available in the general case.

The interrogator and tag conformance parameters in ISO/IEC 18047-2:2012 are the following:

- mode-specific conformance parameters including nominal values and tolerances;
- parameters that apply directly affecting system functionality and inter-operability.

The following are not included in ISO/IEC 18047-2:2012:

- parameters that are already included in regulatory test requirements;
- high-level data encoding conformance test parameters (these are specified in ISO/IEC 15962).

Unless otherwise specified, the tests in ISO/IEC 18047-2:2012 are to be applied exclusively to RFID tags and interrogators defined in ISO/IEC 18000-2.

International Special Committee on Radio Interference (CISPR)

PRE-RELEASE ON ELECTROMAGNETIC COMPATIBILITY OF MULTIMEDIA EQUIPMENT

This International Standard applies to multimedia equipment (MME) as defined in 3.1.23 and having a rated r.m.s. AC or DC supply voltage not exceeding 600 V. Equipment within the scope of CISPR 13 or CISPR 22 is within the scope of this publication. MME intended primarily for professional use is within the scope of this publication. The radiated emission requirements in this standard are not intended to be applicable to the inten-

tional transmissions from a radio transmitter as defined by the ITU, nor to any spurious emissions related to these intentional transmissions. Equipment, for which emission requirements in the frequency range covered by this publication are explicitly formulated in other CISPR publications (except CISPR 13 and CISPR 22), are excluded from the scope of this publication.

FCC ACCEPTANCE OF CISPR 22 DATA

The FCC accepts measurement data for unintentional unlicensed Part 15 devices using CISPR 22 1997 standard. However, most manufacturers and some test laboratories believe that the FCC accepts measurement data based on any CISPR 22 standard, regardless of the year. In fact, 47CFR 15.38(a) lists only the third edition of the International Special Committee on Radio Interference (CISPR), Pub. 22, "Information Technology Equipment—Radio Disturbance Characteristics—Limits and Methods of Measurement," 1997, IBR approved for §15.109. The FCC accepts data based only on this CISPR edition. For any other edition or year to be acceptable, it would have to be included in the list in 47CFR 15.38(a), or included in a policy from the FCC, as described here in FCC 47CFR 15.38(a) "Incorporation by reference" rule: "The materials listed in this section are incorporated by reference in this part. These incorporations by reference were approved by the Director of the Federal Register in accordance with 5 U.S.C. 552(a) and 1 CFR part 51. These materials are incorporated as they exist on the date of the approval, and notice of any change in these materials will be published in the Federal Register."

We have no knowledge of FCC dismissals as a result of using other CISPR 22 standard versions and dates; nonetheless, FCC 47CFR15.38(a) lists CISPR 22 1997 standard as the only alternative standard for Part 15 device measurement data.

EMC REQUIREMENTS FOR HOUSEHOLD APPLIANCES

CISPR 14-1:2005+A1:2008+A2:2011 applies to the conduction and the radiation of radio-frequency disturbances from appliances whose main functions are performed by motors and switching or regulating devices, unless the R.F. energy is intentionally generated or intended for illumination. It includes such equipment as:

- household electrical appliances,
- electric tools,
- regulating controls using semiconductor devices,
- motor-driven electro-medical apparatus,
- electric/electronic toys,
- automatic dispensing machines as well as cine or slide projectors.

Also included in the scope of this standard are separate parts of the above mentioned equipment such as motors, and switching devices relays (power or protective). However, no emission requirements apply unless formulated in this standard. The frequency range covered is 9 kHz to 400 GHz. Multi-

function equipment which is subjected simultaneously to different clauses of this standard and/or other standards shall meet the provisions of each clause/standard with the relevant functions in operation; details are given in 7.2.1. The limits in this standard have been determined on a probabilistic basis, to keep the suppression of disturbances economically feasible while still achieving an adequate radio protection. In exceptional cases radio frequency interference may occur, in spite of compliance with the limits. In such a case, additional provisions may be required. The effects of electromagnetic phenomena relating to the safety of apparatus are excluded from the scope of this standard. This consolidated version consists of the fifth edition (2005), its amendment 1 (2008) and its amendment 2 (2011). Therefore, no need to order amendments in addition to this publication.

ELECTROMAGNETIC COMPATIBILITY OF MULTIMEDIA EQUIPMENT STANDARD

CISPR 32:2012 International Standard applies to multimedia equipment (MME) having a rated r.m.s. AC or DC supply voltage not exceeding 600 V. Equipment within the scope of CISPR 13 or CISPR 22 is within the scope of this publication. MME intended primarily for professional use is within the scope of this publication. The radiated emission requirements in this standard are not intended to be applicable to the intentional transmissions from a radio transmitter as defined by the ITU, nor to any spurious emissions related to these intentional transmissions. Equipment, for which emission requirements in the frequency range covered by this publication are explicitly formulated in other CISPR publications (except CISPR 13 and CISPR 22), are excluded from the scope of this publication. This document does not contain requirements for in-situ assessment. Such testing is outside the scope of this publication and may not be used to demonstrate compliance with it. This publication covers two classes of MME (Class A and Class B). The objectives of this publication are to establish requirements which provide an adequate level of protection of the radio spectrum, allowing radio services to operate as intended in the frequency range 9 kHz to 400 GHz and to specify procedures to ensure the reproducibility of measurement and the repeatability of results.

EMC FILTERING DEVICES STANDARD

CISPR 17:2011 specifies methods to measure the radio interference suppression characteristics of passive EMC filtering devices used in power and signal lines, and in other circuits. The defined methods may also be applied to combinations of over-voltage protection devices and EMC filtering devices. The measurement method covers the frequency range from 9 kHz to several GHz depending on the device and test circuit. The standard describes procedures for laboratory tests (type tests) as well as factory tests. The suppression characteristics of EMC filters and components used for the suppression of

EM disturbances, are a function of numerous variables such as impedance of the circuits to which they connect, operating voltage and current, and ambient temperature. This standard specifies uniform test methods that will enable comparison of filtering and suppression characteristics determined by test laboratories or specified by manufacturers. Measurement procedures are provided for unbiased and bias conditions.

European Telecommunications Standards Institute (ETSI)

HARMONIZED EUROPEAN STANDARD

ETSI EN 302 729-2 V1.1.2 specifies the requirements for Level Probing Radar (LPR) applications based on pulse RF, FMCW or similar wideband techniques.

LPRs are used in many industries concerned with process control to measure the amount of various substances (mostly liquids or granulates). LPRs are used for a wide range of applications such as process control, custody transfer measurement (government legal measurements), water and other liquid monitoring, spilling prevention and other industrial applications. The main purposes of using LPRs are:

- to increase reliability by preventing accidents;
- to increase industrial efficiency, quality and process control;
- to improve environmental conditions in production processes.

LPR always consist of a combined transmitter and receiver and are used with an integral or dedicated antenna. The LPR equipment is for professional applications to which installation and maintenance are performed by professionally trained individuals only.

EMC AND RADIO SPECTRUM MATTERS

ETSI EN 305 550-2 V1.1.1 is a new standard that takes advantage of technical developments within the SRD industry. In particular this includes the development in technologies which makes applications in the higher frequency range possible. This standard is part 2 of a multi-part deliverable covering Electromagnetic compatibility and Radio spectrum Matters (ERM); Short Range Devices (SRD); Radio equipment to be used in the 40 GHz to 246 GHz frequency range.

RADIO EQUIPMENT AND SERVICES

ETSI EN 301 489-1 V1.9.2 contains the common requirements for radio communications equipment and associated ancillary equipment, in respect of Electromagnetic Compatibility (EMC).

Product dependent arrangements necessary to perform the EMC tests on dedicated types of radio communications equipment, and the assessment of test results, are detailed in the appropriate product related parts of

EN 301 489 series [i.13].

The present document, together with the product related part, specifies the applicable EMC tests, the methods of measurement, the limits and the performance criteria for radio equipment and associated ancillary equipment. In case of differences (for instance concerning special conditions, definitions, abbreviations) between part 1 of EN 301 489 series [i.13] and the relevant product related part of EN 301 489 series [i.13], the product related part takes precedence.

Technical specifications related to the antenna port of radio equipment and radiated emissions from the enclosure port of radio equipment and combinations of radio and associated ancillary equipment are not included in the present document. Such technical specifications are normally found in the relevant product standards for the effective use of the radio spectrum.

The environment classification used in the present document refers to the environment classification used in:

- EN 61000-6-3 [i.4] and EN 61000-6-1 [i.5] for the residential, commercial and light industrial environment; or
- TR 101 651 [i.6] for the telecommunication centre environment; or
- ISO 7637-2 [8] for the vehicular environment.

The EMC requirements have been selected to ensure an adequate level of compatibility for apparatus intended to be used in the environments mentioned above. The levels, however, do not cover extreme cases which may occur in any location but with low probability of occurrence.

PORTABLE VERY HIGH FREQUENCY RADIOTELEPHONE EQUIPMENT STANDARD

This standard states the minimum technical characteristics and methods of measurement required for portable Very High Frequency (VHF) radiotelephones with integrated handheld class D DSC operating in certain frequency bands allocated to the maritime mobile service using either 25 kHz channels or 25 kHz and 12,5 kHz channels.

Institute of Electrical and Electronics Engineers (IEEE)

NEW COMMUNICATION STANDARDS FOR SMART GRID METERING DEVICES

Among the efficiencies promised by the smart grid is the use of metering devices that not only report usage to utilities but also inform users how to schedule consumption to lower-cost off-peak hours or even control that consumption automatically. Two new IEEE standards provide multisource “plug and play” environments for the millions of metering devices in the field now and in

the future. Both standards solve problems associated with single-source systems and with multisource systems based upon proprietary communications protocols.

IEEE 1702™, “IEEE Standard for Telephone Modem Communication Protocol to Complement the Utility Industry End Device Data Tables” is for devices using the ANSI C12.21 telephone modem communication interface. IEEE 1701™, “IEEE Standard for Optical Port Communication Protocol to Complement the Utility Industry End Device Data Tables,” (also known as MC1218 and ANSI C12.18) is for devices using the ANSI Type 2 optical port interface.

STANDARD LIMITING INSERTION OF HARMONICS INTO POWER GRID

The IEEE Standards Association (IEEE-SA) Standards Board approved two new projects to develop standards that will limit the injection of harmonic frequencies into the public electric transmission system. Harmonic pollution is a growing problem caused by the widespread use of power supplies and other non-linear loads. It can result in power loss and equipment damage and it may also be related to environmental safety issues. Both standards will address harmonic injection in 60Hz and 120V/240V systems such as those in use in the United States, Canada and other regions of the world. Both standards will also use the IEC SC77A and IEC 61000-3-12 standards as seed documents.

NEW WIRELESS NETWORK STANDARD FILLS IN THE WHITE SPACE

The wireless spectrum was carved up in the mid-20th century with protection of commercial radio and television signals as its primary concern. One example of this was the practice of leaving “white space” between broadcast channels to prevent interference by analog signals crowded too close together. Especially since the dawn of the digital age, technology has gotten better and better at reclaiming such underutilized slices of this spectrum, creating a wide array of new markets and applications that have opened up communication in revolutionary ways—without degrading performance by legacy spectrum users

A new standard, IEEE 1900.4a™-2011, defines additional components of the IEEE 1900.4™ system to enable mobile wireless access service in white space frequency bands without any limitation on used radio interface (physical and media access control layers, carrier frequency, etc.).

WIRELESS LAN MEDIUM ACCESS CONTROL AND PHYSICAL LAYER SPECIFICATIONS

This revision specifies technical corrections and clarifications to IEEE Std 802.11 for wireless local area networks (WLANs) as well as enhancements to the existing medium access control (MAC) and physical layer (PHY) functions. It also incorporates Amendments 1, 2, 3, 4, 5,

7, 8, 9, and 10.

Other News

FCC PROPOSES RULES CHANGES TO IMPROVE WIRELESS COVERAGE

The Federal Communications Commission adopted a Notice of Proposed Rulemaking (NPRM) to facilitate the development and deployment of well-designed signal boosters, which hold great potential to empower consumers in rural and underserved areas to improve their wireless coverage.

Coverage gaps exist within those service areas and continue to pose a problem for residents, particularly in rural areas. Signal boosters are part of the solution to addressing coverage gaps in rural areas. The regulatory framework for signal boosters proposed in this Notice of Proposed Rulemaking (NPRM) is one element in a set of initiatives designed to promote deployment of mobile voice and broadband services in the United States.

EMC AND ELECTRICAL PROTECTION

This technical report addresses electromagnetic compatibility and protection of telecommunications equipment that is typically used by telecommunications service providers. Topics covered included ESD, EMI (both emissions and susceptibility), Lightning, Power Induction (transient and steady state), Power Contact, Corrosion, and DC Power.

FCC FINALIZES RULES FOR BROADBAND FROM WALL SOCKETS

The Federal Communications Commission affirmed its rules for Broadband over Power Lines with minor modifications. The new rules provide a balance between providing for Access BPL technology that has potential applications for broadband and Smart Grid while protecting incumbent radio services against harmful interference. The rules have been modified "to increase the required notch filtering capability for systems operating below 30 MHz from 20 to 25 dB; establish a new alternative procedure for determining site-specific extrapolation factors...; and adopts a definition for the 'slant-range distance' used in the BPL measurement guidelines to further clarify its application."

BPL allows electrical utilities to deliver broadband service over medium voltage lines to homes and businesses through electrical wall sockets. It also allows them to monitor power usage in the form of Smart Grid applications.

STANDARD TOPICAL OUTLINES FOR QUALIFICATION OF NONDESTRUCTIVE TESTING PERSONNEL

Recommended Practice No. SNT-TC-1A: Personnel Qualification and Certification in Nondestructive Test-

ing (2011) provides guidelines for employers to establish in-house certification programs for the qualification and certification of nondestructive testing personnel. Since 1966, employers have used this industry-valued document as the general framework for their NDT certification programs. This revision provides updated training and certification requirements for Level I, II and III personnel. New content on:

- Guided Wave and Ground Penetrating Radar as Methods
 - Radiological Testing Method which includes: Radiographic Testing, Computed Radiography, Computed Tomography, and Digital Radiography.
 - Ultrasonics, Time of Flight Diffraction and Phased Array as Techniques
 - Additional Example Questions
- ANSI/ASNT CP-105: Training Outlines for Qualification of Nondestructive Personnel (2011) is included.

NEW LAW FOCUSES ON RARE METALS IN ELECTRONICS

A provision on "conflict minerals" that was slipped into a 2010 financial reform law, the Dodd-Frank Act, will help educate American consumers on what is in their smart phones, computers and other electronics and where U.S. electronics manufacturers are getting those rare metals. In the jungles and mountains of the Democratic Republic of the Congo, armed groups have been wreaking havoc and getting much of their funding from mining rare metals during the area's 13-year-long civil war.

STANDARD FOR EM EXAMINATION OF FERROMAGNETIC STEEL WIRE ROPE

ASTM E1571 - 11 outlines a procedure to standardize an instrument and to use the instrument to examine ferromagnetic wire rope products in which the magnetic flux and magnetic flux leakage methods are used. If properly applied, the magnetic flux method is capable of detecting the presence, location, and magnitude of metal loss from wear, broken wires, and corrosion, and the magnetic flux leakage method is capable of detecting the presence and location of flaws such as broken wires and corrosion pits.

The instrument's response to the rope's fabrication, installation, and in-service-induced flaws can be significantly different from the instrument's response to artificial flaws such as wire gaps or added wires. For this reason, it is preferable to detect and mark (using set-up standards that represent) real in-service-induced flaws whose characteristics will adversely affect the serviceability of the wire rope.

SOCIETIES

IEEE Electromagnetic Compatibility Society (S-27)

Headquarters:

IEEE Operations Center
445 Hoes Lane, P.O. Box 6804
Piscataway, NJ 08855-1331
Phone: (732) 981-0060
www.emcs.org

President: Ghery Pettit, ghery.pettit@intel.com

The Institute of Electrical & Electronics Engineers

(IEEE), the world's largest professional engineering society, is a global organization of individuals dedicated to improving the understanding of electrical and electronics engineering and its applications to the needs of society. The parent organization has over 360,000 members, approximately 70 percent of whom belong to technical groups such as the EMC Society.

Membership in the IEEE is on a qualified basis, with a basic annual fee of between \$140 and \$180 depending on the region of the world. The U.S. fee is \$183. The Institute offers major medical and life insurance at low group rates, and each member receives a copy of the monthly publication, *Spectrum*. Affiliate, associate, and student memberships are available for those who do not qualify for regular membership; and special arrangements are provided for those temporarily out of work. Members may join one or more of the 39 technical societies by paying the additional individual society fee(s). The EMC Society has an annual fee of \$30. Student memberships are \$15.

The EMC Society, which enjoys a membership of over 5000, functions through a Board of Directors elected by the Society membership. The Board includes 20 members-at-large who serve staggered 3-year terms. The Executive Board consists of the President, President-Elect, Immediate Past President, Secretary, Treasurer, and five Vice Presidents, who oversee the activities of standing and technical committees. The officers are elected by the Board of Directors. The annual IEEE International Symposium on Electromagnetic Compatibility is sponsored by the Board of Directors, which also coordinates activities of standing technical and ad hoc committees.

EMC Society publications include *Transactions on EMC*, a quarterly journal which features state-of-the-art papers on interference technology and EMC, and the *EMC Society Newsletter*, a quarterly newsletter of society activities, industry developments, practical papers, and notices of meetings, regulations, and new publications.

The EMC Society also has a group of distinguished lec-

turers who are available to present talks to IEEE and other organizations. The Society subsidizes the lecturers' expenses, and organizations are encouraged to contact the society for further details.

Chairmen of these committees welcome assistance and indications of interest in committee activities from the EMC Society membership. EMC Society activities are provided by 54 chapters with members in 61 countries worldwide.

A Committee Directory, listing officer, board, committee, and chapter contacts' names, addresses, and telephone numbers, is available on the IEEE EMC Society website at www.emcs.org.

The EMC Society is also active in technical conferences and symposia through its sponsorship of the annual International Electromagnetic Compatibility Symposium and participation in other worldwide symposia. Symposia and conferences are announced in the *EMC Society Newsletter*.

The IEEE Symposium on Electromagnetic Compatibility will be held in Long Beach, Calif. USA from August 14-19, 2011. Visit the Symposium website at www.emc2011.org.

The EMC Society has published a number of standards. For information on EMC Society and other IEEE standards, contact the IEEE Operations Center, 445 Hoes Lane, P.O. Box 6804, Piscataway, NJ 08855-1331; Phone: (732) 981-0060.

2012 Events

IEEE EMC Society Board of Directors Meetings

- March 16-18, 2012, Scottsdale, Arizona
- August 5 and 9, 2012, Pittsburgh, Pennsylvania
- November 16-18, 2012, Raleigh, North Carolina

IEEE EMC Chapter Colloquium and Exhibition "Table-Top Shows"

- March 5, Williamsburg, Virginia, Advances in Antenna Test and Measurement, Various speakers, with keynote address by Erik Vedeler, Head of Electromagnetics and Sensor Branch at NASA Langley Research Center
- March 27, Milwaukee, Wisconsin, Jeremy Campbell, PE, General Motors, Applied Technology Center, "Designing a Product to Meet Today's Emission and Immunity Requirements"
- April 11, Beaverton, Oregon, Elya Joffe, Lead author of the book "The Grounds for Grounding", will discuss grounding and other EMC-related topics
- May 8, Chicago, Illinois, Speakers and topics to be announced
- May 16, Detroit, Michigan, Todd Hubing of

- Clemson University on Automotive EMC Topics
October 11, Santa Clara, California, with speakers Doug Smith on ESD and Dr. Ege Engin of San Diego State University on Power Integrity

IEEE Product Safety Engineering Society

While product safety had been addressed in various committees over the years, there was never a professional society or symposium solely devoted to product safety engineering as a discipline until recently. The IEEE Product Safety Engineering Society (PSES) began operation on 1 January 2004.

The field of interest of the Society is the theory, design, development and implementation of product safety engineering for electronic and electro-mechanical equipment and devices. This includes the theoretical study and practical application of analysis techniques, testing methodologies, conformity assessments, and hazard evaluations.

The Society's mission is to strive for the advancement of the theory and practice of applied electrical and electronic engineering as applied to product safety and of the allied arts and sciences.

The Society provides a focus for cooperative activities, both internal and external to IEEE, including the promotion and coordination of product safety engineering activities among IEEE entities. In addition, the Society will provide a forum for product safety engineering professionals and design engineers to discuss and disseminate technical information, to enhance personal product safety engineering skills, and to provide product safety engineering outreach to engineers, students and others with an interest in the field. The Society is accepting members at any time during the calendar year, both full IEEE members and affiliate members. Membership is available at www.ieee.org/services/join/.

The IEEE Product Safety Engineering Society works closely with various IEEE Societies and Councils that also include product safety engineering as a technical specialty. Currently there are 14 chapters with more in the formation process.

Every year, the PSES hosts a Symposium on Product Compliance Engineering. The next conference will be in Portland, Oregon, USA on November 5-7, 2012. The Symposium will consist of Technical Sessions, Workshops, Tutorials and Demonstrations specifically targeted to the compliance engineering professional. Attendees will have the opportunity to discuss problems with vendors displaying the latest regulatory compliance products and services. For more information, visit <http://www.ieee-pses.org/symposium/>. Past papers from the Symposia are available in IEEE Xplore or on CD (for a fee).

In addition to hosting an annual conference, the PSES provides the opportunity for product safety engineers to publish technical papers in a newsletter. See <http://www.>

[ieeee-pses.org/newsletters.html](http://www.ieee-pses.org/newsletters.html). For further information and details on the Society, including becoming an author, please visit the website at www.ieee-pses.org.

dB Society

This unique, interesting, and exclusive fraternity of EMC engineers was founded in 1975 by 10 eminent EMC engineers. The purpose of the dB Society is to open doors within the EMC community. Its primary objectives are to greet and to welcome new engineers, suppliers, vendors, and manufacturers to the EMC community and to assist them in establishing contacts in the EMC field.

The following membership requirements are unique and rigidly enforced:

- Ten years of service to the EMC community,
- Five years of service to a recognized professional, EMC organization,
- Sponsorship by two Duo-Decade members,
- Favorable recommendations by three other recognized individuals in the EMC community, and
- Acceptance by the Admissions Board.

Business meetings and informal, relaxed get-togethers take place during major EMC functions. A formal evening social function is the highlight of each year and is usually conducted during the IEEE EMC Symposium. All meetings are for members only.

U.S. membership is limited to 100 EMC engineers. There are Society affiliates in the United Kingdom, India, and Israel. Qualified candidates are invited to write to:

The dB Society

22117 NE 10th Place
Sammamish, WA 98074
FAX: (425) 868-0547
E-mail: j.n.oneil@ieeee.org

ESD Association

Headquarters:

ESD Association
7900 Turin Road, Building 3
Rome, NY 13440-2069
phone: 315-339-6937
fax: 315-339-6793
email: info@esda.org
website: www.esda.org

Founded in 1982, the ESD Association is a professional voluntary association dedicated to advancing the theory and practice of electrostatic discharge (ESD) avoidance. From fewer than 100 members, the Association has grown to more than 2,000 members throughout the world. From an initial emphasis on the effects of ESD on electronic components, the Association has broadened its horizons to include areas such as textiles, plastics, web pro-

cessing, cleanrooms, and graphic arts. To meet the needs of a continually changing environment, the Association is chartered to expand ESD awareness through standards development, educational programs, local chapters, publications, tutorials, certification, and symposia.

ELECTROSTATIC DISCHARGE (ESD) TECHNOLOGY ROADMAP

In the late 1970s, electrostatic discharge, or ESD, became a problem in the electronics industry. Low-level ESD events from people were causing device failures and yield losses. As the industry learned about this phenomenon, both device design improvements and process changes were made to make the devices more robust and processes more capable of handling these devices. With devices becoming more sensitive through the year 2010, it is imperative that companies begin to determine the ESD capabilities of their handling processes. The ESD Technology Roadmap can be downloaded at: www.esda.org

ANSI/ESD S20.20 CONTROL PROGRAM STANDARD AND CERTIFICATION

A primary direction for the association is the continued implementation of a facility certification program in conjunction with ISO registrars. With the association's ESD control program standard, ANSI/ESD S20.20: Protection of Electrical and Electronic Parts, Assemblies and Equipment (Excluding Electrically Initiated Explosive Devices), the Association offers a means of independently assessing a company's ESD control program and of issuing a formal ANSI/ESD S20.20 certification.

The ANSI/ESD S20.20 standard covers the requirements necessary to design, establish, implement, and maintain an ESD control program to protect electrical or electronic parts, assemblies and equipment susceptible to ESD damage from Human Body Model (HBM) discharges greater than or equal to 100 volts. Developed in response to the Military Standardization Reform Act, ANSI/ESD S20.20 has been formally adopted for use by the U.S. Department of Defense.

Although ESD programs have been part of some ISO 9000 audits in the past, the assessment frequently has been cursory and actual judgment of the program has been left to the individual auditor. ANSI/ESD S20.20 provides a formal, consistent process standard that can be audited. It provides a single, auditable ESD standard for OEM's, suppliers, and contractors. To date, there are approximately 132 facilities in 13 countries that have become ANSI/ESD S20.20 certified.

Accredited registrars conduct the actual assessments of the companies. The association has developed a training program for the registrars and supervises registrar witness audits. This independent assessment of a company's ESD control program could be performed as part of the company's ISO 9000 surveillance audit or as a separate audit. Currently, there are 161 trained auditors in 13 countries who have been certified to conduct ANSI/ESD S20.20 audits.

In addition, the ESD Association offers an ESD program

documentation review service. For a fee of \$1,500 (US), members of the ESD Association's Facility Certification committee will review your ESD program documentation and will compare it to the requirements listed in ANSI/ESD S20.20-2007. Facilities that choose to become certified will use the ANSI/ESD S20.20-2007 standard as the basis for their certification. A report will be provided that describes the areas that need to be improved for documentation to be compliant with ANSI/ESD S20.20-2007. This service should be considered a MUST for any company that is preparing for facility certification based on ANSI/ESD S20.20-2007.

SYMPOSIA, TUTORIALS, AND PUBLICATIONS

As part of its commitment to education and technology, the association holds the annual EOS/ESD Symposium, which places major emphasis on providing the knowledge and tools needed to meet the challenges of ESD. Scheduled for September 9-14, 2012, at the Westin Tucson, La Poloma, Arizona, USA, the annual Symposium attracts attendees and contributors from around the world. Technical sessions, workshops, authors' corners, seminars, tutorials, and technical exhibits provide a myriad of opportunities for attendees to expand their knowledge of ESD.

In addition to tutorials and seminars, the association offers a number of publications and reference materials for sale. These range from proceedings of past EOS/ESD Symposia to textbooks written by experts in the field of ESD.

TechAmerica

Electromagnetic Compatibility Committee (G-46) Headquarters

TechAmerica
1401 Wilson Blvd., Suite 1100
Arlington, VA 22209
Phone: (703) 284-5344
www.geia.org

TechAmerica is the association that was created by the merger of AeA and ITAA. Earlier in 2008, ITAA and GEIA merged. The result of these mergers is an organization that is the leading voice for the U.S. technology industry, which is the driving force behind productivity growth and jobs creation in the United States. TechAmerica is the technology industry's only grassroots-to-global advocacy network. With nearly 1200 member companies, 20 regional councils and offices in Beijing and Brussels, the association represents the full spectrum of the technology industry.

TechAmerica is the technology industry's only grassroots-to-global advocacy network. The organization has expanded initiatives in areas such as: information Assurance / Information Security, Identity Management, Cloud Computing, Global Sourcing / Globalization, Intelligence agencies, Department of Defense & NASA, and State & Lo-

cal programs and public policy advocacy.

TechAmerica provides programs for business development, networking and market intelligence in the Federal arena, dealing with government entities such as Department of Defense, Homeland Security, Federal Communications Commission, Federal Trade Commission, Congress, as well as with state and local governments.

TechAmerica has a team of public policy professionals at state, federal and international levels, that allow the organization to successfully influence legislative and regulatory issues that affect member companies.

In addition, TechAmerica offers an active standards development program to provide industry with proven solutions to business process challenges. The program is nationally and internationally recognized for its leadership and expertise in the development of standards. Configuration Management, Systems Engineering, Systems Safety, Earned Value Management, Logistics, Reliability and Electromagnetic Compatibility (EMC) area where TechAmerica is involved in standard.

The Electromagnetic Compatibility (EMC) Committee (formally known as G-46) deals with the system-oriented discipline that ensures electromagnetic compatibility in electronics design. The Committee develops technical criteria and procedures to guide the design engineer. Its work also includes spectrum management and conservation; secure communications; and electromagnetic emissions, susceptibility, control, and characterization.

The EMC Committee was established to provide an industry/user position on government specifications, regulations, and standards. Participation has expanded to include G-46 representation on the various committees drafting government specifications and standards. For example, G-46 participated on the working committees for MIL-STD-464A and MIL-STD-461E and provided update recommendations to MIL-STD-461F. The scope of G-46 activities has expanded to foster and facilitate the EMC discipline for the benefit of TechAmerica member companies.

Committee activities include spectrum management and conservation; personnel safety; and health care electronics design, usage and installation in terms of regulated and non-regulated electromagnetic (EM) emissions and immunity. Inter- and intra-environmental areas as they affect systems, subsystems and equipment, subassemblies, and components are also areas of concern. In addition to other activities, committees:

- Review, assess, advise, and coordinate related activities of organizations/individuals in government, industry, and technical societies.
- Assure that EMC legislation, regulations, specifications, standards, requirements, and evaluation procedures are adequate for procurement and application.
- Assure that EMC legislation, regulations, specifications, standards, requirements, and evaluation procedures are harmonized with their commercial counterparts to the maximum extent practical for procurement and application.

- Propose and recommend action and provide support to other organizations, as deemed desirable.
- Coordinate and promulgate information to facilitate advancement of the state-of-the-art.

Additional information on TechAmerica and the EMC Committee (G-46) can be obtained at (703) 284-5315, phyllis.call@techamerica.org, or via the GEIA website at <http://www.geia.org>.

Society of Automotive Engineers

Committee AE-4, Committee Headquarters:

Society of Automotive Engineers
400 Commonwealth Drive
Warrendale, PA 15096-0001
Phone: (724) 776-4841

SAE International is a professional society of engineers dedicated to a broad spectrum of engineering disciplines within the aerospace and automotive fields. Under the SAE Aerospace Council, technical standards committees address disciplines ranging from electrical power to multiplex signal characteristics—and from fiber optic data transmission to electromagnetic compatibility. The many elements of EMC are handled by SAE Committee AE-4, Electromagnetic Compatibility, which was organized in 1942 under the Aerospace Council. The committee is composed of technically qualified members, liaison members, and consultants—all of whom are responsible for writing standards on electromagnetic compatibility.

Committee AE-4 provides assistance to the technical community through standardization, improved design and testing methodology, and technical forums for the resolution of mutual problems. Engineering standards, specifications, and technical reports are developed by the Committee and are issued by the Society for industry and governments worldwide. Objectives of Committee AE-4 are to advance the state of technology, to stabilize existing technology, to obtain a uniformity of EMC requirements among government agencies, and to further the interests of the EMC technical community. The theme of “design before the fact” for EMC is a guiding concept. Special attention is given to maintenance of EMI control requirements consistent with the rapidly advancing state-of-the-art.

The following is a partial list of documents that have been issued to assist in implementing SAE objectives. For a complete list, visit the SAE website at www.sae.org or call SAE Customer Service at (724) 776-4841.

AEROSPACE RECOMMENDED PRACTICES (ARPS)

ARP 935A	Control Plan/Technical Construction File
ARP 936A	Capacitor, 10 mF for EMI Measurements
ARP 958C	Electromagnetic Interference Measurement Antennas, Standard Calibration Method
ARP 958D	Electromagnetic Interference Measurement Antennas

- nas, Standard Calibration Method
- ARP 1172 Filters, Conventional, EMI Reduction, Specifications for
- ARP 1173 Test Methods for EMI Gasketing
- ARP 1267 EMI Measurement of Impulse Generators, Standard Calibration Requirements and Techniques
- ARP 1481A Corrosion Control and Electrical Conductivity in Enclosure Design
- ARP 1705 Coaxial Test Procedure to Measure the RF Shielding Characteristics of EMC Gasket Materials
- ARP 1870 Aerospace Systems Electrical Bonding and Grounding for Electromagnetic Compatibility and Safety
- ARP 1972 Recommended Practices and Procedures for EMC Testing
- ARP 4043A Flightline Bonding and Grounding of Aircraft
- ARP 4242 Electromagnetic Compatibility Control Requirements, Systems
- ARP 4244 Recommended Insertion Loss Test Methods for EMI Power Line Filters

AEROSPACE INFORMATION REPORTS (AIRS)

- AIR 1147 EMI on Aircraft from Jet Engine Charging
- AIR 1209 Construction and Calibration of Parallel-Plate Transmission Lines for EMI Susceptibility Testing
- AIR 1221 EMC System Design Checklist
- AIR 1255 Spectrum Analyzers for EMI Measurements
- AIR 1394A Cabling Guidelines for Electromagnetic Compatibility
- AIR 1404 DC Resistivity vs. RF Impedance of EMI Gaskets
- AIR 1423 EMC on Gas Turbine Engines for Aircraft Propulsion
- AIR 1425A Methods of Achieving EMC of Gas Turbine Engine Accessories, for Self-Propelled Vehicles
- AIR 1499 Recommendations for Commercial EMC Susceptibility Requirements
- AIR 1662 Minimization of Electrostatic Hazards in Aircraft Fuel Systems
- AIR 1700A Upper Frequency Measurement Boundary for Evaluation of Shielding Effectiveness in Cylindrical Systems
- AIR 4079 Procedure for Digitized Method of Spark Energy Measurement

SAE AE-4 ELECTROMAGNETIC ENVIRONMENTAL EFFECTS (E3 OR EMC) COMMITTEE

The SAE AE-4 E3 Committee provides a technical, coordinating, and advisory function in the field of E3. The focus is on problem areas in which committee expertise can be effectively applied at the national and international levels. Electrical and electronic accessories are studied for compatibility within systems and with various communications media. Engineering standards, specifications, and technical reports are developed and are issued for the general information of industry and government.

In the past, subcommittees have included AE-4R, Aircraft Radiated Environments, and AE-4H, High Power RF Simulators and Effects. AE-4 E3 holds national meetings in

conjunction with the IEEE EMC Society Symposium, usually held in August at various locations. Additional information about meetings or more specific information on the activities of the Committee can be obtained by contacting:

Dorothy Lloyd

Aerospace Standards Specialist

Society of Automotive Engineers

400 Commonwealth Drive

Warrendale, PA 15096-0001

Phone: (724) 776-4841

dlloyd@sae.org

or the Chairman, Gary Fenical, gfenical@lairdtech.com.

Visit the SAE's Technical Standards Committee Forum website at <http://forums@sae.org>.

iNARTE

iNARTE, Inc. (The International Association for Radio, and Telecommunications and Electromagnetics, Inc.) was founded as a non-profit membership/certification organization in 1982. With the advent of deregulation and the Federal Communications Commission's "encouragement/urging" private industry to establish certification standards to fill the licensing void, iNARTE initiated and developed a comprehensive certification program for telecommunications engineers and technicians.

In 1988, a Command of the United States Navy, seeking a credible and respected certification entity, selected iNARTE as the administrative agent for the certification of engineers and technicians in the field of electromagnetic compatibility (EMC).

In 1993, iNARTE, certified by the Federal Communications Commission (FCC) as a Commercial Operators License Examination Manager (COLE Manager), was authorized to administer all examination elements for FCC licensure (formally an FCC responsibility).

In 1994, the ESD Association selected NARTE to implement and administer a certification program for Electrostatic Discharge Control Engineers and Technicians.

During 1997, two nations, China and Japan, requested iNARTE assistance in the establishment of specific in-country certification programs comparable to and able to meet iNARTE certification standards.

In 2000, iNARTE established the Unlicensed Wireless Systems Installer certification to identify fully qualified design and installation personnel. This certification accredits professionals who design and install wireless systems that do not require a license from the FCC—including information systems, security systems, and transportation systems.

In 2001, iNARTE developed an Agreement with the IEEE EMC Society for the co-promotion of awareness and education in EMC/EMI fields. Today the EMC Society is the keeper of the body of knowledge from which the iNARTE examinations are derived.

In 2003 iNARTE, together with specialist partners, developed the Product Safety certification program. The Product

Safety program accredits professionals who use hazard-based analysis to identify and develop solutions to eliminate or minimize safety hazards. In 2004 iNARTE signed an Agreement with the IEEE Product Safety Engineering Society, PSES, to co-promote awareness and education in Product Safety. Today, technical experts within the PSES assist iNARTE in the development of the examination question pools.

In 2006 iNARTE executed Agreement with ANSI ASC 63, the Accredited Standards Committee on EMC, for the purposes of joint cooperation and promotion in education and technical achievement in EMC engineering.

By 2007, the global interest and participation in iNARTE Certification programs had resulted in almost one quarter of members being from overseas countries. In recognition of this, the iNARTE Board of Directors voted unanimously to change the Association name to the, "International Association for Radio, Telecommunications and Electromagnetics, iNARTE."

As iNARTE, an agreement of mutual support and cooperation was signed with the ESD Association in 2007. The ESDA will assist iNARTE in formulating and maintaining the question pools from which certification examinations are derived.

Website: www.inarte.org

ACIL—The American Council of Independent Laboratories

The American Council of Independent Laboratories

(ACIL) is the trade association representing independent, commercial engineering, and scientific laboratory, testing, consulting, product certifying, and R&D firms; manufacturers' laboratories; related non-profit organizations; and consultants and suppliers to the industry. The organization was founded in 1937. All ACIL activities focus on its mission: to enhance members' success by providing advocacy, education, services, and mutual support and by promoting ethics, objectivity, independence, and free enterprise.

ACIL is a voluntary, non-profit membership organization. Programs are determined by members, administered by an elected Board of Directors, and supported by a professional staff operating from headquarters in Washington, D.C.

ACIL'S CONFORMITY ASSESSMENT SECTION

ACIL's Conformity Assessment Section consists of firms with wide and varied interests, all performing testing, listing, or labeling in accordance with applicable safety and performance standards, and/or materials testing and resolution of product and structural problems. Several committees have evolved within the Section to meet the needs of its diverse membership, including the EMC Committee, the U.S. Council of EMC Laboratories, and the Third-Party Product Certifiers Committee. In January 2005, the Section sponsored a booth at the Consumer Electronics Show that advocated the advantages of independent third-party test-

ing and the capabilities of ACIL member EMC laboratories.

ACIL'S EMC COMMITTEE

ACIL's EMC Committee was established in 1996 to address the common concerns of the ACIL EMC community. The Committee sponsors educational sessions at ACIL meetings that include both technical and policy issues such as mutual recognition agreements (MRAs). The Committee updates members on the latest developments, upcoming requirements, and activities in the field—both domestic and international.

In January 2002, ACIL published a 143-page document, Technical Criteria for the Accreditation of Electromagnetic Compatibility (EMC) and Radio Testing Laboratories, a checklist to assist both assessors and laboratories.

The Committee also formed the U.S. Council of EMC Laboratories (USCEL) in an effort to aid U.S. laboratories in addressing technical issues arising from the U.S./EU MRA and other global concerns. As the USCEL Secretariat, ACIL provides staff and supports volunteers active in this important area.

Over the past several years, ACIL has administered round robin proficiency testing programs with two artifacts; allowing laboratories to make both AC line conducted and radiated emissions measurements over the frequency range of 0.15–30 MHz and 30 MHz–1 GHz, respectively. While continuing the round robins in the frequencies noted above, ACIL has launched another round robin with a new test artifact. This artifact will allow participating laboratories to demonstrate proficiency for radiated emissions measurements in the frequency range of 1–18 GHz. Emissions measurements above 1 GHz are becoming increasingly common with the advent of fast processors and wireless devices in the 2.4- and 5-GHz bands.

ACIL also was instrumental in the formation of the Telecommunication Certification Body Council (TCBC). New rules establishing TCBs were adopted by the FCC in December 1998, providing more options for manufacturers—they can now choose to have their product certified by either the FCC or a private certification body (TCB). A TCB may approve equipment subject to certification (e.g., transmitters, telecom terminal equipment, or scanning receivers). The TCB Council addresses the specific concerns of the TCB community and all constituent bodies are permitted to participate.

U.S. PRODUCT CERTIFIERS

Key U.S. product certifiers are ACIL members and are reaping many benefits, such as participation in the ACIL Third-Party Product Certifiers Committee (3P²C²). This Committee provides a forum for members to discuss and to act upon various issues of common interest. This committee formed the American Council for Electrical Safety to serve as a forum among testing laboratories, regulators, and electrical inspectors.

Website: www.acil.org

GOVERNMENT DIRECTORY

The following is a list of the principal U.S., NATO and Canadian Government personnel known to be involved in the interference technology field. This list is based upon best available data at the time of publication. Additions, deletions and corrections for any facility may be updated at any time by e-mailing your changes to slong@interferencetechnology.com.

DEPARTMENT OF DEFENSE

Defense Spectrum Organization

DSD Director: Ms. Paige R. Atkins..... (703) 325-2567
Paige.Atkins@disa.mil
DSD Dep Dir: Mr. Ralph Puckett..... (703) 325-2874
Ralph.Puckett@disa.mil

Strategic Planning Office (SPO)

SPO Director: Mr. Steven A. Molina (703) 325-0435
Steven.Molina@disa.mil
Internat'l Team Lead: Mr. Chris Hofer... (703) 325-2876
EST Team Lead: Ms. Mary Lin..... (703) 325-0136
National Team Lead: Mr. Dan O'Neill ... (703) 325-2606

Joint Spectrum Center (JSC)

2004 Turbot Landing, Annapolis, MD 21402-5064
Tel: (410) 293-4957, Fax: (410) 293-2631

Commander, JSC (J00):

COL John J. HICKEY Jr., USA (410) 293-2450
John.Hickey@jsc.mil
Commander's Group: commander@jsc.mil

Technical Director (J01):

Mr. Mike Williams (410) 293-2457
mike.williams@jsc.mil

Executive Officer (J02):

CDR Robert "Jeff" Lamont, USN (410) 293-2452
Jeff.Lamont@jsc.mil

Operations Division (J3):

Chief: LTC Kevin T. Laughlin..... (410) 293-9813
Kevin.Laughlin@jsc.mil
Senior Engineer: Mr. Robert Lynch (410) 293-9816
robert.lynch@jsc.mil

RD&A Division (J5):

Mr. Robert Schneider (410) 293-4958
robert.schneider@jsc.mil
Senior Engineer: Mr. Marcus Shellman, Jr.
..... (410) 293-4959
marcus.shellman@jsc.mil
Team Lead: Mr. Matthew Grenis (410) 293-9264
matthew.grenis@jsc.mil
R&D Team Lead: Mr. Serey Thai (410) 293-9263
Serey.Thai@jsc.mil

Spectrum Management Information Technology Division (J6):

Acting Chief: Mr. Joseph R. Whitworth.....
..... (410) 293-9822

Plans and Resources Division (J7):

Chief: Mrs. Joanne F. Sykes (410) 293-2356
joanne.sykes@jsc.mil

Applied Engineering Division (J8):

Chief: Aaron Leong, Lt Col, USAF..... (410) 293-2682
Aaron.Leong@jsc.mil
Senior Engineer: Mr. Irving Mager, Jr. (J8)
..... (410) 293-2103
irving.mager@jsc.mil
Chief, DSRMA: Mr. Ted Grove..... (410) 293-2222

Joint Frequency Management and Spectrum Engineering Office, Atlantic (JFMO LANT)

Director JFMO LANT (USJFCOM/J63)
1562 Mitscher Ave., Ste. 200
Norfolk, VA 23551-2488
Tel.: (757) 836-8006
Fax: (757) 836-8022

UNITED STATES AIR FORCE

Aeronautical Systems Center (ASC)

ASC/ENAC

2145 Monahan Way
Wright-Patterson Air Force Base, OH 45433-7101
Fax: (937) 255-5305
E3 Technical Advisor
Mr. Manny Rodriguez (937) 255-6957
manuel.rodriguez@wpafb.af.mil

EMI/EMC Tech Expert

Mr. Joseph M. DeBoy, (937) 255-6995
joseph.deboy@wpafb.af.mil

EMI/EMC Engineer

Mr. Brian M. Lezanic (937) 255-9051
brian.lezanic@wpafb.af.mil

Aeronautical Systems Center (ASC)

ASC/ENAC

2145 Monahan Way
Wright-Patterson Air Force Base, OH 45433-7017
Fax: (937) 255-5305
Electromagnetic Environmental Effects (E3) Engineer
Mr. Jose Pabon Soto (937) 255-7676
jose.pabon-soto@wpafb.af.mil

Aeronautical Systems Center (ASC)

ASC/WKE

2590 Loop Rd. West
Wright-Patterson Air Force base, OH 45433-7142
Fax: (937) 255-7749
Electromagnetic Environmental Effects (E3) Engineer
Ms. Natalia Bartholomew (937) 255-3451
natalia.bartholomew@wpafb.af.mil

Aeronautical Systems Center (ASC)

312/326 AE SW (Fighter Bomber Wing) 702 AE SG (B-2)

Air Force Research Laboratory Headquarters
Bldg 15 Room 225
1864 Fourth Street
WPAFB, OH 45433-7132
Mr. Joe Harrington (937) 255-0844
joseph.harrington@wpafb.af.mil

Aeronautical Systems Center (ASC)

312/326 AE SW (Fighter Bomber Wing) 702 AE SG (B-2)

2690 C St., B556
Wright-Patterson AFB, OH 45433-7424
Dr. Phil Beccue..... (937) 255-6881
Philip.Beccue@wpafb.af.mil

Aeronautical Systems Center (ASC)

312/326 AE SW (Fighter Bomber Wing) 651 AE SS (B-52)

2690 C St., B556
Wright-Patterson AFB, OH 45433-7424
FAX (937) 656-4621
Mr. Jeremy Burns (937) 255-7025
jeremy.burns@wpafb.af.mil

HQ Air Force Material Command (AFMC)

AFMC/EN P

Bldg. 262/Rm N145/Post116D
Wright-Patterson AFB, Ohio 45433
Fax: (937) 656-4183
Mr. John S. Welch (937) 255-0651

john.welch@wpafb.af.mil

Aeronautical Systems Center (ASC)

516 AE SW (Mobility)

836 AE SG (Tankers)

2530 Loop Road West,
Wright-Patterson AFB, Ohio 45433
Mr. Robert Rosengarten (937) 255-3451
Robert.Rosengarten@wpafb.af.mil

Air Force Research Laboratory, Sensors

Directorate

AFRL/RVWD

2241 Avionics Circle
Bldg 620, Rm 1D6106
Wright-Patterson Air Force Base, OH 45433
EMI Laboratory
Fax: (937) 656-9047
Mr. Steven Coffman..... (937) 528-8673
steven.coffman.ctr@wpafb.af.mil

Aeronautical Systems Center

Reconnaissance Systems Wing

303 AE SG (Global Hawk)

2640 Loop Road West
Wright-Patterson Air Force Base, OH 45433-7106
Mr. Dave Osborn..... (937) 255-7437
david.osborn@wpafb.af.mil

Air Force Research Laboratory, Sensors

Directorate

AFRL/RYWD

2241 Avionics Circle
Bldg 620, Rm 1D6106
Wright-Patterson Air Force Base, OH 45433
EMI Laboratory
Fax: (937) 656-9047
Mr. John Zentner..... (937) 528-8677
john.zentner.ctr@wpafb.af.mil

Air Force Space Command (AFSPC)

85th Engineering Installation Squadron

85 EIS/SCYM

670 Maltby Hall Drive, Ste.234
Keesler AFB, MS 39534-2633
85.eis.scym@keesler.af.mil
Specialized Engineering Flight:
Mr. George R. McNeer, SCY (228) 377-1037
Electromagnetics Section Chief:
Mr. Frederick G. Blache, SCYM (228) 377-3926
frederick.blache@us.af.mil
E3 Engineers:
Mr. Randal Blanchard, SCYT (228) 377-1068
randal.blanchard@us.af.mil
Captain Micah Coplan..... (228) 377-1035
micah.coplan@us.af.mil
Ms. Kristen M. Corrigan (228) 377-1073
kristen.corrigan@us.af.mil
Mr. Edward Crum, SCYM (228) 377-1096
edward.crum@us.af.mil
Mr. Stephen L. Dabney (228) 377-1074
stephen.dabney@us.af.mil
Mr. Tim O. Hillman (228) 377-1278
timothy.hillman@us.af.mil
Mr. Justin L. Johnston (228) 377-3041
justin.johnston.4@us.af.mil
Mr. Carlton L. Jones..... (228) 377-1088
carlton.jones@us.af.mil

Mr. James W Laycock.....(288) 377-1035
james.laycock@us.af.mil
Mr. Tom Lipski(228) 377-1084
thomas.lipski@us.af.mil
Captain Arris Pineda(228) 377-1126
arris.pineda@us.af.mil
Mr. Alton J. Richards III(228) 377-1079
alton.richards@us.af.mil
Captain Jason R. Seyba.....(228) 377-1085
jason.seyba@us.af.mil
Mr. Gregory P. Smith(228) 377-1083
gregory.smith.7@us.af.mil
Mr. Jessie Thomas III.....(228) 377-4601
jessie.thomas.2@us.af.mil
Mr. Phi D. Tran(228) 377-1062
phi.tran@us.af.mil
Mr. Truong X. Vu(228) 377-1866
truong.vu@us.af.mil
Mr. Brandon Walker(228) 377-1048
brandon.walker.1@us.af.mil
Mr. Robert (Nick) Wilson, Sr. Electronics Engineer
.....(228) 377-1047
robert.wilson.6@us.af.mil

UNITED STATES ARMY

U. S. Army Research, Development and Engineering Command (RDECOM)

Attn.: AMSRD-AAR-AEP-F

Bldg. 3208

Picatinny Arsenal, NJ 07806-5000

Fax: (973) 724-3025

Mr. Tom Crowley, Supvr.(973) 724-5678
thomas.m.crowley@us.army.mil
Mr. Derrick Coppin, Proj. Engr.(973) 724-4871
derrick.coppin@us.army.mil
Mr. Daniel Gutierrez, Sr. Proj. Engr.(973) 724-4667
daniel.gutierrez@us.army.mil
Mr. Paul Lee, Proj. Engr.(973) 724-4584/4667
paul.m.lee@us.army.mil

Army Research, Development, and Engineering Command (RDECOM)

Attn.: RDMR-AES-E3

Building 4488

Redstone Arsenal, AL 35898-5000

Fax: (256) 313-3194

E3 for Army Aircraft Airworthiness

E3 Branch Chief:

Mr. Dave Lewey.....(256) 313-8464
dave.lewey@us.army.mil

E3 Team Lead, Attack/Recon/Cargo Team:

Ms. Karen Compton(256) 313-8437
karen.compton@us.army.mil

E3 Team Lead, Utility/Fixed Wing/SOA Team:

Mr. Duane Driver(256) 313-8447
duane.driver@us.army.mil

Mr. Dale Heber(256) 313-2229
dale.heber@us.army.mil

Mr. Bruce Hildebrandt.....(256) 313-8457
bruce.hildebrandt@us.army.mil

Mr. Elliot Croom.....(256)842-5387
Elliot.croom@amrdec.army.mil

Mr. Abner Merriweather(256) 313-8470
abner.merriweather@us.army.mil

Mr. Brian Smith, iNCE, iNCT.....(256) 313-8484
brian.smith42@us.army.mil

Mr. John Trp.....(256) 313-3148
john.trp@us.army.mil

Mr. Mike Dreyer(256) 313-6384
michael.dreyer@us.army.mil

Mr. Dan Hinton(256) 313-8497
daniel.w.hinton@us.army.mil

Mr. David Alan Landrith.....(256)313-9102
david.landrith@amrdec.army.mil

Mr. Roy Lawson.....(256) 313-8454
roy.lawson@us.army.mil

Mr. Chris Myers(256) 842-3197
Christopher.myers@amrdec.army.mil

Mr. Thad Paone(256) 842-1387
Thad.paone@us.army.mil

Attn.: AMSAM-RD-MG-SD

SC Functions

Mr. Dave Smith.....(256) 876-1688
wayne.d.smith2@us.army.mil

Army Test and Evaluation Command (ATEC)

United States Army Aberdeen Test Center (ATC)

Electromagnetic Interference Test Facility (EMITF)

Attn.: TEDT-AT-C4

400 Collieran Road, Building 456

Aberdeen Proving Ground, MD 21005-5059

Fax: (410) 278-0579

EMITF Supervisor:

Mr. Michael C. Geiger.....(410) 278-2598
michael.c.geiger.civ@mail.mil

Senior Electrical Engineer:

Mr. Clinton Sienkiewicz(410) 278-9340
clifton.j.sienkiewicz.civ@mail.mil

Electrical Engineer

Mr. Antoine Stalbert(410) 278-9339
Antoine.j.stalbert.ctr@mail.mil

Electronic Technicians:

Mr. Duane Buono.....(410) 278-9340
duane.buono.ctr@mail.mil

Mr. Andrew Bell(410) 278-9340
Andrew.j.bell.ctr@mail.mil

Mr. Emmanuel Hammett.....(410) 278-9340
Emmanuel.hammett.ctr@mail.mil

Mr. Mark Connor(410) 278-9340
Mark.j.connor3.ctr@mail.mil

Christopher Dennison(410) 278-9340
Christopher.r.dennison.ctr@mail.mil

JR Gildeleon.....(410) 278-9339
john.r.gildeleon.ctr@mail.mil

Mr. Todd Holman(410) 278-9340
richard.t.holman.ctr@mail.mil

Mr. Harry Giles(410) 278-9340
Harry.j.giles.ctr@mail.mil

Mr. Brian Savage.....(410) 278-4851
brian.c.savage.ctr@mail.mil

Mr. Dennis Wanzer.....(410) 278-9340
dennis.r.wanzer.ctr@mail.mil

Army Center for Health Promotion & Preventive Medicine (CDR USACHPPM)

Radiofrequency/Ultrasound Program

Attn.: MCHB-TS-ORF

5158 Blackhawk Road

Aberdeen Proving Ground, MD 21010-5403

Mr. John J. DeFrank(410) 436-3353

Bureau of Medicine and Surgery (M3F72)

2300 E. St., N.W.

Washington, DC 20372-5300

Fax: (202) 762-0931

LJTG Jamaal Whitmore(202) 762-3448
jawhitmore@us.med.navy.mil

Army Engineer Research and Development Center

Construction Engineering Research Laboratory

Attn.: CEERD-CF-F

P.O. Box 9005

Champaign, IL 61826-9005

Dr. William J. Croisant.....(217) 373-3496
william.j.croisant@erd.c.usace.army.mil

Army Electronic Proving Ground

Test Engineering Directorate

Laboratory Division

Attn.: TEDT-EP-TEL

Fort Huachuca, AZ 85613-7110

Div. Chief Mr. Rafael Anton(520) 538- 4916
rafael.anton@us.army.mil

E3 Test Facility/Blacktail Canyon

Technical Lead: Mr. Johnny Douglas ... (520) 533-5819
johnny.douglas@us.army.mil

Mr. James Smith(520) 538-5188
james.a.smith4@us.army.mil

Ms. Rachel Blake.....(520) 538-2818
rachel.m.blake@us.army.mil

Mr. David Seitz(520) 533-5819
david.seitz3@us.army.mil

Antenna Test Facility

Technical Lead: Mr. Doug Kremer (520) 533-8170
douglas.kremer@us.army.mil

Army Intelligence and Security Command

G-4, Technical Support Division

Attn.: IALO-T

8825 Beulah St.

Ft. Belvoir, VA 22060-5246

Tel.: (703) 428-4479

Fax: (703) 428-4911

Ms. Anne Bilgihan

anne.bilgihan@us.army.mil

Army Nuclear and Chemical Agency (USANCA)

7150 Heller Loop, Ste. 101

Springfield, VA 22150-3198

Mr. R. Pfeffer (703) 806-7862

Army Test and Evaluation Command (ATEC) United

States Army Aberdeen Test Center (ATC)

Electromagnetic Interference Test Facility (EMITF)

Attn.: CSTE-DTC-AT-SL-V-EMI

400 Collieran Road, Building 456

Aberdeen Proving Ground, MD 21005-5059

Fax: (410) 278-0579

EMITF Supervisor:

Mr. Michael C. Geiger(410) 278-2598
michael.c.geiger@us.army.mil

Electrical Engineer:

Mr. Clinton Sienkiewicz(410) 278-9340
clifton.sienkiewicz@us.army.mil

Electronic Technicians:

Mr. Duane Buono.....(410) 278-9340
duane.buono@us.army.mil

Mr. Keith Deitz.....(410) 278-9339
keith.deitz@us.army.mil

Mr. Christopher Dennison.....(410) 278-9340
c.dennison@us.army.mil

Mr. JR Gildeleon.....(410) 278-9339
john.gildeleon@us.army.mil

Mr. Todd Holman(410) 278-9340
richard.t.holman@us.army.mil

Mr. Tom Martin(410) 278-9340
thomas.j.martin@us.army.mil

Mr. Brian Savage.....(410) 278-4851
brian.c.savage@us.army.mil

Mr. Gary Stotts.....(410) 278-9340
gary.stotts@us.army.mil

Mr. Dennis Wanzer.....(410) 278-4832
dennis.wanzer@us.army.mil

Army Test and Evaluation Command (ATEC)

Survivability Division

Attn.: TEAE-SZN

Bldg. 1660, 1660 Jeb Stuart Road, Ft. Bliss, TX 79916-

6812, Fax: (915) 568-4404

Mr. Joe Reza(915) 568-6539
jose.reza@us.army.mil

White Sands Test Center

Attn.: TEDT-WSV-E (S Jesson)

Building 21225

White Sands Missile Range, NM 88002-5158

- Ms. Stephanie Jesson (575) 678-6107
Stephanie.s.jesson.civ@mail.mil
- Ms. Janet Danneman (575) 678-6307
Janet.danneman.civ@mail.mil
- Mr. Gustavo Sierra (575)-678-2038
Gustavo.I.sierra.civ@mail.mil
- Mr. John Chavarria (575) 678-1993
John.p.chavarria.civ@mail.mil

UNITED STATES MARINE CORPS

Marine Corps Operational Test and Evaluation Activity (MCOTEA)

3035 Barnett Ave., Quantico, VA 22134, Chief of Test (703) 432-0927, Marine Corps Systems Command (MCSC),

Attn.: Mr. Praful Bharucha (C4II/ACENG), 2000 Lester Street, Quantico, VA 22134-5010

E3 Control Program Sponsor

- Mr. Praful Bharucha (703) 432-3806
praful.bharucha@usmc.mil

UNITED STATES NAVY

MID-LANT Area Frequency Coordination Office

Naval Air Warfare Center Aircraft Division Code 5.2.2.2

23013 Cedar Point Road, Unit 4, Building 2118 Patuxent River, MD 20670-1183

Fax: (301) 342-1200

- Mr. Mikel R. Ryan (301) 342-1532
mikel.ryan@navy.mil

Naval Air Systems Command (NAVAIR)

Electromagnetic Environmental Effects (E3)

Division

AIR 4.1.13

48142 Shaw Road, Building 3197, Suite 1040 Patuxent River, MD 20670

- E3 Div. Hd.: Mr. Mike Squires (301) 342-1660
michael.squires@navy.mil

Naval Air Systems Command (NAVAIR)

Air Systems EMI Corrective Action Program (ASEMICAP)

- Ms. Angela Partin (301) 342-7813
angela.partin@navy.mil
- Mr. Steve Rhoten (301) 995-2712
steven.rhoten@navy.mil

E3 Aircraft Engineering Branch

AIR 4.1.13.1

- Br. Head: Mr. Ted Rothman (301) 342- 9223
theodore.rothman@navy.mil
- Ms. Carrol Basanez (301) 757-2451
carrol.basanez@navy.mil
- Mr. Paul Belusko (301) 757-2446
paul.belusko@navy.mil
- Mr. Jon Bergmann (301) 995-3832
jon.bergmann@navy.mil
- Mr. John Besanceney (301) 757-2445
john.besanceney@navy.mil
- Ms. Pamela Crispell (301) 342-8629
pamela.crispell@navy.mil
- Mr. Ken Deans (301) 757-2447
kenneth.deans@navy.mil
- Mr. William DePasquale (301) 757-6961
william.depasquale@navy.mil
- Mr. Travis Flanagan (301) 342-7771
travis.flanagan@navy.mil

- Mr. Frederick Heather (301) 342-6975
frederick.heather@navy.mil
- Mr. Reggie Hope (301) 342-6975
lionel.hope@navy.mil
- Mr. DJ Jardine (301) 757-2451
david.jardine@navy.mil
- Mr. Joe Kmetz (301) 757-2361
joseph.kmetz@navy.mil
- Mr. Gene Kuhn (301) 757-6545
gene.kuhn@navy.mil
- Mr. Jay Lees (301) 342-0350
jay.lees@navy.mil
- Mr. Jason Mackowiak (301) 342-8344
jason.mackowiak@navy.mil
- Mr. Felipe Nazario (301) 342-1662
felipe.nazario@navy.mil
- Ms. Jennifer Nguyen (301) 995-7671
jennifer.nguyen@navy.mil
- Mr. Luke Onachila (301) 757-2420
luke.onachila@navy.mil
- Mr. Steve Salisbury (301) 342-2255
steven.salisbury@navy.mil
- Mr. John Schultz (301) 757-2456
john.schultz@navy.mil
- Mr. Craig Simmons (301) 342-4907
craig.simmons@navy.mil
- Mr. Michael Skrabacz (301) 342-5805
michael.skrabacz@navy.mil
- Mr. Robert Tate (301) 342-8632
robert.d.tate1@navy.mil
- Mr. John Tonello (301) 342-2158
john.tonello@navy.mil
- Mr. Thierry Wandji (301) 342-3297
ketchiozo.wandji@navy.mil

NAVAL AIR WARFARE CENTER AIRCRAFT DIVISION

Electromagnetic Interference Lab, 5.4.4.9

Patuxent River, MD, Fax: (301) 342-5390

EMI Lab

- Branch Hd.: Mr. Lance Pearce (301) 342-0851
lance.pearce@navy.mil
- Mr. Kenneth Brezinski (301) 342-0848
kenneth.brezinski@navy.mil
- Mr. Tom Dennehey (301) 342-0832
thomas.dennehey@navy.mil
- Mr. Richard Harvan (301) 342-0847
richard.harvan@navy.mil
- Ms. Diane Kempf (301) 342-0850
diane.kempf@navy.mil
- Ms. Pam Lumsden (301) 342-0852
pamela.lumsden@navy.mil
- Mr. Patrick Mills (301) 995-4148
patrick.n.mills@navy.mil

NAVAIR Aircraft Division, Lakehurst

AIR 4.1.13.1

Hwy. 547, Bldg. 355-2, Lakehurst, NJ 08733-5112

Fax: (732) 323-1844

EMI Lab

- Mr. Richard Del Conte (732) 323-2085
richard.delconte@navy.mil
- Mr. David Fetzer (732) 323-2085
david.fetzer@navy.mil

NAVAIR Weapons E3 Engineering

China Lake Site

41M200D

1900 Knox Road, Stop 6622, China Lake, CA 93555-6001

Fax: (760) 939-1065

- Br. Head: Mr. John Brandt (760) 939-1625
john.brandt@navy.mil
- Mr. Chinh Dang (760) 939-9435
chinh.dang@navy.mil
- Mr. Luke Dawson (760) 939-7565
luke.dawson@navy.mil

- Mr. Fernando Garcia (760) 495-2622
fernando.m.garcia1@navy.mil
- Ms. Patricia Siegel (760) 939-4637
patricia.siegel@navy.mil
- Mr. Stephen Tanner (760) 939-4669
stephen.tanner@navy.mil
- Mr. Gabriel Waliser (760) 939-8997
gabriel.waliser@navy.mil

NAVAIR Weapons Targets Division

Point Mugu Site

41M200E

575 I Ave., Ste. 1, Point Mugu, CA 93042-5049

Fax: (805) 989-3826

- Ld. Engr.: Mr. Les Jue (805) 989-7884
leslie.jue@navy.mil

Naval Air Systems Command (NAVAIR)

Orlando 4.1.M

12350 Research Parkway, Bldg Deflores Floor 3 Rm 3C6H Orlando, FL 32826

- Mr. John Mock (407) 380-4476
john.mock@navy.mil

NAVAIR, Aircraft Division

48202 Standley Rd., Unit 5, Ste. 3B, Patuxent River, MD 20670-1910

Integrated Battlespace Simulation & Test Department AIR 5.4.4 ICE

Fax: (301) 342-6982

- Div. Head: Mr. Kurt Sebacher (301) 342-1664
Kurt.Sebacher@navy.mil
- Dep. Div. Head: Mr. Brian Woode (301) 995-2331
brian.woode@navy.mil
- Mr. Vern Panei (301) 342-6150
vern.panei@navy.mil

Electromagnetic Compatibility Branch (5.4.4.5 EMC)

- Hd.: Mr. Mark Mallory (301) 342-1663
mark.mallory@navy.mil
- Mr. Paul Achteflik (301) 342-7820
paul.achteflik@navy.mil
- Mr. Omar Ali (301) 342-7814
omar.ali@navy.mil
- Mr. Rich Andrusko (301) 342-7810
richard.andrusko@navy.mil
- Mr. Mike Clelland (301) 342-8605
michael.clelland@navy.mil
- Mr. Russ Danaher (301) 342-0020
russell.danaher@navy.mil
- Mr. John Finley (301) 342-4855
john.finley@navy.mil
- Mr. Xuyun Gan (301) 342-8725
xuyun.gan@navy.mil
- Mr. Scott Graham (301) 342-7809
scott.graham@navy.mil
- Mr. Matt Griffith (301) 757-9414
matt.griffith@navy.mil
- Mr. Remash Guyah (301) 342-8681
remash.guyah@navy.mil
- Mr. Scott Halt (301) 342-7575
scott.halt@navy.mil
- Mr. Ryan Hanks (301) 342-7785
ryan.hanks@navy.mil
- Mr. Danny Johnson (301) 342-7811
daniel.r.johnson@navy.mil
- Mr. James Lewis (301) 342-5845
james.g.lewis@navy.mil
- Ms. Alexis Martin (301) 342-0199
alexis.martin@navy.mil
- Mr. Jeffrey Miller (301) 757-0019
jeffrey.c.miller@navy.mil
- Mr. Tim Moynihan (301) 342-7846
timothy.moynihan@navy.mil
- Mr. Mike Nahaj (301) 342-3554
michael.nahaj@navy.mil
- Mr. Sam Niebauer (301) 757-0016

samuel.niebauer@navy.mil
 Mr. Donn Rushing(301) 342-7848
 donn.rushing@navy.mil
 Mr. Chris Theofolis(301) 342-1667
 chris.theofolis@navy.mil
 Ms. Virginia Wines (Sec.)(301)757-2507
 virginia.wines@navy.mil
 Electromagnetic Environments (EME) Branch
 AIR 5.4.4.6 EME, Fax: (301)757-3611 (Bldg. 2105)
 (301) 342-3786 (Bldg. 2100)
 Branch Hd.: Mr. Alan Mazuc (301) 757-3609
 alan.mazuc@navy.mil
 Mr. Dave Brown(301) 342-4597
 dave.a.brown@navy.mil
 Mr. John Crim (301) 757-3612
 john.crim@navy.mil
 Mr. Fabrizio Donis (301) 757-3604
 fabrizio.donis@navy.mil
 Mr. Jack Farren (301) 342-0507
 jack.farren@navy.mil
 Ms. Jack Faulkner (301) 995-2350
 jack.faulkner@navy.mil
 Mr. Miikka Holso (301) 757-3604
 miikka.holso@navy.mil
 Mr. Charles Joseph (301) 757-3608
 charles.joseph@navy.mil
 Mr. Bruce McClure (301) 342-0511
 bruce.mcclure1@navy.mil
 Mr. Mike Orloske (301) 757-3604
 mark.orloske@navy.mil
 Mr. Fulton Preston (301) 342-6979
 fulton.l.preston@navy.mil
 Mr. Mike Whitaker (301) 757-3604
 mike.whitaker@navy.mil
 Aircraft Information Security (TEMPEST) Branch
 AIR 5.4.4.7 TEMPEST, Fax: (301)342-4593
 Branch Hd.: Ms. Margaret Orr (301) 995-2433
 margaret.orr@navy.mil
 Mr. Scott Anderson (301) 342-6066
 scott.t.anderson@navy.mil
 Mr. Tom Dorrie (301) 342-6065
 thomas.dorrie@navy.mil
 Mr. Dan Lemanski (301) 342-6086
 daniel.lemanski@navy.mil
 Mr. Jimmy Lyon (301) 342-6129
 james.lyon@navy.mil
 Ms. Kim Wooden (301) 342-2194
 kimberly.wooden@navy.mil

Naval Air Warfare Center Training Systems Division (NAWCTSD)

Code 6.7.2.3

12350 Research Parkway, Orlando, FL 32826-3275
 Space and Naval Warfare Systems Center, Charleston
 (SPAWAR SYSCEN, Charleston)
 P.O. Box 190022
 North Charleston, SC 29419-9022
 Fax: (843) 218-4238
 Electromagnetic Environmental Effects (E3)
 Branch, Code 5610
 Branch Hd.: Mr. Wayne Lutzen (843) 218-5723
 Wayne.lutzen@navy.mil
 E3 Engineers
 Reco Baker (843) 218-3988
 reco.baker@navy.mil
 Mr. Frederic Duffy(843) 218-4363
 frederic.duffy@navy.mil
 Mr. Michael Hanna(843) 218-4039
 michael.a.hanna@navy.mil
 Mr. Guillermo Leiva (843) 218-7129
 guillermo.leiva@navy.mil
 Mr. Thomas Sessions(843) 218-6331
 thomas.sessions@navy.mil

Space and Naval Warfare Systems Center Pacific, Pacific C4ISR Department (SSC PAC, PAC C4ISR DEPT)

2293 Victor Wharf Access Road, Pearl City, HI 96782-3356
 Fax: (808) 474-5511
 Ms. Candice Saka (808) 471-4028
 candice.saka@navy.mil
 Mr. Jack Munechika (808) 471-1976
 jack.munechika@navy.mil
 Mr. Randy Yamada (808) 474-6061
 randy.yamada@navy.mil
 Mr. Lloyd Hayashida (808) 474-1967
 lloyd.hayashida@navy.mil
 Mr. Laine Murakami (808) 471-0366
 laine.murakami@navy.mil

SPAWAR Systems Center - Pacific (SSC-Pacific)

53560 Hull St., San Diego, CA 92152-5001
 Fax: (619) 553-3791
 Applied Electromagnetics Branch, Code 5541
 Branch Hd.: Dr. John Meloling (619) 553-2134
 john.meloling@navy.mil
 Mr. Jeffrey C. Allen (619) 553-6566
 jeffrey.allen@navy.mil
 Ms. Carol Becker (619) 553-1033
 carol.becker@navy.mil
 Mr. David C. Dawson (619) 553-4075
 david.c.dawson@navy.mil
 Mr. David Hurdsmen (619) 553-4261
 david.hurdsmen@navy.mil
 Mr. Lance Koyama (619) 553-3784
 lance.koyama@navy.mil
 Mr. Ahn Lee (619) 553-3426
 ahn.lee@navy.mil
 Mr. P. Michael McGinnis (619) 553-5092
 mike.mcginnis@navy.mil
 Ms. Nazia Mozaffar (619) 553-2593
 nazia.mozaffar@navy.mil
 Mr. Rick Nielsen (619) 553-6015
 rick.nielsen@navy.mil
 Ms. Jeanne Rockway (619) 553-3886
 jeanne.rockway@navy.mil
 Mr. Kianoush Rouzbehani (619) 553-3134
 kian.rouzbehani@navy.mil
 Raquel Sanchez-Karem (619) 553-5876
 raquel.sanchez-karem@navy.mil
 Ricardo Santoyo-Mejia (619) 553-6139
 ricardo.santoyomejia@navy.mil
 Anirudha Siripuram (619) 553-8749
 anirudha.siripuram@navy.mil
 Ron Thompson (619) 553-0457
 ron.thompson@navy.mil
 Electromagnetics Technology Branch, Code 5542
 Branch Head: Matt Osburn (619) 553-5941
 matthew.osburn@navy.mil
 Dr. Rich Adams (619) 553-4313
 rich.adams@navy.mil
 Mr. Jim Birkett (619) 553-3586
 jim.birkett@navy.mil
 Mr. Jose L. Chavez (619) 553-5075
 jose.chavez@navy.mil
 Dr. Will Cronyn (619) 553-5084
 will.cronyn@navy.mil
 Mr. Chris Dilay (619) 553-3794
 chris.dilay@navy.mil
 Mr. Vincent V. Dinh (619) 553-7255
 vincent.v.dinh@navy.mil
 Ms. Silvia Goodman, Secretary (619) 226-5953
 silvia.goodman@navy.mil
 Mr. David Hilton (619) 553-2666
 david.r.hilton@navy.mil
 Mr. Carl P. Kugel (619) 553-3066
 carl.kugel@navy.mil

Ms. Wendy Massey(619) 553-9711
 wendy.massey@navy.mil
 Mr. Daniel Meeks (619) 553-6753
 daniel.meeks@navy.mil
 Dr. John D. Rockway(619) 553-5438
 john.rockway@navy.mil
 Mr. Alberto Rodriguez (619) 553-5697
 alberto.rodriguez2@navy.mil
 Advanced Electromagnetic Technology Branch, Code 5546
 Branch Hd.: Jodi McGee (619) 553-3778
 jodi.mcgee@navy.mil
 Diana Arceo (619) 553-6344
 diana.arceo@navy.mil
 Lam T. Bui (619) 553-6038
 lam.bui@navy.mil
 Jennifer Edwards (619) 553-5428
 jennifer.edwards@navy.mil
 Daniel R. Gaytan (619) 553-7461
 daniel.gaytan@navy.mil
 John L. Hunter (619) 553-5086
 john.hunter@navy.mil
 Lillie Jackson, Secretary (619) 553-5076
 lillie.jackson@navy.mil
 Dr. Burt Markham (619) 553-6082
 burt.markham@navy.mil
 Mr. Marcus Maurer (619) 553-3797
 marcus.maurer@navy.mil
 Mr. Aldo Monges (619) 553-6129
 aldo.monges@navy.mil
 Mr. Filemon Peralta (619) 553-3043
 filemon.peralta@navy.mil
 Mr. Hoa Phan (619) 553-0148
 hoa.phan@navy.mil
 Mr. Randall Reeves (619) 553-1032
 randall.reeves@navy.mil
 Mr. Anthony Ton (619) 553-5428
 anthony.ton@navy.mil
 Mr. Daryl W. Von Mueller (619) 553-6527
 daryl.vonmueller@navy.mil
 Mr. Benton Wong (619) 553-3043
 benton.wong@navy.mil

Chief of Naval Operations

Code NC-1, PT-5451, N6F13

2000-Navy Pentagon, Washington, DC 20350-2000
 Fax: (703) 601-1323
 Spectrum Electromagnetic Environmental Effects (E3) & EMP Policy & Programs
 Head: Mr. Dave D. Harris (703) 601-3968
 dave.harris@navy.mil

Naval Ordnance Safety and Security Activity (NOSSA)

NAVORDSAFSEC ACT INDIAN HEAD

Electrical Explosives Safety

Code N84

Farragut Hall, Bldg. D323, 23 Strauss Ave.
 Indian Head, MD 20640-5035, Fax: (301) 744-6088
 Weapons Assessment (N8)
 Director: Charles Denham (301) 744-4447
 charles.denham@navy.mil

Naval Research Laboratory

Code 5348

4555 Overlook Ave., S.W., Washington, D.C. 20375-5320
 Tel.: (202) 404-7726, Mr. Larry Cohen
 Lawrence.Cohen@nrl.navy.mil

Naval SeaSystems Command (NAVSEA)

Force Electromagnetic Environmental Effects (E3)

and Spectrum Management Warfare Systems

Engineering Directorate (SEA 06)

1333 Isaac Hull Ave., S.E., Stop 5011, Washington Navy
 Yard, DC 20376-5011, Fax: (202) 781-4568
 Force E3 and Spectrum Management Branch

Branch Head: Mr. J. Don Pierce (202) 781-4214
james.d.pierce@navy.mil

Naval Surface Warfare Center, Crane Division (NSWC Crane) Code GXS

300 Highway 361, Bldg. 3287E, Crane, IN 47522
Fax: (812) 854-3589
Mr. Larry McKibben (812) 854-5107
Lawrence.McKibben@navy.mil

Naval Surface Warfare Center Dahlgren Division

5493 Marple Road, Suite 156, Dahlgren, VA 22448-5153
Electromagnetic Effects Division, Code Q50
Div. Hd: Mr. Marshall Baugher (540) 653-3416
marshall.baugher@navy.mil

Electromagnetic Effects Division
Chief Engineer: Mr. Jason Bardine (540) 653-7450
Jason.bardine@navy.mil

NAVSEA E3 Technical Warrant Holder:
Mr. Kurt Mikoleit (540) 653-3425
Kurt.mikoleit@navy.mil

E3 Spectrum Supportability Branch, Code Q51
Branch Head: Mrs. Amy Sunshine Smith-Carroll (540) 653-1694
amy.smith-carroll@navy.mil

E3 Spectrum Supportability Branch, Code Q51
Operations and Spectrum Support Group Lead: Mr. Mark Flenner (540) 653-7892
Mark.I.fleener@navy.mil

E3 Spectrum Supportability Branch, Code Q51
Spectrum Engineering Group Lead: Ms. Margaret Neel (540) 653-8021
Margaret.neel@navy.mil

E3 Spectrum Supportability Branch, Code Q51
Electromagnetic Pulse Group Lead: Mr. Blaise Corbett (540) 653-2104
Blaise.corbett@navy.mil

E3 Assessment & Evaluation Branch (Q52)
Branch Head: Mr. William T. Lenzi (540) 653-3444
william.lenzi@navy.mil

E3 Assessment & Evaluation Branch (Q52)
EMC/EMV Evaluation Group Lead: Mr. James McGinniss (540) 653-0489
james.mcginness@navy.mil

E3 Assessment & Evaluation Branch (Q52)
RADHAZ Program Manager: Mr. Richard Magrogan (540) 653-3445
richard.magrogan@navy.mil

E3 Assessment & Evaluation Branch (Q52)
Weapons System E3 Group Lead: Mr. Michael Miller . (540) 653-3460
michael.d.miller4@navy.mil

E3 Assessment & Evaluation Branch (Q52)
HERO Systems Certification Group Lead: Mr. Andrew Rash (540) 653-1368
andrew.a.rash@navy.mil

E3 Assessment & Evaluation Branch (Q52)
EMI/461 Lab Group Lead: Mr. Carl Hager (540) 653-9501
carl.hager@navy.mil

E3 Assessment & Evaluation Branch (Q52)
Test Operations Group Lead: Mr. Matthew Curtis (540) 653-3439
matthew.a.curtis@navy.mil

E3 Assessment & Evaluation Branch (Q52)
Science & Technology Applications Group Lead: Mr. Michael Slocum (540) 653-2212
michael.slocum@navy.mil

E3 Assessment & Evaluation Branch (Q52)
RADHAZ Environment Characterization Group Lead: Ms. Tamera Hay (540) 653-1419
tamera.hay@navy.mil

E3 Assessment & Evaluation Branch (Q52)

Surface Maritime Sensors Group Lead: Mr. Michael Workman (540) 653-4646
michael.i.workman@navy.mil

E3 Platform Integration Branch (Q53)
Branch Head: Mr. Kenneth D. Larsen (540) 653-3476
kenneth.d.larsen@navy.mil

E3 Platform Integration Branch (Q53)
Senior Scientist: Dr. Greg Balchin (540) 653-6037
gregory.a.balchin@navy.mil

E3 Platform Integration Branch (Q53)
MAAC Group Lead: Mr. Greg Brobjorg (540) 653-7075
greg.brobjorg@navy.mil

E3 Platform Integration Branch (Q53)
Combatant Group Lead: Mr. Reza Biazaran (540) 284-0595
reza.biazaran1@navy.mil

E3 Platform Integration Branch (Q53)
CVN Group Lead: Mr. Tim Baseler (540) 653-0741
timothy.baseler@navy.mil

E3 Platform Integration Branch (Q53)
Computational Electromagnetics Group Lead: Mr. Bryan Wagaman (540) 653-3430
bryan.wagaman@navy.mil

E3 Systems Interoperability Branch, Code Q54
Branch Head: Mr. Rich Link (540) 653-8907
rich.link@navy.mil

E3 Systems Interoperability Branch, Code Q54
Shipboard EMC Improvement Program Lead: Mr. Mark Hamer (540) 284-0711
mark.hamer@navy.mil

E3 Systems Interoperability Branch, Code Q54
Force E3 Interoperability Group Lead: Mr. John "Bart" Barbee (540) 653-3483
john.s.barbee@navy.mil

E3 Systems Interoperability Branch, Code Q54
Communication Systems E3 Interoperability Group Lead: Mr. Cris Lake (540) 653-5087
cris.lake@navy.mil

E3 Systems Interoperability Branch, Code Q54
Radar Systems E3 Interoperability Group Lead: Mr. Al Pitts (540) 653-6268
albert.pitts@navy.mil

E3 Systems Interoperability Branch, Code Q54
Electronic Warfare Systems E3 Interoperability Group Lead: Mr. Brad Conner (540) 653-0610
bradley.conner@navy.mil

Naval Undersea Warfare Center (NUWC)

1176 Howell St.
Newport, RI 02841-1708, Fax: (401) 832-7423
Submarine Electromagnetic Environmental Effects (E3) Branch, Code 3431

Branch Head: Mr. Craig F. Derewiany (401) 832-5542
craig.derewiany@navy.mil
Mr. Scott Albert (401) 832-4122
scott.albert@navy.mil

Mr. Jon Bond (401) 832-6480
jon.bond@navy.mil
Mr. Michael J. Carpenter (401) 832-5540
michael.j.carpenter@navy.mil

Mr. Douglas L. DeAngelis (401) 832-5872
douglas.deangelis@navy.mil
Mr. Jamie A. Donais (401) 832-3603
jamie.donais@navy.mil

Mr. Anthony Francis (401) 832-5493
anthony.francis1@navy.mil
Mr. Edward R. Javor (401) 832-5546
edward.javor@navy.mil

Mr. Alan T. McHale (401) 832-5635
alan.mchale@navy.mil
Mr. Michael P. Martin (401) 832-5630
michael.p.martin@navy.mil

Mr. Paul D. Opperman (401) 832-4092
paul.opperman@navy.mil
Mr. Fredric A. Stawarz (401) 832-5550
fredric.stawarz@navy.mil

Mr. John L. Thibeault (401) 832-5551
john.thibeault@navy.mil
Mr. Richard L. Thibeault (401) 832-5552
richard.thibeault@navy.mil

Mr. Oleg Volchansky (401) 832-5399
oleg.volchansky@navy.mil
Mr. Oscar R. Zelaya (401) 832-5597
oscar.zelaya@navy.mil

EMC Laboratory (401) 832-5554

OPNAV N2N6F1221

Spectrum Management and Electromagnetic Environmental Effects Office Net-Centric Capabilities/Strategic and Tactical Communications Branch Information Dominance Directorate
2511 Jefferson Davis Highway, Arlington, VA 22244-0001, Tel: (703) 601-1414; Fax: (703) 601-1323
Director: Mr. D. Mark Johnson (703) 601-1414
david.m.johnson4@navy.mil

OTHER UNITED STATES AGENCIES

Dept. of Health & Human Services Food and Drug Administration Center for Devices and Radiological Health

12725 Twinbrook Pkwy. (HFZ 133), Rockville, MD 20852
Tel.: (301) 827-4944
Electrophysics Branch, Div. Physical Sciences
Mr. Howard I. Bassen, Chief
Mr. Paul S. Ruggera
Mr. Donald Witters

U.S. Environmental Protection Agency (EPA) Office of Radiation and Indoor Air (ORIA) Radiation Protection Division (6608J)

1200 Pennsylvania Ave., N.W., Washington, DC 20460
Fax: (202) 343-3204
Director: Mr. Jonathan Edwards (202) 343-9437
edwards.jonathan@epa.gov
Mr. Norbert Hankin (202) 343-9235
hankin.norbert@epa.gov

HQ, Federal Aviation Administration ATC Spectrum Engineering Services, AJW-6

800 Independence Avenue, S.W.
Washington, DC 20591, Dir.: VACANT
Spectrum Assignment & Engineering Office, AJW-932
Manager: Mr. Jerrold B. Sanders (202) 267-9720
Jerrold.Sanders@faa.gov
Spectrum Planning & International Office, AJW-933
Manager: Mr. Robert A. Frazier (202) 267-9722
Robert.Frazier@faa.gov

Federal Aviation Administration FAA Aviation Safety (AMN-110N)

1601 Lind Ave. S.W., Renton, WA 98057
Fax: (425) 917-6590
Chief Scientific & Technical Advisor - Aircraft EMC:
Mr. David Walen (425) 917-6586
dave.walen@faa.gov

Federal Communications Commission

445 12th Street, SW, Washington, DC 20554, Office of Engineering & Technology, Tel.: (202) 418-2470
Chief: Julius P. Knapp
Deputy Chiefs: Mr. Ira Keltz, Ronald Repasi, Alan Stillwell; Associate Chief: Bruce Romano
Policy & Rules Division
Tel.: (202) 418-2472
Chief: Geraldine Matise
Deputy Chief: Mark Settle
Spectrum Policy Branch
Chief: Mr. Jamison Prime

Technical Rules Branch
 Chief: Ms. Karen Ansari
 Spectrum Coordination Branch
 Chief: VACANT
 Electromagnetic Compatibility Division
 Tel: (202) 418-2475
 Chief: Walter Johnston
 Technical Analysis Branch
 Chief: Mr. Robert Weller
 Experimental Licensing Branch
 Chief: Mr. James Burtile

Federal Communications Commission Laboratory

7435 Oakland Mills Rd., Columbia, MD 21046

FCC Laboratory Division

Dr. Rashmi Doshi, Chief (301) 362-3011
 Mr. Jim Szeliga (301) 362-3051
 Mrs. Pat Wright (301) 362-3001

Equipment Authorization Branch

Mr. Joe Dichosco, Chief (301) 362-3024
 Ms. Evelyn Cherry (301) 362-3022
 Mr. Steve Dayhoff (301) 362-3027
 Mr. Tim Harrington (301) 362-3039
 Mr. Andrew Leimer (301) 362-3049
 Mr. Stanley Lyles (301) 362-3047
 Ms. Diane Poole (301) 362-3034

Audits and Compliance Branch

Mr. Raymond Laforge, Chief (301) 362-3041
 Mr. David Galosky (301) 362-3290
 Ms. Katie Hawkins (301) 362-3030
 Ms. Phyllis Parrish (301) 362-3045
 Mr. Martin Perrine (301) 362-3025
 Mr. Richard Tseng (301) 362-3054
 Mr. Samuel Uganzenwoko (301) 362-3033

Technical Research Branch

Mr. William Hurst, Chief (301) 362-3031
 Mr. Kwok Chan (301) 362-3055
 Mr. James Drasher (301) 362-3047
 Mr. Steve Jones (301) 362-3056
 Mr. Steve Martin (301) 362-3052
 Mr. Tom Phillips (301) 362-3044
 Mr. George Tannahill (301) 362-3026

Customer Service Branch

Mrs. Sandy Haase, Chief (301) 362-3013
 Ms. Bessie Bordenave (301) 362-3046
 Ms. Linda Elliott (301) 362-3032
 Mr. Tim Jamerson (301) 362-3014
 Mr. Ken Reitzel (301) 362-3015
 Ms. Bette Taube (301) 362-3028
 Mrs. Joycelyn Walls (301) 362-3017

Goddard Space Flight Center

Greenbelt, MD 20771

Code 565 Electrical Systems Branch

Mr. Steven Graham, EMC Engr. (301) 286-3248
 Steven.M.Graham.1@nasa.gov

Code 549.0, Electromagnetic Systems Engineering

Mr. Todd Bonalsky, PhD, lead engineer
 (301) 286-1008

Todd.M.Bonalsky@nasa.gov

National Aeronautics and Space Administration

Kennedy Space Center

Kennedy Space Center, FL 32899

EMC Engineers

Team Lead: Ms. Dawn Trout (VA-F3), ... (321) 867-5366
 dawn.h.trout@nasa.gov
 Mr. Ron Brewer (Analex) (321) 867-5329
 ronald.w.brewer-1@nasa.gov
 Mr. Kevin Clinton (VA-F3) (321) 867-5314
 kevin.j.clinton@nasa.gov
 Mr. Tung Doan (321) 867-5330
 tung.m.doan@nasa.gov
 Mr. Paul Edwards (321) 867-8927

paul.edwards@nasa.gov
 Ms. Catherine C. Lewis 216-433-3806
 Catherine.c.lewis@nasa.gov
 Mr. Noel Sargent (Analex) (216) 433-3395
 noel.b.sargent@nasa.gov
 Mr. James Stanley (321) 867-1991
 james.e.stanley@nasa.gov
 Mr. Jarek Tracz (321) 867-2780
 jarek.a.tracz@nasa.gov
 EMC Test Engineer Manager: Mr. Jack Cowras (VB-E1)
 (321) 867-2914
 john.cowras-1@nasa.gov

National Aeronautics and Space Administration

Langley Research Center

5 North Dryden St., Bldg. 1202, Hampton, VA 23665

Fax: (757) 864-9884

EMC Test Facility (MS 130)

Ms. Courtney Rollins (757) 864-7814
 c.h.rollins@larc.nasa.gov
 HIRF Laboratory (MS 130)
 Mr. Jay J. Ely (757) 864-1868
 j.j.ely@nasa.gov
 Mr. Truong X. Nguyen (757) 864-7528
 t.x.nguyen@larc.nasa.gov
 EMI/EMC Analysis and Troubleshooting (MS 488)
 Dr. Arthur T. Bradley (757) 864-7343
 arthur.t.bradley@nasa.gov

National Aeronautics and Space Administration

John H. Glenn Research Center

21000 Brookpark Road, Cleveland, OH 44135

EMC Engineer

Mr. Tesfahunei T. Teclé (216) 433-6620
 tesfahunei.t.tecle@grc.nasa.gov

National Aeronautics and Space Administration

Lyndon B. Johnson Space Center

2101 NASA Rd., Houston, TX 77058-3696

Avionics Systems Test Branch (EV4)

Branch Chf.: Ms. Linda Bromley (281) 483-0129
 Analysis Grp. Ldr.: Ms. C. Sham (281) 483-0124
 EMC Grp. Ldr.: Mr. Robert Scully (281) 483-1499
 robert.c.scully@nasa.gov

EMC Test Laboratory

Facility Mgr: Mr. Rod Robinson (281) 483-1465
 Electronic Systems Test Laboratory
 Facility Mgr: Mr. Ned Robinson (281) 483-0130

National Aeronautics and Space Administration

George C. Marshall Space Flight Center

Marshall Space Flight Center, AL 35812

Spectrum Manager: Terry Luttrell (256) 544-0130
 Terry.Luttrell@nasa.gov

EMC Engineers (M/S ES42/4708)

Division Chief: Mr. Tony Clark (256) 544-2394
 Tony.Clark@nasa.gov
 Branch Chief: Mr. Jeff Wesley (256) 544-3393
 Jeff.Wesley@nasa.gov
 Team Lead: Mr. Mark Krome (256) 544-5635
 Mark.Krome@nasa.gov
 Mr. Michael Crane (ERC) (256) 544-7259
 Michael.G.Crane@nasa.gov
 Mr. Tim Dew (ERC) (256) 544-3718
 Timothy.M.Dew@nasa.gov
 Mr. Ross Evans (Dynerics) (256) 961-2305
 Ross.W.Evans@nasa.gov
 Ms. Tammy Flowers (256) 961-0508
 Tammy.D.Flowers@nasa.gov
 Mr. Truman Glasscock (Triumph) (256) 544-5318
 Truman.G.Glasscock@nasa.gov
 Mr. Kenneth Gonzalez (Qualis) (256) 544-1658

Kenneth.P.Gonzalez@nasa.gov
 Mr. Steve R Jones (256) 544-4373
 Steve.Jones@nasa.gov
 Mr. Steve Linthicum (Dynerics) (256) 544-5312
 Steven.E.Linthicum@nasa.gov
 Mr. Jonathan Mack (256) 544-3599
 Jonathan.D.Mack@nasa.gov
 Mr. Matthew McCollum (256) 544-2351
 Matt.Mccollum@nasa.gov
 Mr. Matthew McGrath (Dynerics) (256) 544-3051
 Matthew.M.McGrath@nasa.gov
 Mr. Tom Perry (Jacobs) (256) 544-0744
 Thomas.A.Perry@nasa.gov
 Mr. Glenn Shelby (256) 544-0694
 Glenn.Shelby@nasa.gov
 EMI Test Facility (256) 544-8121

National Institute of Standards and Technology

Electromagnetics Division, 687, Boulder, CO 80305

Div. Chief: Dr. Michael H. Kelley (303) 497-4736
 michael.kelley@boulder.nist.gov

Secretary: Ms. Mary Filla (303) 497-3132
 mary.filla@boulder.nist.gov

RF Fields Group 687.02

Group Leader: Dr. Perry F. Wilson (303) 497-3406
 pfw@boulder.nist.gov

Secretary: Mr. Gian Aparicio (303) 497-3321
 aparicio@boulder.nist.gov

Antenna Parameters (687.02 Project)

Mr. Jeffrey Guerrieri (303) 497-3863
 guerrieri@boulder.nist.gov

Wireless Systems (687.02 Project)

Dr. Kate Remley (303) 497-3652
 kate.remley@boulder.nist.gov

Field Parameters and EMC Applications (687.02 Project)

Galen Koepke (303) 497-5766
 koepke@boulder.nist.gov

Quantum Measurement Division, 684

Gaithersburg, MD 20899

Div. Chief: Dr. Carl Williams (301) 975-3531
 carl.williams@nist.gov

National Telecommunications and Information Administration (NTIA)

U.S. Department of Commerce

1401 Constitution Ave., N.W., Washington, DC 20230

(202) 482-1850

Emergency Planning Subcommittee Chairman

Chief: Mr. Stephen R. Veader (202) 482-4417
 sveader@ntia.doc.gov

Spectrum Planning Subcommittee Chairman

Chief: Mr. Stephen Butcher (202) 482-4163
 sbutcher@ntia.doc.gov

Institute for Telecommunications Sciences (ITS)

325 Broadway, Boulder, CO 80305-3328

Exec. Officer: Mr. Brian Lane (303) 497-3484
 blane@its.bldrdoc.gov

Director: Mr. Al Vincent (303) 497-3500

avincen@its.bldrdoc.gov

Spectrum & Propagation Measurements Division

Mr. Eric D. Nelson (303) 497-7410
 enelson@its.bldrdoc.gov

Telecommunications & Information Technology Planning Division

Mr. Jeffrey R. Bratcher (303) 497-5132
 jbratcher@its.bldrdoc.gov

Telecommunications Engineering, Analysis & Modeling Division

Ms. Patricia Raush (303) 497-3568
 praush@its.bldrdoc.gov

Telecommunications Theory Division

Mr. Frank Sanders (303) 497-7600
 fsanders@its.bldrdoc.gov

PRODUCTS & SERVICES INDEX

INTERFERENCE TECHNOLOGY'S 2012 EMC Products & Services Index contains approximately 250 different categories to help you find the equipment, components, and services you need. Locate additional product information by consulting the Advertiser Index on page 168. Full details of all the suppliers listed within each category can be found in the Company Directory, starting on page 151. For individual Products & Services Indexes broken out by category, see the box at the bottom of this page.

ABSORBER CLAMPS

DNB Engineering, Inc.
ETS-Lindgren
Fischer Custom Communications

ABSORPTIVE FILTERS

Dontech, Inc.
Instruments for Industry (IFI)
Intermark (USA) Inc.

ACTIVE FILTERS

LCR Electronics, Inc.
Schaffner EMC, Inc.

AMPLIFIERS

Advanced Test Equipment Rentals
AE Techron, Inc.
Amber Technologies
Applied Systems Engineering, Inc.
AR Receiver Systems
AR RF/Microwave Instrumentation
CAP Wireless
Comtech PST Corp.
CPI (Communications & Power Industries)
dB Control
Instruments for Industry (IFI)
MCL, Inc., A MITEQ Company
MILMEGA Ltd.
Noise Laboratory Co., Ltd.
NP Technologies, Inc.
Ophir RF
Pasternack Enterprises
Power Products International Ltd.
Quarterwave Corporation
Silicon Labs
Teseq

ANECHOIC CHAMBER CALIBRATION TO IEC 80-3

ETS-Lindgren
Panashield

ANECHOIC CHAMBER TESTING

D.A.R.E!! Instruments
DNB Engineering, Inc.
Electronics Test Centre (Kanata)
ETS-Lindgren
National Technical Systems
Radiometrics Midwest Corp.
Retlif Testing Laboratories
TUV SUD America Inc.

ANECHOIC CHAMBERS

Albatross Projects GmbH
ETS-Lindgren
Videon Central Inc.

ANECHOIC CHAMBERS – FIRE PROTECTION

ETS-Lindgren

ANECHOIC MATERIALS

ETS-Lindgren
Fair-Rite Products Corp.

ANTENNA FILTERS

Captor Corp.
Fotofab
Spectrum Advanced Specialty Products

ANTENNA MASTS

ETS-Lindgren

ANTENNAS

A.H. Systems, Inc.
Advanced Test Equipment Rentals
Applied Electromagnetic Technology LLC
AR RF/Microwave Instrumentation
ARA Technologies
Beehive Electronics
Com-Power Corp.
Dynamic Sciences International, Inc.
Electro-Metrics Corp.
ETS-Lindgren
Fotofab
Instruments for Industry (IFI)
Laird Technologies
Liberty Labs, Inc.
Lubrizol Conductive Polymers
Noise Laboratory Co., Ltd.
Q-par Angus Ltd.
Spectrum Advanced Specialty Products
Sunol Sciences Corp.
TDK Corp.
TDK RF Solutions
Teseq

ANTISTATIC COATINGS

Dontech, Inc.
Lamart Corp.
Swift Textile Metalizing LLC

ANTISTATIC MATERIALS

ACL Inc.
Swift Textile Metalizing LLC

ARCHITECTURAL SHIELDING PRODUCTS

Alco Technologies, Inc.
Kemtron Ltd.

AUDIO BAND POWER AMPLIFIERS

AE Techron, Inc.

AUTOMOTIVE TESTING

D.A.R.E!! Instruments
D.L.S. Electronic Systems, Inc.
Elite Electronic Engineering Co.
National Technical Systems
Radiometrics Midwest Corp.
Teseq

BACKSHELLS, SHIELDED ASSEMBLIES, TERMINATIONS

Federal-Mogul Corporation
Systems Protection
Kensington Electronics Inc.
Northern Technologies Corp.

BELLCORE TESTING (SEE TELCORDIA)

D.L.S. Electronic Systems, Inc.
National Technical Systems
TUV SUD America Inc.

BICONICAL ANTENNAS

A.H. Systems, Inc.
ETS-Lindgren
Instruments for Industry (IFI)
Liberty Labs, Inc.
Noise Laboratory Co., Ltd.
Teseq

BIDIRECTIONAL COUPLERS

Instruments for Industry (IFI)

BOARD LEVEL SHIELDS

3Gmetalworx World
W. L. Gore & Associates, Inc.

Kensington Electronics Inc.
Mech-Tronics
Photofabrication Engineering Inc.
Precision Photo-Fab, Inc.
Schlegel Electronic Materials
Tech-Etch, Inc.
United Western Enterprises, Inc
Kemtron Ltd.

BOOKS

Henry Ott Consultants
ITEM Media
Kimmel Gerke Associates, Ltd.
Montrose Compliance Service

BRAID

Alco Technologies, Inc.
Calmont Wire & Cable, Inc.
Federal-Mogul Corporation
Systems Protection
Syscom Advanced Materials

BROADBAND EMI DETECTORS

Advanced Test Equipment Rentals
Agilent Technologies, Inc.
ETS-Lindgren

CABINETS & HARDWARE

FIBOX Enclosures
Fotofab

CABLES & CONNECTORS

AEF Solutions
Alco Technologies, Inc.
Amphenol Industrial Operations
Brim Electronics, Inc.
Calbrooke Marketing Inc.
Captor Corp.
CONEC Corp. - USA
Electri-Flex Company
ETS-Lindgren

PRODUCTS & SERVICES INDEXES BY CATEGORY

Test Instrumentation	10
Testing	24
Amplifiers / Antennas	46
Filters / Ferrites	56
Cables / Connectors	80
Shielding	82
Surge & Transients	94
Conductive Materials	94

Federal-Mogul Corporation
Systems Protection
Fischer Connectors Inc.
Fotofab
Harwin
Hi-Tech Controls
Hi-Voltage & EMI Corp.
ITT Interconnect Solutions
Ja-bar Silicone Corporation
Lutze Inc.
PennEngineering
Positronic Industries
Potters Industries, Inc.
PSC Electronics
Qualtek Electronics Corp.
RIA CONNECT
Schaffner EMC, Inc.
Schurter Inc.
Sealcon
Spectrum Advanced Specialty
Products
Swift Textile Metalizing LLC
Teledyne Reynolds
Wilcoxon Research
Wurth Electronics Midcom Inc.

CALIBRATION SERVICES

A.H. Systems, Inc.
Austest Laboratories
D.A.R.E!! Calibrations
ETS-Lindgren
Fischer Custom Communications
Instruments for Industry (IFI)
LTI Metrology
National Technical Systems
Pearson Electronics, Inc.
Teseq
TUV SUD America Inc.

CALIBRATION TESTING

D.A.R.E!! Calibrations
Liberty Labs, Inc.

CERTIFICATION SERVICES

Braco Compliance Ltd.
D.L.S. Electronic Systems, Inc.
DNB Engineering, Inc.
Electronics Test Centre (Kanata)
Elite Electronic Engineering Co.
ITEM Media
MET Laboratories, Inc.
National Technical Systems
Radiometrics Midwest Corp.
TUV SUD America Inc.

CHAMBERS REVERB

ETS-Lindgren

COAXIAL FILTER CONNECTORS

Captor Corp.
EMC Eupen, A Div. of I2R Corp.
Kensington Electronics Inc.
Soshin Electronics Europe GmbH
Spectrum Advanced Specialty
Products

**COMPETENT/CERTIFIED
ACCREDITING BODIES TESTING**

D.A.R.E!! Instruments
D.L.S. Electronic Systems, Inc.
Elite Electronic Engineering Co.
National Technical Systems

**COMPUTER-AIDED ANALYSIS
SERVICES**

Apache Design Solutions
CST of America, Inc.
Electronics Test Centre (Kanata)
ETS-Lindgren
National Technical Systems
TUV SUD America Inc.
Visron Design, Inc.

**CONDUCTIVE ADHESIVES,
CAULKS, EPOXIES &
ELASTOMERS**

Alco Technologies, Inc.
ARC Technologies, Inc.
Creative Materials, Inc.
Dontech, Inc.
EEMCCOIMEX
Ja-bar Silicone Corporation
Kemtron Ltd.
Metal Textiles Corp.
P&P Technology Ltd.
Silicone Solutions
Sunkyoung S.T.
VTI Vacuum Technologies, Inc.
Seal Science
Tech-Etch, Inc.

CONDUCTIVE CLOTH

Alco Technologies, Inc.
ARC Technologies, Inc.
Dontech, Inc.
Eonux Corporation
Federal-Mogul Corporation
Systems Protection
Intermark (USA) Inc.
Ja-bar Silicone Corporation
Jinan EMI Shielding Technology
Co., Ltd.
Kemtron Ltd.
Swift Textile Metalizing LLC

CONDUCTIVE COATINGS

Alco Technologies, Inc.
ALX Technical
Conductive Compounds Inc.
Dontech, Inc.
Ja-bar Silicone Corporation
Master Bond
Plastic-Metals Technologies,
Inc.
Swift Textile Metalizing LLC
VTI Vacuum Technologies, Inc.

CONDUCTIVE CONTAINERS

MuShield Company, Inc.
Swift Textile Metalizing LLC
VTI Vacuum Technologies, Inc.

CONDUCTIVE LAMINATES

Dontech, Inc.
Ja-bar Silicone Corporation
Kemtron Ltd.
Swift Textile Metalizing LLC

CONDUCTIVE MATERIALS

3M Electronics Markets
Materials Division
Adhesives Research, Inc.
Alchemetal
Alco Technologies, Inc.
Antistatic Industries of Delaware
ARC Technologies, Inc.
Caprock Mfg.
Cool Polymers, Inc.
Creative Materials, Inc.
Desco Industries Inc.
Device Technologies, Inc.
Dontech, Inc.
EEMCCOIMEX
Eonux Corporation
Federal-Mogul Corporation
Systems Protection
Intermark (USA) Inc.
Ja-bar Silicone Corporation
Kemtron Ltd.
LGS Technologies
M&C Specialties
Marktek Inc.
Master Bond
MTI - Microsorb Technologies,
Inc.
Mueller Corp.
Oak-Mitsui Technologies
P&P Technology Ltd.
Premix Oy
Progressive Fillers International
Sealing Devices Inc.
Sulzer Metco (Canada) Inc.
Swift Textile Metalizing LLC
Tech-Etch, Inc.
THEMIX Plastics, Inc.
Venture Tape Corp.
VTI Vacuum Technologies, Inc.

CONDUCTIVE PAINT

Alco Technologies, Inc.
Dontech, Inc.
Swift Textile Metalizing LLC

CONDUCTIVE PARTICLES

Ja-bar Silicone Corporation

CONDUCTIVE PLASTICS

CAPLINQ Corp.
Cool Polymers, Inc.
Dexmet Corporation

Dontech, Inc.
Premix Oy
VTI Vacuum Technologies, Inc.

CONDUCTIVE PLATING

Dontech, Inc.
Ja-bar Silicone Corporation
Kemtron Ltd.
Swift Textile Metalizing LLC
VTI Vacuum Technologies, Inc.

CONDUCTIVE TAPES

Alco Technologies, Inc.
Bystat International Inc.
Dontech, Inc.
Intermark (USA) Inc.
ITW/Pressure Sensitive
Adhesives & Components
Ja-bar Silicone Corporation
Kemtron Ltd.
M&C Specialties
P&P Technology Ltd.
Swift Textile Metalizing LLC

**CONDUIT, ELECTRICAL,
SHIELDED, MAGNETIC & RF**

Federal-Mogul Corporation
Systems Protection
Ja-bar Silicone Corporation
Kemtron Ltd.
VitaTech Electromagnetics

CONSULTANTS

Captor Corp.
D.A.R.E!! Instruments
D.L.S. Electronic Systems, Inc.
DNB Engineering, Inc.
Don HEIRMAN Consultants
Elite Electronic Engineering Co.
EM Software & Systems
EMC Cons Dr. Rasek GmbH
EMC Management Concepts
EMCC Dr. Rasek
EMCMCC
EMITEMC
Equipment Reliability Institute
ERA Technology Ltd. Trading as
Cobham Technical Services
ETS-Lindgren
Henry Ott Consultants
Hoolihan EMC Consulting
ITEM Media
Kimmel Gerke Associates, Ltd.
Montrose Compliance Service,
Inc.
MOOSER Consulting GmbH
NewPath Research L.L.C.
Paladin EMC

Update, add or edit your company's information in the
EMC Buyers' Guide at www.interferencetechnology.com

Power & Controls Engineering Ltd.
Power Standards Lab (PSL)
Radiometrics Midwest Corp.
Retlif Testing Laboratories
TUV SUD America Inc.
Wyatt Technical Services LLC

COUPLING-DECOUPLING NETWORKS

Haefely EMC

CRT ELECTRO-OPTICAL SHIELDS

Dontech, Inc.
MµShield Company, Inc.

CURRENT PROBES

A.H. Systems, Inc.
ETS-Lindgren
Fischer Custom Communications
Pearson Electronics, Inc.

DESIGN SOFTWARE

AR RF/Microwave Instrumentation
AWR Corporation
CST of America, Inc.
EM Software & Systems
Moss Bay EDA
Sonnet Software, Inc.

DIE CUT SHIELDING MATERIAL

Apex Die & Gasket Inc.
Dontech, Inc.
W. L. Gore & Associates, Inc.
Identification Products Corp
Ja-bar Silicone Corporation
Kemtron Ltd.
Orion Industries Inc.
P&P Technology Ltd.
Spira Manufacturing Corp.
Tech-Etch, Inc.

DIRECT LIGHTNING TESTING

DNB Engineering, Inc.
Electronics Test Centre (Kanata)
National Technical Systems
TUV SUD America Inc.

DISCOIDAL CAPACITORS

Union Technology Corp.

E-FIELD ANTENNAS

A.H. Systems, Inc.
Advanced Test Equipment Rentals
AR RF/Microwave Instrumentation
ETS-Lindgren

Instruments for Industry (IFI)
Noise Laboratory Co., Ltd.

ELECTRIC FIELD PROBES

Agilent Technologies, Inc.

ELECTROSTATIC CHARGE / DECAY METERS

Amstat Industries, Inc.
TREK, INC.

ELECTROSTATIC DISCHARGE (ESD) GENERATORS

Advanced Test Equipment Rentals
EM Test USA
EMC Partner AG
Haefely EMC
Noise Laboratory Co., Ltd.

ELECTROSTATIC DISCHARGE (ESD) SIMULATORS

Advanced Test Equipment Rentals
CST of America, Inc.
EM Test USA
EMC Partner AG
Fischer Custom Communications
Haefely EMC
HV Technologies, Inc.
Liberty Labs, Inc.
National Technical Systems
Noise Laboratory Co., Ltd.

ELECTROSTATIC DISCHARGE (ESD) TESTING

D.L.S. Electronic Systems, Inc.
DNB Engineering, Inc.
Elite Electronic Engineering Co.
Radiometrics Midwest Corp.
Retlif Testing Laboratories
TUV SUD America Inc.

EMI GASKETS

ACS Industries, Inc.
Boyd Corporation
CGS Technologies
Connors Company
Fabritech, Inc.
GETELEC
W. L. Gore & Associates, Inc.
Insulfab
Intermark (USA) Inc.
Ja-bar Silicone Corporation
Kemtron Ltd.
P&P Technology Ltd.
Spira Manufacturing Corp.
Stockwell Elastomers, Inc.
Tech-Etch, Inc.

United Seal and Rubber Co., Inc.
VTI Vacuum Technologies, Inc.

EMI RECEIVERS

Agilent Technologies, Inc.
AR RF/Microwave Instrumentation
GAUSS Instruments
Inceleris

EMI TEST ANTENNAS

A.H. Systems, Inc.
Advanced Test Equipment Rentals
AR RF/Microwave Instrumentation
ETS-Lindgren
Fotofab
Instruments for Industry (IFI)
Laird Technologies
TDK RF Solutions

EMISSIONS TESTING

Captor Corp.
D.A.R.E!! Instruments
D.L.S. Electronic Systems, Inc.
DNB Engineering, Inc.
Don HEIRMAN Consultants
Electronics Test Centre (Kanata)
Elite Electronic Engineering Co.
maturo GmbH
Mitsubishi Digital Electronics America Inc.
Montrose Compliance Service, Inc.
National Technical Systems
Radiometrics Midwest Corp.
Retlif Testing Laboratories
TUV SUD America Inc.
V-Comm, LLC

EMP GENERATORS

EM Test USA
EMC Partner AG
Fischer Custom Communications
HV Technologies, Inc.

EMP SIMULATORS

Advanced Test Equipment Rentals
CST of America, Inc.
EM Test USA
EMC Partner AG
Fischer Custom Communications
HV Technologies, Inc.
Montena Technology sa
National Technical Systems

EMP, SGEMP SYSTEM ASSESSMENT

DNB Engineering, Inc.
Kimmel Gerke Associates, Ltd.
National Technical Systems

EMP/LIGHTNING EFFECTS TESTING

D.L.S. Electronic Systems, Inc.
DNB Engineering, Inc.
Electronics Test Centre (Kanata)
Elite Electronic Engineering Co.
National Technical Systems

Radiometrics Midwest Corp.
Retlif Testing Laboratories
Teseq
TUV SUD America Inc.

ENVIRONMENTAL TESTING

D.A.R.E!! Instruments
D.L.S. Electronic Systems, Inc.
Elite Electronic Engineering Co.
National Technical Systems
TUV SUD America Inc.

EUROPEAN CERTIFICATION TESTING

D.A.R.E!! Instruments
D.L.S. Electronic Systems, Inc.
DNB Engineering, Inc.
Electronics Test Centre (Kanata)
Elite Electronic Engineering Co.
EMC Testing Laboratories, Inc.
EU Compliance Services, Inc.
F-Squared Laboratories
GTN GmbH & Co. KG
INTERTest Systems, Inc.
ITL Israel
Montrose Compliance Service
National Technical Systems
Radiometrics Midwest Corp.
Retlif Testing Laboratories
TUV Rheinland Of North America
TUV SUD America Inc.

FACILITIES & SHIELDED ENCLOSURE SERVICES

AR Tech
Compac Development Corp.
DNB Engineering, Inc.
ETS-Lindgren
Rittal Corp.

FCC PART 15 & 18 TESTING

D.A.R.E!! Instruments
D.L.S. Electronic Systems, Inc.
DNB Engineering, Inc.
Don HEIRMAN Consultants
Electronics Test Centre (Kanata)
Elite Electronic Engineering Co.
Montrose Compliance Service
National Technical Systems
Radiometrics Midwest Corp.
Retlif Testing Laboratories
TUV SUD America Inc.

FCC PART 68 TEST EQUIPMENT

DNB Engineering, Inc.
EM Test USA
EMC Partner AG
HV Technologies, Inc.
Retlif Testing Laboratories

FCC PART 68 TESTING

D.L.S. Electronic Systems, Inc.
DNB Engineering, Inc.
Electronics Test Centre (Kanata)
Elite Electronic Engineering Co.
Haefely EMC
National Technical Systems

For more information on these and other EMI/EMC companies, visit the new and improved Interference Technology EMC Buyers' Guide at www.interferencetechnology.com

FEED-THROUGH FILTERS

Captor Corp.
EMI Filter Company
Instec Filters
Radius Power, Inc.
RF Immunity Ltd.
Schaffner EMC, Inc.
Spectrum Advanced Specialty Products
Syfer Technology Limited
TDK-EPC Corp.
Tri-Mag, Inc.

FERRITE BEADS & CORES

AEM, Inc.
Allied Components International
Cosmo Ferrites Limited
Fair-Rite Products Corp.
Ferronics, Inc.
Intermark (USA) Inc.
Kemtron Ltd.
Magnet Industry Ltd.
MEC Kitagawa
National Magnetics Group, Inc.
TDK-EPC Corp.
THORA Elektronik GmbH

FERRITE SUPPRESSION COMPONENTS

ARC Technologies, Inc.
Fair-Rite Products Corp.
Intermark (USA) Inc.
Kemtron Ltd.
Spectrum Advanced Specialty Products

FERRITES

Adams Magnetic Products Co.
AEM, Inc.
Allied Components International
ARC Technologies, Inc.
Dexter Magnetic Technologies
EMC Component Group, Inc.
Fair-Rite Products Corp.
Intermark (USA) Inc.
Kemtron Ltd.
Magnet Industry Ltd.
MEC Kitagawa
Spectrum Advanced Specialty Products
Taiyo Yuden (U.S.A.) Inc.

FIBER OPTIC CABLES

ETS-Lindgren

FIBER OPTIC SYSTEMS

Accurate Controls Ltd.
D.A.R.E!! Consultancy
Fischer Custom Communications
Michigan Scientific Corp.
Micronor Inc.

FIELD INTENSITY METERS

EMC Test Design
ETS-Lindgren
Instruments for Industry (IFI)
Narda Safety Test Solutions S.r.l.

Potomac Instruments Inc.
SRICO, Inc.

FILTER ARRAYS

Captor Corp.
Fotofab
Syfer Technology Limited
Spectrum Advanced Specialty Products

FILTER CAPACITORS

AVX Corporation
Beijing Tempest Electronics Technologies Co. Ltd.
Captor Corp.
EMI Filter Company
Fotofab
Instec Filters
LCR Electronics, Inc.
Radius Power, Inc.
Schaffner EMC, Inc.
Spectrum Advanced Specialty Products
Syfer Technology Limited
Synergistic Technology Group, Inc.
TDK-EPC Corp.
X2Y Attenuators LLC

FILTER CHOKES

Captor Corp.
Datatronics
Fair-Rite Products Corp.
LCR Electronics, Inc.
Radius Power, Inc.
Schaffner EMC, Inc.
Schurter Inc.

FILTER COILS

Captor Corp.
Communication Coil, Inc.
Curtis Industries / Filter Networks
Radius Power, Inc.
Schaffner EMC, Inc.
Schurter Inc.

FILTER CONNECTORS

AEF Solutions
Captor Corp.
Curtis Industries / Filter Networks
Glenair Inc.
Heilind Electronics
Kensington Electronics Inc.
Spectrum Advanced Specialty Products
Spectrum Control
Schurter Inc.

FILTER MODULES

Captor Corp.
Curtis Industries / Filter Networks
Elite EMC Ltd.
Instec Filters
Schaffner EMC, Inc.
Schurter Inc.

Spectrum Advanced Specialty Products

FILTER PIN CONNECTORS

Captor Corp.
Fischer Connectors Inc.
Kensington Electronics Inc.
Spectrum Advanced Specialty Products

FILTER PINS

EMI Filter Company
Instec Filters
Spectrum Advanced Specialty Products
Syfer Technology Limited

FILTER SEAL INSERTS

Kensington Electronics Inc.
Lamart Corp.

FILTERED POWER ENTRY MODULES

Americor Electronics, Ltd.
Captor Corp.
Curtis Industries / Filter Networks
Qualtek Electronics Corp.
Radius Power, Inc.
Schaffner EMC, Inc.
Schurter Inc.
Spectrum Advanced Specialty Products
Tri-Mag, Inc.

FILTERS

Advanced Monolithic Ceramics, Inc.
Aerodev Electronmagnetic Tech
Alco Technologies, Inc.
Amphenol Canada Corp.
API Delevan
Arcotronics, Inc.
Aries Electronics
AVX Corporation
Capcon International, Inc.
Captor Corp.
Cre8 Associates Ltd.
Curtis Industries / Filter Networks
E3 Displays
EESeal
Electrocube, Inc.
Elite EMC Ltd.
EMI Filter Company
EMI Solutions Inc.
EPCOS, Inc.
ETS-Lindgren
Fil-coil
Filter Concepts, Inc.
Filtronica, Inc.
Fotofab
Fuss-EMV
Genisco Filter Corp.
Gowanda Electronics
High & Low Corporation
Instruments for Industry (IFI)
Integrated Microwave Corp.

Intermark (USA) Inc.
Jiangsu WEMC Technology Co., Ltd.
Johanson Dielectrics, Inc.
LCR Electronics, Inc.
Mercury United Electronics Inc.
MPE Limited
Murata Electronics North America
Oxley Developments Company Ltd.
Pacific Aerospace & Electronics, Inc.
Panasonic Electronic Components
Quell Corporation
Radius Power, Inc.
RFI Corp.
Roxburgh EMC
Sabritec
Schaffner EMC, Inc.
Schurter Inc.
SiTime Corp.
Souriau PA&E
Spectrum Advanced Specialty Products
Spectrum Control
Suppression Devices
Syfer Technology Limited
Synergistic Technology Group, Inc.
Texas Spectrum Electronics
Tyco Electronics
V Technical Textiles, Inc.
View Thru Technologies, Inc.
Vishay Intertechnology, Inc.
VPT, Inc.

FINGERSTOCK

Ja-bar Silicone Corporation
Kemtron Ltd.
P&P Technology Ltd.
Tech-Etch, Inc.

GROUND RESISTANCE TESTERS

AEMC Instruments, Inc.

GROUNDING RODS

Intermark (USA) Inc.

GROUNDING SERVICES

Intermark (USA) Inc.

GROUNDING SYSTEMS

Intermark (USA) Inc.
Lightning Eliminators & Consultants, Inc.

GTEM CELLS

ETS-Lindgren
Fischer Custom Communications
Instruments for Industry (IFI)
Noise Laboratory Co., Ltd.

H-FIELD ANTENNAS

A.H. Systems, Inc.

AR RF/Microwave Instrumentation
ETS-Lindgren
Instruments for Industry (IFI)
Noise Laboratory Co., Ltd.

HARNESSES

Captor Corp.

HELMHOLTZ COILS

ETS-Lindgren
Fischer Custom Communications

HIGH VOLTAGE PULSE TRANSFORMERS

Pearson Electronics, Inc.

HONEYCOMB SHIELDING

ETS-Lindgren
Intermark (USA) Inc.
Ja-bar Silicone Corporation
Kemtron Ltd.
P&P Technology Ltd.
Spira Manufacturing Corp.
Tech-Etch, Inc.

HORN ANTENNAS

A.H. Systems, Inc.
Advanced Test Equipment Rentals
AR RF/Microwave Instrumentation
ETS-Lindgren
Instruments for Industry (IFI)
Liberty Labs, Inc.
Teseq

HYBRID ANTENNAS

ETS-Lindgren

IMMUNITY TESTING

A.H. Systems, Inc.
D.A.R.E!! Instruments
D.L.S. Electronic Systems, Inc.
DNB Engineering, Inc.
Electronics Test Centre (Kanata)
Elite Electronic Engineering Co.
LEDE-SIECIT
National Technical Systems
Radiometrics Midwest Corp.
Retlif Testing Laboratories
Teseq
TUV SUD America Inc.

IMPULSE GENERATORS

AR RF/Microwave Instrumentation
Compliance West, USA
EM Test USA
EMC Partner AG
Haefely EMC
HV Technologies, Inc.

Ion Physics Corp.
National Technical Systems

INDUCED CURRENT METERS & PROBES

AR RF/Microwave Instrumentation
EMC Partner AG
ETS-Lindgren

INDUCTORS

BI Technologies
Captor Corp.
Curtis Industries / Filter Networks
Frontier Electronics, Corp.
Gowanda Electronics
Kensington Electronics Inc.
LCR Electronics, Inc.
Micrometals, Inc.
Schaffner EMC, Inc.
Schurter Inc.

INSERTION LOSS TEST NETWORKS

Captor Corp.

INTERFERENCE GENERATORS

EMC Partner AG
HV Technologies, Inc.

IRON CORE POWDERED MAGNETIC MATERIALS

Fair-Rite Products Corp.

ISO 9000 TESTING

Electronics Test Centre (Kanata)
National Technical Systems
Swift Textile Metalizing LLC
TUV SUD America Inc.

ISOTROPIC FIELD SENSORS

D.A.R.E!! Consultancy
ETS-Lindgren
Instruments for Industry (IFI)

LIGHTNING GENERATORS

Advanced Test Equipment Rentals
Avalon Test Equipment Corp.
EM Test USA
EMC Partner AG
Fischer Custom Communications
Haefely EMC
HV Technologies, Inc.
Lightning Technologies, Inc.
Noise Laboratory Co., Ltd.

LIGHTNING SIMULATORS

Advanced Test Equipment Rentals

EM Test USA
EMC Partner AG
Fischer Custom Communications
Haefely EMC
HV Technologies, Inc.
Noise Laboratory Co., Ltd.

LIGHTNING STRIKE TESTING

D.L.S. Electronic Systems, Inc.
DNB Engineering, Inc.
Elite Electronic Engineering Co.
National Technical Systems
Pearson Electronics, Inc.
Radiometrics Midwest Corp.
Retlif Testing Laboratories
TUV SUD America Inc.

LISNS

ETS-Lindgren

LOG PERIODIC ANTENNAS

A.H. Systems, Inc.
Advanced Test Equipment Rentals
AR RF/Microwave Instrumentation
ETS-Lindgren
Instruments for Industry (IFI)
Liberty Labs, Inc.
Noise Laboratory Co., Ltd.

MAGNETIC FIELD METERS

Combinova AB
Ergonomics, Inc.
Fischer Custom Communications

MAGNETIC FIELD PROBES

Agilent Technologies, Inc.
AR RF/Microwave Instrumentation
ETS-Lindgren
Fischer Custom Communications
Langer EMV-Technik GmbH

MAGNETIC SHIELDING

VTI Vacuum Technologies, Inc.

MAGNETIC SHIELDING GASKETS

Kemtron Ltd.
Spira Manufacturing Corp.
VTI Vacuum Technologies, Inc.

MAGNETIC SHIELDS

VTI Vacuum Technologies, Inc.

MICROWAVE ABSORBERS

ARC Technologies, Inc.
ETS-Lindgren
Intermark (USA) Inc.
Kemtron Ltd.

MICROWAVE FILTERS

Cobham Microwave
EMI Filter Company
Fotofab
Instec Filters
Instruments for Industry (IFI)
LCR Electronics, Inc.

Spectrum Advanced Specialty
Products
Syfer Technology Limited

MICROWAVE POWER AMPLIFIERS

Advanced Test Equipment Rentals
AR RF/Microwave Instrumentation
Giga-tronics/Ascort Inc.
Instruments for Industry (IFI)

MIL-STD 188/125 TESTING

DNB Engineering, Inc.
Elite Electronic Engineering Co.
National Technical Systems

MIL-STD 461 / 462 TESTING

D.L.S. Electronic Systems, Inc.
DNB Engineering, Inc.
Electronics Test Centre (Kanata)
Elite Electronic Engineering Co.
EMC Compliance
Harris Corp (GCSO)
National Technical Systems
Retlif Testing Laboratories
Radiometrics Midwest Corp.
TUV SUD America Inc.
Wyle

MOBILE SHIELDED ROOMS

EMI Technologies, Inc.
Select Fabricators, Inc.
Source1 Solutions
Swift Textile Metalizing LLC

MONOPOLE ANTENNAS

ETS-Lindgren
Instruments for Industry (IFI)
Liberty Labs, Inc.
Noise Laboratory Co., Ltd.

MRI SHIELDING

Dontech, Inc.
ETS-Lindgren
MµShield Company, Inc.
Select Fabricators, Inc.

NAVLAP / A2LA APPROVED TESTING

A2LA
ATLAS Compliance & Engineering
Bay Area Compliance Labs Corp.
Compliance Management Group
D.L.S. Electronic Systems, Inc.
DNB Engineering, Inc.
Electronics Test Centre (Kanata)
Elite Electronic Engineering Co.
Liberty Labs, Inc.
National Technical Systems
NU Laboratories
Radiometrics Midwest Corp.
TUV SUD America Inc.

NETWORK ANALYZERS

Agilent Technologies, Inc.

Update, add or edit your company's information in the
EMC Buyers' Guide at www.interferencetechnology.com

PARALLEL PLATE LINE TEST SET

ETS-Lindgren
Fischer Custom Communications

PORTABLE TEST EQUIPMENT

A.H. Systems, Inc.
ETS-Lindgren
Haefely EMC
HV Technologies, Inc.
Instruments for Industry (IFI)
MPB Srl
Prostat Corp.

POWER LINE DISTURBANCE MONITOR

Voltech Instruments Ltd.

POWER LINE ELECTRONICS

Delta Products Corp.

POWER LINE FILTERS

Captor Corp.
Curtis Industries / Filter Networks
DNB Engineering, Inc.
Emission Control, Ltd.
Filter Concepts, Inc.
Genisco Filter Corp.
High & Low Corporation
Instec Filters
JINAN Filtemc Electronic Equipment Co., Ltd.
LCR Electronics, Inc.
MPE Limited
Radius Power, Inc.
Schaffner EMC, Inc.
Schurter Inc.
Syfer Technology Limited
TDK-EPC Corp.
Tri-Mag, Inc.

PRINTED CIRCUIT BOARD (PCB) FILTERS

Captor Corp.
Curtis Industries / Filter Networks
Radius Power, Inc.
Schurter Inc.
Spectrum Advanced Specialty Products
Syfer Technology Limited
Tri-Mag, Inc.

PROBES

Agilent Technologies, Inc.

PRODUCT SAFETY TESTING

D.A.R.E!! Instruments
D.L.S. Electronic Systems, Inc.
DNB Engineering, Inc.
Electronics Test Centre (Kanata)
Elite Electronic Engineering Co.
Montrose Compliance Service
National Technical Systems
Retlif Testing Laboratories
TUV SUD America Inc.

RADHAZ TESTING

DNB Engineering, Inc.
Electronics Test Centre (Kanata)
Retlif Testing Laboratories

RADIATION HAZARD METERS

ETS-Lindgren

RADIATION HAZARD PROBES

ETS-Lindgren
Instruments For Industry (IFI)

RETROFIT FILTERS & CONNECTORS

Quell Corporation
Schaffner EMC, Inc.
Schurter Inc.

RF POWER AMPLIFIERS

Advanced Test Equipment Rentals
AR RF/Microwave Instrumentation
Instruments for Industry (IFI)
Noise Laboratory Co., Ltd.
Teseq

RF POWER COMPONENTS

EM Test USA
MKS Instruments

RF POWER METERS

Agilent Technologies, Inc.
AR RF/Microwave Instrumentation
D.A.R.E!! Consultancy
ETS-Lindgren

RF SHIELDING GASKETS

ARC Technologies, Inc.
W. L. Gore & Associates, Inc.
Ja-bar Silicone Corporation
Kemtron Ltd.
P&P Technology Ltd.
Spira Manufacturing Corp.
Tech-Etch, Inc.
VTI Vacuum Technologies, Inc.

RF SHIELDING MATERIAL

Axonics, Inc.
Cybershield
Dexmet Corporation
Federal-Mogul Corporation
Systems Protection
Feuerherdt GmbH
W. L. Gore & Associates, Inc.
Intermark (USA) Inc.
Ja-bar Silicone Corporation
Kemtron Ltd.
P&P Technology Ltd.
Precision Manufacturing Group
Spira Manufacturing Corp.
Tech-Etch, Inc.
TWP Inc.
Universal Shielding Corp.

RS03 > 200 V / METER TESTING

D.L.S. Electronic Systems, Inc.
DNB Engineering, Inc.

Electronics Test Centre (Kanata)
Elite Electronic Engineering Co.
National Technical Systems
Radiometrics Midwest Corp.
Retlif Testing Laboratories
TUV SUD America Inc.

RTCA DO-160 TESTING

D.L.S. Electronic Systems, Inc.
DNB Engineering, Inc.
Electronics Test Centre (Kanata)
Elite Electronic Engineering Co.
National Technical Systems
Radiometrics Midwest Corp.
Retlif Testing Laboratories
TUV SUD America Inc.

SCIF DESIGN CONSTRUCTION & MAINTENANCE

ETS-Lindgren

SHIELDED AIR FILTERS

ETS-Lindgren
Ja-bar Silicone Corporation
Kemtron Ltd.
P&P Technology Ltd.
Spira Manufacturing Corp.
Tech-Etch, Inc.

SHIELDED BUILDINGS

ETS-Lindgren

SHIELDED CABINETS & HARDWARE

MuShield Company, Inc.
Swift Textile Metalizing LLC

SHIELDED CABLE ASSEMBLIES & HARNESSSES

Brim Electronics, Inc.
Captor Corp.
Federal-Mogul Corporation
Systems Protection
Fischer Connectors Inc.
Fotofab
W. L. Gore & Associates, Inc.
Lapp USA
MegaPhase LLC
Swift Textile Metalizing LLC

SHIELDED COMPONENTS

Federal-Mogul Corporation
Systems Protection
Ja-bar Silicone Corporation
Kensington Electronics Inc.
Schurter Inc.

Spira Manufacturing Corp.
VTI Vacuum Technologies, Inc.

SHIELDED CONDUITS

ANAMET Electrical, Inc.
Electri-Flex Company
Federal-Mogul Corporation
Systems Protection
Zero Ground LLC

SHIELDED CONNECTORS

Binder-USA
Fischer Connectors Inc.
Ja-bar Silicone Corporation
Kensington Electronics Inc.
Kycon
Lutze Inc.
PennEngineering
Schurter Inc.
Southwest Microwave, Inc.

SHIELDED DOORS

Dontech, Inc.
ETS-Lindgren
Swift Textile Metalizing LLC

SHIELDED ENCLOSURES

ClickFold Plastics
Electrorack Enclosure Products
EMP-tronic AB
IMS Engineered Products
Modpak, Inc.
MuShield Company, Inc.
Select Fabricators, Inc.
VTI Vacuum Technologies, Inc.

SHIELDED FANS

ETS-Lindgren
Spira Manufacturing Corp.

SHIELDED FUSE HOLDERS

Schurter Inc.

SHIELDED ROOM FILTERS

Captor Corp.
Dontech, Inc.
ETS-Lindgren
Fotofab
TDK-EPC Corp.

SHIELDED ROOMS

Comtest Engineering bv
ETS-Lindgren
Holland Shielding Systems BV
I. Thomas GmbH
R. A. Mayes Company, Inc.

For more information on these and other EMI/EMC companies, visit the new and improved Interference Technology EMC Buyers' Guide at www.interferencetechnology.com

Select Fabricators, Inc.

SHIELDED ROOMS, ACCESSORIES

Ad-Vance Magnetics, Inc.
Dontech, Inc.
ETS-Lindgren
Gaven Industries Inc.
Leader Tech, Inc.
National Technical Systems
Shielding Resources Group, Inc.
Swift Textile Metalizing LLC

SHIELDED ROOMS & ENCLOSURES

Alco Technologies, Inc.
Allied Moulded Products, Inc.
AR Tech
Braden Shielding Systems
Bud Industries
Captor Corp.
Comtest Engineering bv
E&C Anechoic Chambers Asia Ltd.
EMI Technologies, Inc.
EMP-tronic AB
ETS-Lindgren
Fotofab
Frankonia EMC
Global EMC Ltd.
Holland Shielding Systems BV
IMS Engineered Products
Instruments for Industry (IFI)
K-Form, Inc.
Modpak, Inc.
Noise Laboratory Co., Ltd.
ORBIT Advanced
Electromagnetics, Inc. (AEMI)
R. A. Mayes Company, Inc.
Rainford EMC Systems Ltd.
Select Fabricators, Inc.
Source1 Solutions
Spira Manufacturing Corp.
Stahlin Enclosures
Swift Textile Metalizing LLC
Videon Central Inc.
VTI Vacuum Technologies, Inc.

SHIELDED ROOMS, LEAK DETECTORS / MONITORS

ETS-Lindgren

SHIELDED SCANS, MONITORS & CRTS

Dontech Incorporated

SHIELDED SWITCHES

Schurter Inc.

SHIELDED TRANSPARENT WINDOWS

Dontech, Inc.
Instrument Plastics Ltd.
Kemtron Ltd.
P&P Technology Ltd.
Tempest Security Systems Inc.

SHIELDED TUBING

Federal-Mogul Corporation
Systems Protection
Ja-bar Silicone Corporation
Kemtron Ltd.
MuShield Company, Inc.
Zippertubing Company

SHIELDING

3M Electronics Markets
Materials Division
A&R Tarpaulins, Inc.
Alco Technologies, Inc.
Amuneal Manufacturing Corp.
ANAMET Electrical, Inc.
ARC Technologies, Inc.
Autosplice, Inc.
Axonics, Inc.
Bal Seal Engineering, Inc.
Calmont Wire & Cable, Inc.
Central Coating Company
Chomerics, Div. of Parker Hannifin Corp.
Cima NanoTech, Inc.
Connors Company
Dexmet Corporation
Dontech, Inc.
East Coast Shielding
Ed Fagan Inc.
Emerson & Cuming Microwave Products, Inc.
ETS-Lindgren
Fabritech, Inc.
Federal-Mogul Corporation
Systems Protection
Feuerherdt GmbH
Field Management Services
Fotofab
W. L. Gore & Associates, Inc.
HFC Shielding Prod. Co. Ltd.
Insulfab
Intermark (USA) Inc.
Ja-bar Silicone Corporation
JEMIC Shielding Technologies
JRE Test, LLC
Kemtron Ltd.
Magnetic Radiation Laboratories
Magnetic Shield Corporation
MAJR Products Corp.
Mekoprint A/S Chemigraphics
MH&W International Corp.
MuShield Company, Inc.
Nolato Silikonteknik
Orbel Corp.
P&P Technology Ltd.
Plastic-Metals Technologies, Inc.
Precision Manufacturing Group
RFI Controls Company
Roxtec
Rubbercraft
Saint-Gobain High Performance
Seals
SAS Industries, Inc.
Schurter Inc.
Soliani EMC SRL
Specialty Silicone Products

Spectrum Advanced Specialty Products
Spira Manufacturing Corp.
Swift Textile Metalizing LLC
Syscom Advanced Materials
Tech-Etch, Inc.
United Western Enterprises, Inc
Universal Air Filter
Universal Shielding Corp.
Vanguard Products Corp.
Vermillion, Inc.
VitaTech Electromagnetics
WaveZero, Inc.
Zero Ground LLC
Zippertubing Company
Zuken
VTI Vacuum Technologies, Inc.

SHIELDING COMPONENTS

Tech-Etch, Inc.

SHIELDING EFFECTIVENESS TESTING

D.A.R.E!! Calibrations
D.L.S. Electronic Systems, Inc.
DNB Engineering, Inc.
Dontech, Inc.
Electronics Test Centre (Kanata)
Elite Electronic Engineering Co.
ETS-Lindgren
Federal-Mogul Corporation
Systems Protection
National Technical Systems
Radiometrics Midwest Corp.
Retlif Testing Laboratories
TUV SUD America Inc.

SHIELDING FOILS

Federal-Mogul Corporation
Systems Protection
Ja-bar Silicone Corporation
Kemtron Ltd.
MuShield Company, Inc.
Tapecon, Inc.

SHIELDING MATERIAL, MAGNETIC FIELD

Federal-Mogul Corporation
Systems Protection
W. L. Gore & Associates, Inc.
Ja-bar Silicone Corporation
Kemtron Ltd.
Less EMF Inc.
Magnetic Shield Corporation
MuShield Company, Inc.
Spira Manufacturing Corp.
Vacuum Schmelze GmbH & Co.
VTI Vacuum Technologies, Inc.

SIGNAL GENERATORS

Agilent Technologies, Inc.
AR RF/Microwave Instrumentation
D.A.R.E!! Consultancy
Praxsym, Inc.
York EMC Services Ltd.

SIGNAL LINE FILTERS

Captor Corp.
Curtis Industries / Filter Networks
EMI Filter Company
ETS-Lindgren
Instec Filters
Spectrum Advanced Specialty Products
Syfer Technology Limited
TDK-EPC Corp.
WEMS Electronics

SIGNAL LINE ISOLATION TRANSFORMERS

Kensington Electronics, Inc.

SIMULATION SOFTWARE

EM Software & Systems
EMS-Plus

SITE ATTENUATION TESTING

D.A.R.E!! Calibrations
D.L.S. Electronic Systems, Inc.
DNB Engineering, Inc.
Electronics Test Centre (Kanata)
ETS-Lindgren
National Technical Systems
Radiometrics Midwest Corp.
Retlif Testing Laboratories

SITE SURVEY SERVICES

D.A.R.E!! Calibrations
D.L.S. Electronic Systems, Inc.
DNB Engineering, Inc.
Electronics Test Centre (Kanata)
Elite Electronic Engineering Co.
ETS-Lindgren
Kimmel Gerke Associates, Ltd.
National Technical Systems
Radiometrics Midwest Corp.
Retlif Testing Laboratories

SOLID STATE AMPLIFIERS

AE Techtron, Inc.
AR RF/Microwave Instrumentation
Instruments for Industry (IFI)

SPECTRUM ANALYZERS

Agilent Technologies, Inc.
ValueTronics International, Inc.

SPREAD SPECTRUM PRODUCTS

Mercury United Electronics Inc.
SiTime Corp.

STANDARDS TRANSLATIONS

Advanced Programs, Inc.
ANDRO Computational Solutions
Electronics Test Centre (Kanata)
PGMC Ltd
TUV SUD America Inc.

STATIC CONTROL MATERIALS & EQUIPMENT

Advanced Test Equipment Rentals

Swift Textile Metalizing LLC

SUPPRESSORS

ARC Technologies, Inc.
Captor Corp.
Fair-Rite Products Corp.
Fischer Custom Communications
Kemtron Ltd.

SURGE & TRANSIENTS

ACL Staticide
Advanced Test Equipment Rentals
Alltec Corporation
AMS
ARC Technologies, Inc.
Avalon Test Equipment Corp.
CITEL Inc.
EM Test USA
EMC Partner AG
Haefely EMC
HV Technologies, Inc.
Intermark (USA) Inc.
Kikusui America Inc.
L. Gordon Packaging
Liberty Labs, Inc.
MCG Surge Protection
Nextek
Noise Laboratory Co., Ltd.
Okaya Electric America, Inc.
Pearson Electronics, Inc.
Phoenix Contact
RTP Company
Schurter Inc.
Swift Textile Metalizing LLC
Transtector Systems Inc.

SURGE PROTECTION

Alltec Corporation
Bourns Inc.
Captor Corp.
MCG Surge Protection
Metatech Corporation
Phoenix Contact
Schurter Inc.

TELCORDIA TESTING

D.L.S. Electronic Systems, Inc.
DNB Engineering, Inc.
Electronics Test Centre (Kanata)
National Technical Systems
Radiometrics Midwest Corp.

TELECOMMUNICATIONS TEST NETWORKS

Agilent Technologies, Inc.
EMC Partner AG
HV Technologies, Inc.

TEM CELLS

ASR Technologies Inc.
ETS-Lindgren
Fischer Custom Communications
Instruments for Industry (IFI)
Noise Laboratory Co., Ltd.

TEMPEST FILTERS

Captor Corp.

Curtis Industries / Filter Networks
Dontech, Inc.
Syfer Technology Limited
Spectrum Advanced Specialty
Products

TEMPEST SUPPRESSED PRODUCTS

Dontech Incorporated

TEMPEST TEST EQUIPMENT

A.H. Systems, Inc.
Fischer Custom Communications

TEMPEST TESTING

National Technical Systems

TEST ACCESSORIES

AR RF/Microwave Instrumentation
CST of America, Inc.
EM Test USA
EMC Partner AG
EMCO Elektronik GmbH
ETS-Lindgren
Fischer Custom Communications
Instruments for Industry (IFI)
TDK-Lambda Americas

TEST ANTENNAS

Advanced Test Equipment Rentals
A.H. Systems, Inc.
AR RF/Microwave Instrumentation
Electro-Metrics Corp.
Instruments for Industry (IFI)
Teseq

TEST CAPACITORS

Captor Corp.

TEST EQUIPMENT, LEASING & RENTAL

A.H. Systems, Inc.
Advanced Test Equipment Rentals
AR RF/Microwave Instrumentation
Instruments for Industry (IFI)

TEST EQUIPMENT, REPAIR & CALIBRATION

A.H. Systems, Inc.
Adler Instrumentos SL
Agilent Technologies, Inc.
D.A.R.E!! Consultancy
Electronic Instrument Associates
Embassy Global, LLC
EMC Partner AG
EMSCAN
ETS-Lindgren
Fischer Custom Communications
Instruments for Industry (IFI)
Seibersdorf Labor GmbH

TEST INSTRUMENTATION

A.H. Systems, Inc.
Aaronia AG
Accurate Controls Ltd.
Adler Instrumentos SL
Advanced Test Equipment Rentals

Aeroflex
Agilent Technologies, Inc.
All-Spec Industries
Alltest Instrument, Inc.
Amstat Industries, Inc.
Anritsu Company
Apogee Labs Inc.
APREL Laboratories
AR RF/Microwave Instrumentation
ASR Technologies Inc.
AWR Corporation
Barth Electronics, Inc.
Bird Technologies Group / TX RX
Systems
Circuit Insights LLC
Combinova AB
Compliance West, USA
CST of America, Inc.
D.A.R.E!! Consultancy
D.A.R.E!! Instruments
Ecliptek Corp.
EM Software & Systems
EM Test USA
Embassy Global, LLC
EMC Partner AG
EMSCAN
emscreen GmbH
EMSS Consulting Pty (Ltd.)
emv - Elektronische Meßgeräte
Vertriebs GmbH
Ergonomics, Inc.
ETS-Lindgren
Fischer Custom Communications
Fotofab
GAUSS Instruments
Haefely EMC
HV Technologies, Inc.
Inceleris
Instruments for Industry (IFI)
Langer EMV-Technik GmbH
Laplace Instruments Ltd.
Liberty Labs, Inc.
Macton
Michigan Scientific Corp.
Micronor Inc.
Mihajlo Pupin Institute-EMC Lab
Montena Technology sa
MPB Srl
Narda Safety Test Solutions S.r.l.
NEDC Fabricating Solutions
Noise Laboratory Co., Ltd.
Pearson Electronics, Inc.
Potomac Instruments Inc.
PPM (Pulse Power &
Measurement) Ltd.
Praxsym, Inc.
Protek Test and Measurement
Ramsey Electronics
Rohde & Schwarz USA, Inc.
Saelig Company
Safe Engineering Services &
Technologies, Ltd.
Safety Test Technology Co., Ltd
Seibersdorf Labor GmbH
Sensor Products Inc.
Shanghai Empek
Electromagnetic Technology
Ltd.
SILENT Solutions

SimLab Software GmbH
Solar Electronics Co.
Suzhou 3CTEST Electronic Co.,
Ltd.
TE Connection Asia
TESEO
Teseq
Thermo Fisher Scientific
TREK, INC.
ValueTronics International, Inc.
Wavecontrol

TEST SOFTWARE

Averna
D.A.R.E!! Consultancy
NEXIO
CST of America, Inc.

TESTING

3C Test Ltd. - EMC Testing
A.H. Systems, Inc.
A2LA
Acme Testing Company
Advanced Compliance Solutions,
Inc.
Advanced Testing Services
AERO NAV Laboratories
AHD EMC Lab / Amber Helm
Development L.C.
Alion Science and Technology
American Environments Co., Inc.
Applied Physical Electronics, L.C.
ATLAS Compliance &
Engineering
BEC Inc.
Blackwood Labs
Blue Guide EMC Lab
Braco Compliance Ltd.
Bureau Veritas (formerly Curtis-
Straus)
Cascade TEK
CertifiGroup
CETECOM Inc.
CKK Laboratories, Inc.
Communication Certification
Laboratory
Compatible Electronics, Inc.
Compliance Certification
Services
Compliance Engineering Ireland
Ltd.
Compliance Management Group
Compliance Testing LLC
Compliance Worldwide
Core Compliance Testing
Services
Cranage EMC Testing Ltd.
Criterion Technology, Inc.
CSA International
Custom Assembly LLC
D.A.R.E!! Calibrations
D.L.S. Electronic Systems, Inc.
Dayton T. Brown, Inc.
dBi Corp.
Diversified T.E.S.T. Technologies
DNB Engineering, Inc.
Don HEIRMAN Consultants
E.F. Electronics Co.

E-Labs Inc.
 ElectroMagnetic Investigations, LLC
 Electro Magnetic Test, Inc.
 Electro Rent Corporation
 Elite Electronic Engineering Co.
 EM Software & Systems
 EMC Compliance
 EMC Integrity, Inc.
 EMC Technologies Pty Ltd.
 EMC Tempest Engineering
 EMC Testing Laboratories, Inc.
 EMCC Dr. Rasek
 EMC/MCC
 EMF Testing USA
 EMField
 EMITECH
 Enerdoor Inc.
 Engineered Testing Systems
 Environ Laboratories, LLC
 ETS-Lindgren
 Fabreeka International, Inc.
 Federal-Mogul Corporation
 Systems Protection
 Global Advantage
 Global Certification Laboratories, Ltd.
 Global Testing
 Green Mountain
 Electromagnetics, Inc.
 GTN GmbH & Co. KG
 H.B. Compliance Solutions
 Harris Corp (GCSO)
 Hermon Laboratories
 iNARTE, Inc.
 Ingenium Testing, LLC
 International Certification
 Services, Inc.
 International Compliance
 Laboratories, LLC
 Intertek Testing Services
 IQS, a Div. of The Compliance
 Management Group
 ITC Engineering Services, Inc.
 Jacobs Technology Inc.
 JS TOYO Corporation (Shenzhen)
 Ltd.
 Keystone Compliance
 Kimmel Gerke Associates, Ltd.
 L.S. Research
 L-3 Communications Cincinnati
 Electronics
 Laboratory Testing Inc.
 Langer EMV-Technik GmbH
 L F Research EMC
 Liberty Labs, Inc.
 Little Mountain Test Facility
 Mesago Messe Frankfurt GmbH
 MIRA Ltd.
 National Technical Systems
 Naval Air Systems Command
 Naval Air Warfare Center
 NCEE Labs
 Nemko USA
 Northwest EMC, Inc.
 NU Laboratories
 Paladin EMC
 Parker EMC Engineering
 Peak Electromagnetics Ltd.

Pearson Electronics, Inc.
 Percept Technology Labs, Inc.
 Philips Applied Technologies -
 EMC Center
 Philips Innovation Services-EMC
 Center
 Pioneer Automotive
 Technologies, Inc. - EMC Lab
 Power-Electronics Consulting
 Product Safety Engineering Inc.
 Protocol Data Systems Inc.
 Pulver Laboratories Inc.
 QinetiQ
 Qualtest Inc.
 Radiometrics Midwest Corp.
 Remcom Inc.
 Restor Metrology
 Retlif Testing Laboratories
 RF Exposure Lab, LLC
 RFI Global Services Ltd.
 RFTEK
 Rhein Tech Laboratories, Inc.
 Rogers Labs, Inc.
 Rubicom Systems, A division of
 ACS
 SAE Power
 Seven Mountains Scientific, Inc.
 (ENR)
 SGS
 SIEMIC
 Southwest Research Institute
 SPAWAR Systems Center
 Atlantic
 Swift Textile Metalizing LLC
 Sypris Test and Measurement
 TEMPEST Inc.
 Teseq
 Test Site Services Inc.
 The Compliance Management
 Group
 Timco Engineering, Inc.
 TRaC Global
 Trialon Corp.
 TUV Rheinland Of North America
 TUV SUD America Inc.
 TÜV SÜD Product Service Ltd.
 TÜV SÜD SENTON GmbH
 Ultratech Group of Labs
 Underwriter's Laboratories Inc.
 Walshire Labs, LLC
 Washington Laboratories, Ltd.
 White Sands Missile Range
 Willow Run Test Labs, LLC
 Wyle
 Yazaki Testing Center
 D.A.R.E!! Instruments

TESTING LABORATORIES

Alion Science and Technology
 AT4 Wireless
 Blue Guide EMC Lab
 Compliance Testing LLC
 Compliance Worldwide
 D.A.R.E!! Instruments
 D.L.S. Electronic Systems, Inc.
 Diversified T.E.S.T. Technologies
 DNB Engineering, Inc.
 Don HEIRMAN Consultants

Electro Magnetic Test, Inc.
 Electronics Test Centre (Kanata)
 Elite Electronic Engineering Co.
 EMC Integrity, Inc.
 EMC Technologies Pty Ltd.
 H.B. Compliance Solutions
 International Compliance
 Laboratories, LLC
 Keystone Compliance
 Langer EMV-Technik GmbH
 Liberty Labs, Inc.
 National Technical Systems
 Partnership for Defense Innovation
 Professional Testing (EMI), Inc.
 Qualtest Inc.
 Radiometrics Midwest Corp.
 Retlif Testing Laboratories
 RMV Technology Group, LLC
 SDP Engineering Inc.
 SIEMIC
 Sprinkler Innovations
 Stork Garwood Laboratories Inc.
 Test Site Services Inc.
 Tranzeo EMC Labs Inc.
 TÜV SÜD America Inc.
 TÜV SÜD Product Service Ltd.
 TÜV SÜD SENTON GmbH
 World Cal, Inc.

TRAINING, SEMINARS & WORKSHOPS

A2LA
 Andre Consulting, Inc.
 Cherry Clough Consultants Ltd
 CST of America, Inc.
 D.L.S. Electronic Systems, Inc.
 Don HEIRMAN Consultants
 EM Software & Systems
 EMC Engineering and Safety
 EMC Goggles Ltd.
 Euro EMC Service (EES)
 Fotofab
 Gaddon Consultants
 Henry Ott Consultants
 Hoolihan EMC Consulting
 Integrated Engineering Software
 Jastech EMC Consulting, LLC
 Kimmel Gerke Associates, Ltd.
 M.MARDIGUIAN, EMC Consulting
 Montrose Compliance Service
 National Technical Systems
 QEMC - Engenharia,
 Qualidade e Compatibilidade
 Eletromagnética Ltda.
 Retlif Testing Laboratories
 Siberian Inc.

Spec-Hardened Systems
 Stephen Halperin & Associates
 Teseq
 TUV SUD America Inc.

TRANSIENT DETECTION & MEASURING EQUIPMENT

Advanced Test Equipment Rentals
 Circuit Insights LLC
 Pearson Electronics, Inc.
 Rohde & Schwarz USA, Inc.

TRANSIENT GENERATORS

Advanced Test Equipment Rentals
 EM Test USA
 EMC Partner AG
 Fischer Custom Communications
 Haefely EMC
 HV Technologies, Inc.
 Noise Laboratory Co., Ltd.
 Teseq
 Transient Specialists, Inc.

TRANSIENT SUPPRESSORS

Captor Corp.
 Littlefuse Inc.
 TDK-EPC Corp.

TRAVELING WAVE TUBE (TWT) AMPLIFIERS

Applied Systems Engineering, Inc.
 AR RF/Microwave Instrumentation
 CPI (Communications & Power
 Industries)
 Instruments for Industry (IFI)
 Quarterwave Corporation
 TMD Technologies Ltd.

TURNTABLES

ETS-Lindgren
 Macton

UNINTERRUPTED POWER SYSTEM

APC by Schneider Electric

VOLTAGE PROBES

Fischer Custom Communications
 Haefely EMC

WIRE & CABLE FILTERS

Captor Corp.
 Spectrum Advanced Specialty
 Products

For more information on these and other EMI/EMC companies, visit the new and improved Interference Technology EMC Buyers' Guide at www.interferencetechnology.com

COMPANY DIRECTORY

Manufacturers, consultants, and service organizations active in the electromagnetic interference field are listed in this directory. To learn how to be included in this directory, e-mail info@interferencetechnology.com.

0-9

3C Test Ltd. - EMC Testing

Silverstone Technology Park, Silverstone Circuit, Towcester, Northampton NN12 8GX, United Kingdom; +44 (0) 1327 857500; Fax: +44 (0) 1327 857747; sales@3ctest.co.uk; www.3ctest.co.uk

3Gmetalworx World

101 Planchet Road, Concord L4K 2C6, Canada; 905-738-7973; MGomez@3gmetalworx.com; www.3gmetalworx.com

3M Electronics Markets Materials Division

6801 River Place Blvd., Austin, TX 78726-9000, USA; 800-245-0329; Alex.Gwin@kolarmail.com; www.3M.com/electrical

A

A&R Tarpaulins, Inc.

16246 Valley Blvd., Fontana, CA 92335 USA; 909-829-4444; jessica@artech2000.com; www.artarps.com

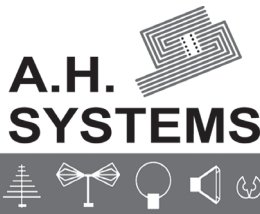

A.H. Systems, Inc. Inside Front Cover, 17

9710 Cozycroft Ave., Chatsworth, CA 91311 USA; 818-998-0223; Fax: 818-998-6892; sales@ahsystems.com; www.AHSystems.com; Arthur C. Cohen, Pres.; Travis Samuels, Ops. Dir.

AL	T & M Solutions	770-973-7492
AR	Southwest Electronic Ind., Inc.	972-523-0017
GA	T & M Solutions	770-973-7492
LA	Southwest Electronic Ind., Inc.	972-523-0017
OK	Southwest Electronic Ind., Inc.	972-523-0017
TN	T & M Solutions	770-973-7492
TX	Richardson, Southwest Electronics Ind.	972-523-0017

INTERNATIONAL

AUS	Sydney, Test & Measurement Australia PTY Limited	61-2-4739-9523
AUT	Ludwigsburg, ProNova Elektronik GmbH	49-7141-2858-20
BEL	Lelystad, EEMCCoimex	31-320-295-395
BGR	Sofia, Test Solutions	359 2 970 1990
BOL	Alianza S.E.T.	305-767-4000
CHE	Ludwigsburg, ProNova Elektronik GmbH	49-7141-285820
CHN	Beijing, EMC Technology Ltd.	86-10-8267-5757
	Beijing, Compliance Direction Systems, Inc.	86-10-6846-0592
COL	Alianza S.E.T.	305-767-4000
CRI	Alianza S.E.T.	305-767-4000
DEU	Ludwigsburg, Pro Nova Elektronik GmbH	49-7141-2858-20
ECU	Alianza S.E.T.	305-767-4000
ELS	Alianza S.E.T.	305-767-4000
FRA	Gennevilliers, AR France	33-147-91-7530
GRB	Bedfordshire, SystemWare Europe	44-1462-734777
GRC	Vector Technologies Ltd.	30-210-68-58008
GUA	Alianza S.E.T.	305-767-4000
HND	Alianza S.E.T.	305-767-4000
IDN	Singapore Technologies Electronics LTD	65-6413-3119
IND	TTL Technologies Pvt. Ltd.	91-80-25251859
ISR	Kfar-Saba, Wave Technologies	972-9-764-4878
ITA	Segrate, Narda Safety Test Solutions	39-02-269 9871
	Druento, Teseo S.p.A.	011-39-99-41-911
JPN	Tokyo, Techno Science Japan Corp.	81-3-5717-6130
KOR	Seoul, Taehung Trading Inc.	82-2-541-2825
LUX	EEMCCoimex	31-320-295-395

MYS	Singapore Technologies Ltd.	65-6413-3119
NCA	Alianza S.E.T.	305-767-4000
NLD	Lelystad, EEMCCoimex	31-320-295-395
PAN	Alianza S.E.T.	305-767-4000
POL	Warszawa, AM Technologies	48 22 532 2800
ROU	Bucharest, Celesta Comexim SRL	4021-410-30-64
RUS	Moscow, Sernia Ltd.	7 495 225 40 14
SGP	Singapore Technologies Ltd.	65-6413-3119
SPN	Barcelona	34-933208055
SWE	Ageto MTT AB	46-0-8-446-7730
THA	Singapore Technologies Ltd.	65-6413-3119
TUR	Izmir, Norana	90-232-464-0011
TWN	New Taipei City, Superlink Technology Corp.	886-2-2698-3456
VZL	Alianza S.E.T.	305-767-4000



A2LA - American Assoc. for Laboratory Accreditation

5301 Buckeystown Pike, Frederick, MD 21704 USA; 301-644-3217; Fax: 301-662-2974; Adam.Gouker, agouker@A2LA.org; www.A2LA.org

Aaronia AG

Gewerbegebiet Aaronia AG, Strickscheid, DE-54597 Euscheid, Germany; +49 (0) 6556 93033; Fax: +49 (0) 6556 93034; www.aaronia.de

Accurate Controls Ltd.

25 Cowley Road, Nuffield Industrial Estate, Poole, Dorset, United Kingdom; +44 (0) 1202 678108; www.accurate-controls.ltd.uk

ACL Inc.

1960 E. Devon Ave., Elk Grove Village, IL 60007 USA; 847-981-9212; 800-782-8420; marykay@aclstatomic.com; www.aclstatomic.com

ACL Staticide

840 W. 49th Place, Chicago, IL 60609; 847-981-9212; info@aclstatomic.com; www.aclstatomic.com

Acme Testing Company

2002 Valley Highway, Acme, WA 98220 USA; 360-595-2785; 888-226-3837; Fax: 360-595-2722; acmetest@acmetesting.com; www.acmetesting.com

ACS Industries, Inc.

One New England Way, Lincoln, RI 02865 USA; 401-769-4700; Fax: 401-333-2294; jbuckler@acsind.com; www.acsindustries.com/products/industrial-applications/EMI-RFI_Shielding/default.html

Adams Magnetic Products Co.

807 Mantoloking Road, Suite 203, Brick NJ 08723 USA; 732-451-0123; 800-275-6312; www.adamsmagnetic.com

Adhesives Research, Inc.

400 Seaks Run Road, P.O. Box 100, Glen Rock, PA 17327 USA; 717-235-7979; 800-445-6240; Fax: 717-235-8320; jgumerlock@arglobal.com; www.adhesivesresearch.com

Adler Instrumentos SL

C/ Antonio de Cabezón, 83, Madrid, Madrid 28034 Spain; 34913584046; Fax: 34913581383; millan@adlerinstrumentos.es; www.adler-instrumentos.es

Ad-Vance Magnetics, Inc.

625 Monroe St., P. O. Box 69, Rochester, IN 46975 USA; 574-223-3158; Fax: 574-223-2524; rick@advancemag.com; www.advancemag.com

Advanced Compliance Solutions, Inc.

5015 B.U. Bowman Drive, Buford, GA 30518 USA; 770-831-8048; 770-831-8598; sproffit@acstestlab.com; www.acstestlab.com

Advanced Monolithic Ceramics, Inc.

3101 Constitution Ave., Olean, NY 14760 USA; 716-372-5225; Fax: 716-372-5467; info@sc.rr.com; www.amccps.com

Advanced Programs, Inc.

7125 Riverwood Drive, Columbia, MD 21046; 800-445-6240; 410-312-5800; Fax: 410-312-5850; service@advprograms.com; www.advprograms.com



Advanced Test Equipment Rentals

The Knowledge. The Equipment. The Solution.

Advanced Test Equipment Rentals 50

10401 Roselle St., San Diego, CA 92121 USA; 888-554-ATEC(2832); Fax: 858-558-6570; rentals@ATECcorp.com; www.ATECcorp.com

Advanced Testing Services

9420 San Mateo Blvd. NE, Suite C, Albuquerque, NM 87113 USA; 505-292-2032; 877-292-2031; Fax: 505-237-8430; sales@advanced-testing.com; www.advanced-testing.com

AE TECHRON

Precision Industrial Amplifiers

AE Technon, Inc.

2507 Warren St., Elkhart, IN 46516 USA; 574-295-9495; Fax: 543-295-9496; Terri.Clark, sales@aetechnon.com; www.aetechnon.com

AEF Solutions

Unit 46, Thomas Way, Lakesview Business Park, Hersden Canterbury Kent CT3 4JJ UK; +44 1227 711455; Fax: +44 2380 455022; Paul.Lawrence, paul@aefolutions.com; www.aefolutions.com

AEM, Inc.

6610 Cobra Way, San Diego, CA 92121 USA; 858-481-0210; Fax: 858-481-1123; Scott.Sentz, hrccsales@aem-usa.com; www.aem-usa.com

AEMC Instruments, Inc.

200 Foxborough Blvd., Foxborough, MA 02035 USA; 508-698-2115; Fax: 508-698-2118; www.aemc.com

AERO NAV Laboratories

14-29 112 St., College Point, NY 11356 USA; 718-939-4422; 800-680-6608; Fax: 718-539-3719; SLevine_sales@aeronavlabs.com; www.aeronavlabs.com

Aerodev Electromagnetic Tech

19525 Talavera Lane, Edmond, OK 73012 USA; 405-760-6064; Fax: 405-285-6572; www.aerodev.com

Aeroflex

35 South Service Road, P.O. Box 6022, Plainview, NY 11803 USA; 516-694-6700; 800-843-1553; Fax: 516-694-2562; info-test@aeroflex.com; www.aeroflex.com



Agilent Technologies

Agilent Technologies, Inc. 15
5301 Stevens Creek Blvd., Santa Clara, CA 95051 USA; 800-829-4444; www.agilent.com

AHD EMC Lab / Amber Helm Development L.C.

92723 Michigan Hwy 152, Sister Lakes, MI 49047 USA; 269-429-8352; 888-847-8027; Fax: 269-429-9016; ghelm@ahde.com; www.ahde.com

Albatross Projects GmbH

Daimlerstraße 17, 89564 Nattheim, Germany; +49 7321 730510; Fax: +49 7321 730590; info@albatross-projects.com; www.albatross-projects.com

Alchemetal

3327 80 St., Suite 2, New York, NY 11372 USA; 917-297-3560; egreenwood@alchemetal.com; www.alchemetal.com



ALCO TECHNOLOGIES

Alco Technologies, Inc.

1815 W. 213th St. #175, Torrance, CA 90501 USA; 310-328-4770; Fax: 310-328-1262; alcotech@alcotech.com; www.alcotech.com

Alion Science & Technology

20 Clipper Road, West Conshohocken, PA 19428 USA; 610-825-1960, ext. 229; Fax: 610-825-1684; Rohit Vohra, rvohra@alionscience.com; www.alionscience.com

All-Spec Industries

5228 US Hwy 421 N, Wilmington, NC 28401 USA; 800-537-0351; 910-763-5664; sales@allspec.com; www.all-spec.com

Allied Components International

14712 Sinclair Circle, Tustin, CA 92780 USA; 714-665-1140; Fax: 714-665-1150; Mark Rigel, mrr@alliedcomponents.com; www.alliedcomponents.com

Allied Moulded Products, Inc.

222 North Union St., Bryan, OH 43506 USA; 419-636-4217; sales@alliedmoulded.com; www.alliedmoulded.com

Alltec Corporation

64 Catalyst Drive, Canton, NC 28716 USA; 828-646-9290; Fax: 828-646-9527; Marketing, marketing@allteccorp.com; www.allteccorp.com

Alltest Instrument, Inc.

1310 S. Roller Road, Ocean, NJ 07712 USA; 732-695-0800; 800-251-0706; Fax: 732-695-0801; harvey@alltest.us; www.alltest.us

ALX Technical

630 Rivermede Road, Unit 9, Concord, Ontario, L4K 2H7 Canada; 905-761-0370; www.alxtechnical.com

Amber Technologies

4 Oxford Las, Smithtown, NY 11787 USA; 631-724-4619; Fax: 631-361-4836; rsjaniec@aol.com

American Environments Co., Inc.

17 Commercial Blvd., Medford, NY 11763 USA; 631-736-5883; Fax: 631-736-5272; wmilller49@optonline.net; www.aeco.com

Americor Electronics, Ltd.

675 S. Lively Blvd., Elk Grove Village, IL 60007 USA; 800-830-5337; Fax: 847-956-0300; www.americor-usa.com

Amphenol Canada Corp.

20 Melford Drive, Scarborough, Ontario M1B 2X6, Canada; 416-291-4401; Fax: 416-292-0647; sales@amphenolcanada.com; www.amphenolcanada.com

Amphenol Industrial Operations

40-60 Delaware Ave., Sidney, NY 13838 USA; 800-678-0141; Fax: 607-563-5157; www.amphenol-industrial.com

AMS

9119 Cross Park Drive, Knoxville, TN 37923 USA; 865-691-1756; Fax: 865-691-9344; brad@ams-corp.com; www.ams-corp.com

Amstat Industries, Inc.

3012 N. Lake Terrace, Glenview, IL 60026 USA; 847-998-6210; Fax: 847-998-6218; Larry Jacobson, amstat@sbcglobal.net; www.amstat.com

Amuneal Manufacturing Corp.

4737 Darrah St., Philadelphia, PA 19124 USA; 215-535-3000; 800-755-9843; Fax: 215-743-1715; info@amuneal.com; www.amuneal.com

ANAMET Electrical, Inc.

1000 Broadway Ave. East, Mattato, IL 61938 USA; 720-348-2933; Fax: 720-348-2934; Don Coffey, don@anametelectrical.com; www.anametelectrical.com

Andre Consulting, Inc.

12812 NE 185th Court, Bothell WA 98011-3121 USA; 720-348-2933; Fax: 720-348-2934; Patrick G. Andre, pat@andreconsulting.com; http://andreconsulting.com

ANDRO Computational Solutions, LLC

Beeches Professional Campus, Bldg 2 Suite 1, 7902 Turin Road, Rome, NY 13440-2067 USA; 315-334-1163; Fax: 315-334-1397; androcs@androcs.com; www.androcs.com

Anritsu Company

1155 East Collins Blvd., Suite 100, Richardson, TX 75081 USA; 972-644-1777; 800-267-4878; Fax: 972-671-1877; gina.varela@anritsu.com; www.us.anritsu.com

Antistatic Industries of Delaware

11 Deerpark Drive, Suite 102 B, Monmouth Junction, NJ 08852-1923 USA; 732-274-0001; 800-214-7900; Fax: 732-438-9152; aexstatic@aol.com; www.antistaticindustries.com

Apache Design Solutions

2645 Zanker Road, San Jose, CA 95134 USA; 408-457-2000; Fax: 408-428-9569; apache_sales@apache-da.com; www.apache-da.com

APC by Schneider Electric

132 Fairgrounds Road, W. Kingston, RI 02892 USA; 800-788-1704; www.apc.com

Apex Die & Gasket Inc.

P.O. Box 1442, Tempe, AZ 85280-1442 USA; 480-894-1112; 888-937-3907; dave@apexdc.com; www.dieandgasket.com

API Delevan

270 Quaker Road, East Aurora, NY 14052 USA; 716-652-3600; Fax: 716-652-4814; apisales@delevan.com; www.delevan.com

Apogee Labs Inc.

210 S. Third St., North Wales, PA 19454 USA; 215-699-2060; dhendricks@apogeeelabs.com; www.apogeeelabs.com

Applied Electromagnetic Technology LLC

P.O. Box 1437, H.G. Trueman Road, Solomons, MD 20688 USA; 410-326-6728; info@appliedemtech.com; www.appliedemtech.com

Applied Physical Electronics, L.C.

P.O. Box 341149, Austin, TX 78734 USA; 512-264-1804; Fax: 512-264-1784; rschreib@apelc.com; www.apelc.com

Applied Systems Engineering

7510 Benbrook Parkway, Fort Worth, TX 76126 USA; 817-249-4180; Fax: 817-249-3413; B.Jostrand, bjostrand@appls.com; appls.com

APREL Laboratories

17 Bentley Ave., Nepean, Ontario K2E 6T7, Canada; 613-820-2730; Fax: 613-820-4161; www.aprel.com



AR Receiver Systems

21434 Osborne St., Canoga Park, CA 91304-1520; 818-882-3977; Fax: 818-882-3981; info@arworld.us; www.arworld.us. Products are purchased through AR RF/Microwave Instrumentation.

AR RF/Microwave Instrumentation 7, 47

160 School House Road, Souderton, PA 18964 USA; 215-723-8181; 800-933-8181; info@arworld.us; www.arworld.us

AK	Syntek	503-614-3403
AL	Brennan Associates	727-445-5006
AR	Testech Sales Engineers	972-644-5010
AZ	Technical Marketing Specialists	480-929-0009
CA	Altamont Technical Services	925-294-9774
CO	Technical Marketing, Inc.	303-488-0220
CT	R.J. Sickles Associates	781-862-5100
DC	Delmarva Engineering	410-990-9000
DE	Advanced Technical Marketing	800-310-8805
FL	Brennan Associates	727-446-5006
GA	Brennan Associates	770-402-2560
IA	Electronic Instrument Associates Inc.	630-924-1600
ID	Syntek	425-822-7777
IL	Electronic Instrument Associates Inc.	630-924-1600
IN	Delta Technology Solutions	513-310-6287
KS	KJS Marketing	816-578-4751
KY	Delta Technology Solutions	513-310-6287
LA	Testech Sales Engineers	972-644-5010
MA	R.J. Sickles Associates	781-862-5100
MD	Delmarva Engineering	410-990-9000
ME	R.J. Sickles Associates	781-862-5100
MI	Delta Technology Solutions	248-420-9145
MN	Electronic Instrument Associates Inc.	612-695-4055
MO	KJS Marketing	816-578-4751
MS	Brennan Associates	727-446-5006
MT	Syntek	425-822-7777
NC	Delmarva Engineering	410-990-9000
NH	R.J. Sickles Associates	781-862-5100
NJ	Advanced Technical Marketing	800-310-8805
NM	Technical Marketing Specialists	505-286-0079
NV	Altamont Technical Services	925-294-9774
NY	Advanced Technical Marketing	800-310-8805
NY	GSC Representatives	585-385-1170
OH	Delta Technology Solutions	614-582-4469
OK	Testech Sales Engineers	817-282-4471
OR	Syntek	503-614-3403
PA	Advanced Technical Marketing	800-310-8805
RI	R.J. Sickles Associates	781-862-5100
SC	Brennan Associates	770-402-2560
TN	Brennan Associates	770-402-2560
TX	Testech Sales Engineers	972-644-5010
UT	Technical Marketing Specialists	801-944-5605
VA	Delmarva Engineering	410-990-9000
WA	Syntek	425-822-7777
WI	Electronic Instrument Associates Inc.	630-924-1600

INTERNATIONAL

ARG	Instrumental Tech	54-11-6397-8329
AUS	Faraday Pty Ltd	61-3-9729-5000
AUT	EMV GmbH	49-89-614-1710
BLR	Giga Electronics Eood	359-2-971-4919
BLG	AR Benelux B.V.	31-172-423000
BRA	Boreal Communications	55-19-3258-2210
CAN	Source Engineering	519-654-8511
CHL	Tecel Ltda	56-2-334-1332
CHN	Corad Technology Ltd.	852-2793-0330
CZE	H Test a.s.	420-235-366-308
DNK	Erik Blichfeld	45-7552-2020
FIN	Caltest Oy	358-9-530-6070
FRA	AR France	33-1-4791-7530
GER	EMV GmbH	49-89-614-1710
GRC	Vector Technologies Ltd.	30-210-6858008

HKG	Corad Technology Ltd.	852-2793-0330
HUN	H Test a.s.	420-235-366-308
IND	Complus Sys. Pvt. Ltd.	91-80-416-83883
ISR	Eratel Electronics, Ltd.	972-9-7663478
ITA	Teseo SpA	39-011-994-1911
JPN	Nippon Automatic Control	81-3-5434-1600
KOR	EMC Solution	82-070-7805-5100
LUX	AR Benelux B.V.	31-172-423000
MYS	Precision Technologies PTE, Ltd.	65-6-2734573
MEX	Sistemas e Ingenieria de EMC	52-55-2168-2148
NLD	AR Benelux B.V.	31-172-423000
NZL	Faraday Pty Ltd.	61-3-9729-5000
NOR	Nortelco A/S	47-2257-6124
PAK	Telec Electronics & Machinery Ltd.	92-21-5217201
POL	Urządzenia Elektroniczne Import	48-022-313-1735
PRT	Wavecontrol	34-93-320-8055
ROM	COMTEST SRL	4021-2110883
RUS	Radiant-Elcom	7495-725-0404
SGP	Precision Technologies PTE, Ltd	65-6-2734573
SAF	Protea Technology, Ltd.	27-11-719-5791
SPA	Wavecontrol, S.L.	34-93-320-8055
SWE	CE-BIT Elektronik AB	46-8-735-7550
SWZ	Emitec AG	41-41-748-6010
TAI	Evergo Instruments	886-2-2752-0767
THA	Anatron Co. Ltd.	60-2-732-0902
TUR	Orko Mumessilik	90-312-438-2213
UK	AR United Kingdom	441-908-282766

AR Tech

16246 Valley Blvd, Fontana, CA 92335 USA; 909-829-4444; Fax: 909-829-0564; Bud Weisbart, mail@artech2000.com; www.artech2000.com

ARA Technologies

P.O. Box 226, Smithtown, NY 11787 USA; 631-724-4619; Fax: 631-361-8691; emc@aratech-inc.com

ARC Technologies, Inc. 89

11 Chestnut St., Amesbury, MA 01913 USA; 978-388-2993; Fax: 978-388-6866; sales@arc-tech.com; www.arc-tech.com

Arcotronics, Inc.

20-1 Jules Court, Bohemia, NY 11716 USA; 631-563-9568; Fax: 631-563-9569; rich@arcotronics.net; www.arcotronics.net

Aries Electronics

2609 Bartram Road, Bristol, PA 19007 USA; 215-781-9956; Fax: 215-781-9845; www.arieselec.com

ASR Technologies, Inc.

332 Crestview Road, Ottawa Ontario K1H 5G6 Canada; 613-737-2026; Fax: 613-737-3098; Dr. Andrew Podgorski, a.podgorski@ieee.org; www.asrtechnologiesinc.com

AT4 Wireless

C/ Severo Ochoa, 2 PTA Campanillas, Malaga 29590, Spain; +34 95 261 91 00; jcasini@at4wireless.com; www.at4wireless.com

ATLAS Compliance & Engineering

1792 Little Orchard Street, San Jose, CA 95125 USA; 408-971-9743; Fax: 408-971-9783; Atlas Sales, sales@atlasce.com; www.atlasce.com

Austest Laboratories

33-35 Alleyne St., ground floor, Chatswood, Sydney NSW 2067, Australia; +61 (0)2 9882 6500; Fax: +61 (0)2 9882 6600; martin@austest.com.au; www.austest.com.au

Autosplice, Inc.

10121 Barnes Canyon Road, San Diego, CA 92121 USA; 858-678-3181; Fax: 858-535-0130; cmiller@autosplice.com; www.autosplice.com

Avalon Test Equipment Corp.

2453 Cades Way, Suite B Vista, CA 92081 USA; 760-536-0191; Fax: 760-536-0184; Stephen McIlhon, smcilhon@avalontest.com; www.avalontestequipment.com

Averna

87 Prince St., Suite 140, Montreal Quebec, Canada H3C 2M7; 514-842-7577; Fax: 514-842-7573; www.averna.com/urt/

AVX Corporation

One AVX Boulevard, Fountain Inn, SC 29644 USA; 864-967-9375; Callie Baldwin, callie.baldwin@avx.com; www.AVX.com

AWR Corporation

1960 E. Grand Ave., Suite 430 El Segundo CA 90245 USA; 310-726-3000; Fax: 310-726-3005; Antti Lautanen, antti@awrcorp.com; www.awrcorp.com

Axonics, Inc.

20 Post Lane North, Suffern, NY 10901 USA; 845-228-8924; Marc Grun, info@axonics.net; www.axonics.net

B

Bal Seal Engineering, Inc.

19650 Pauling, Foothill Ranch, CA 92610 USA; 800-366-1006; Fax: 949-460-2300; sales@balseal.com; www.balseal.com

Barth Electronics, Inc.

1589 Foothill Drive, Boulder City, NV 89005 USA; 702-293-1576; Fax: 702-293-7024; debbie@barthelectronics.com; www.barthelectronics.com

Bay Area Compliance Labs Corp.

1274 Anvilwood Ave., Sunnyvale, CA 94089 USA; 408-732-9162, ext. 3106; Fax: 408-732-9164; www.baclcorp.com

BEC Inc.

970 East High St., Pottstown, PA 19464 USA; 610-970-6880; Fax: 610-970-8381; sales@bec-ccl.com; www.bec-ccl.com

Beehive Electronics

8555 Lawrence Lane, Sebastopol, CA 95472 USA; 707-824-9206; Fax: 707-581-1955; sales@beehive-electronics.com; www.beehive-electronics.com

Beijing Tempest Electronics Technologies Co. Ltd.

Room 321, Zhuanxiu Building No.83, Fuxing Road, Beijing, China; 010-66697852; Fax: 010-66699041; tempest@public.bta.net.cn; www.chinatpst.com

BI Technologies

4200 Bonita Place, Fullerton, CA 92835 USA; 714-447-2345; Fax: 714-447-2400; sales@bitechnologies.com; www.bitechnologies.com

Binder-USA

3903 Calle Tecate, Camarillo, CA 93012 USA; 805-437-9925; greg.harter@binder-usa.com; www.binder-usa.com

Bird Technologies Group / TX RX Systems

30303 Aurora Road, Solon, OH 44139 USA; 440-248-1200; 866-695-4569; Fax: 440-248-5426; sales@bird-technologies.com; www.bird-technologies.com

Blackwood Labs

8 Woodfieldside Business Park, Pontllanfraith, Blackwood, South Wales NP12 2DG, United Kingdom; +44 (0) 1495 229219; test@blackwood-labs.co.uk; www.blackwood-labs.co.uk

Blue Guide EMC Lab

Joseph Cardijnstraat 21, B-9420 Erpe-Mere, Belgium; +32 (0) 53 60 16 52; Fax: +32 (0) 53 70 78 99; info@bgemc.com; www.bgemc.com

Bourns Inc.

1200 Columbia Ave., Riverside, CA 92507-2129 USA; 951-781-5500; www.bourns.com

Boyd Corporation

600 So McClure Road, Modesto, CA 95357 USA; 209-236-1111; 800-554-0200; www.boydcorp.com

Braco Compliance Ltd.

P.O. Box 31188, Ilam, Christchurch, Canterbury 8444,

New Zealand; +64 21 208 4303; admin@bracompliance.com; www.bracompliance.com

Braden Shielding Systems

9260 Broken Arrow Expressway, Tulsa, OK 74145 USA; 918-624-2888, ext. 102; Fax: 918-624-2886; Glen Pierandri, Manager of Gov't. / Commercial Products, gpierandri@bradenshielding.com; www.bradenshielding.com

Brim Electronics, Inc.

120 Home Place, Lodi, NJ 07644 USA; 201-796-2886; danziba@gmail.com; www.brimelectronics.com

Bud Industries

4605 E. 355th St., Willoughby, OH 44094 USA; 440-946-3200; Fax: 440-951-4015; saleseast@budind.com; www.budind.com

Bureau Veritas (formerly Curtis-Straus)

Littleton Distribution Center, One Distribution Center Circle, Suite #1, Littleton, MA 01460 USA; 978-486-8880; 877-277-8880; Fax: 978-486-8828; craig.lazinsky@us.bureauveritas.com; www.BureauVeritas.com/EE

Bystat International Inc.

2630, rue Sabourin, Ville Saint-Laurent Québec, Canada, H4S 1M2; 514-333-8880; 800-361-6777; Fax: 514-333-8885; static@bystat.com; www.Bystat.com

C

Calbrooke Marketing Inc.

PO Box 39, Arthur ON N0G 1A0 Canada; 519-848-3810; Brooke Heiliger, brookeh@calbrooke.com; www.calbrooke.com

Calmont Wire & Cable, Inc.

420 East Alton Ave., Santa Ana, CA 92707; 714-549-0336; Fax: 714-549-4028; Gordon Dunn, calsales@calmont.com; www.calmont.com

CAP Wireless

3235 Grande Vista Drive, Newbury Park, CA 91320 USA; 805-499-1818; Fax: 805-499-6649; info@capwireless.com; www.capwireless.com

Capcon International, Inc.

120 Craft Ave., Inwood, NY 11096-1708 USA; 516-371-5600; Fax: 516-239-5481; turab@capconemi.com; www.capconemi.com

CAPLINQ Corp.

957 Snowshoe Crescent, Orléans (Ottawa) Ontario, K1C 2Y3, Canada; 613-482-2215; Fax: 702-995-1235; info@caplinq.com; www.caplinq.com

Caprock Mfg.

2303 120th St., Lubbock, TX 79423 USA; 806-745-6454; Fax: 806-745-5963; caprock@caprock-mfg.com; www.caprock-mfg.com

Captor Corp. 79

5040 South County Road 25A, Tipp City, OH 45371 USA; 937-667-8484; Fax: 937-667-5133; Scott Timms, stimms@captorcorp.com; www.CaptorCorp.com

Cascade TEK

5245-A NE Elam Young Parkway, Hillsboro, OR 97124 USA; 503-648-1818; 888-835-9250; Fax: 503-648-1798; www.cascadetek.com

Central Coating Company

165 Shrewsbury St., West Boylston, MA 01583 USA; 508-835-6225; Fax: 508-835-6228; aaccettullo@centralcoating.com; www.centralcoating.com

CertifiGroup

901 Sheldon Drive, Cary, NC 27513 USA; 800-422-1651; info@certifigroup.com; www.certifigroup.com

CETECOM Inc.

411 Dixon Landing Road, Milpitas, CA 95035 USA; 408-586-6200; sales@cetecomusa.com; www.cetecomusa.com

CGS Technologies

1801 W. Parkside Lane, Phoenix, AZ 85027 USA; 623-869-0600; Fax: 623-582-4813; info@cgstech.com; www.cgstech.com

Cherry Clough Consultants Ltd.

9 Bracken View, Brocton, Staffordshire ST17 0TF, United Kingdom; +44 (0) 1785 660 247; Fax: +44 (0) 1785 660 247; Keith.Armstrong.cherryclough@aol.com; www.cherryclough.com

Chomerics, Div. of Parker Hannifin Corp.

77 Dragon Court, Woburn, MA 01888 USA; 781-935-4850; Fax: 781-933-4318; chomailbox@parker.com; www.chomerics.com; 100 Indigo Creek Drive, Rochester, NY 14626-5101 USA; 781-939-4158; Fax: 781-935-2758; pterilli@parker.com; www.chomericstest.com

Cima NanoTech, Inc.

1000 Westgate Drive, St. Paul, MN 55114-1067 USA; 651-646-6266; Fax: 651-646-4161; egranstrom@cimananotech.com; www.cimananotech.com

Circuit Insights LLC

3744 Valley Lights Drive, Pasadena, CA 91107 USA; 626-201-0488; Fax: 626-466-4448; circuit-insights@charter.net; www.LoopSlooth.com

CITEL Inc.

1515 NW 167th St., Suite 6-303, Miami, FL 33169 USA; 305-621-0022; Fax: 305-621-0766; citel@citelprotection.com; www.citelprotection.com

CKC Laboratories, Inc.

5046 Sierra Pines Drive, Mariposa, CA 95338 USA; 209-966-5240; 800-500-4362; Fax: 866-779-9776; ckclubs@ckc.com; www.ckc.com

ClickFold Plastics

2900 Westinghouse Blvd., Ste. 118, Charlotte, NC 28273 USA; 866-649-8665, ext. 701; Fax: 866-649-8665; info@clickfold.com; www.clickfoldplastics.com

Cobham Microwave

Stocks Lane, Bracklesham Bay, Chichester, West Sussex, United Kingdom; +44 (0) 1243 670711; Fax: +44 (0) 1243 672907; www.cobham.com/microwave

Combinova AB

Domkraftsvägen 1,S-197 40, Bro, Sweden; +46-8-627 93 10; Fax: +46-8-29 59 85; sales@combinova.se; www.combinova.se

Communication Certification Laboratory

1940 W. Alexander St., Salt Lake City, UT 84119 USA; 801-972-6146; Fax: 801-972-8432; info@cclab.com; www.cclab.com

Communication Coil, Inc.

9601 Soreng Ave., Schiller Park, IL 60176 USA; 847-671-1333; Fax: 847-671-9191; info@communicationcoil.com; www.communicationcoil.com

Compac Development Corp.

1460 North Clinton Ave., Suite 0-15, Bay Shore, NY 11706 USA; 631-585-3400; Fax: 631-585-3534; prao@compac-rf.com; www.compac-rf.com

Compatible Electronics, Inc.

114 Olinda Drive, Brea, CA 92823 USA; 714-579-0500; ruby@celectronics.com; www.celectronics.com

Compliance Certification Services

47173 Benicia St., Fremont, CA 94538 USA; 510-771-1000; Fax: 510-661-0888

Compliance Engineering Ireland Ltd.

Raystown, Ratoath Road, Ashbourne, Co. Meath, Ireland; +353 1 8256722; john.mcauley@cei.ie; www.cei.ie/

Compliance Management Group

257 Simarano Drive, Marlborough, MA 01752 USA; 508-460-1400; Fax: 508-46-7979; Eric.Wilbur, info@cmgcorp.net; www.cmgcorp.net

Compliance Testing, LLC

3356 N San Marcos Place, Ste 106, Chandler, AZ 85225 USA; 480-926-3100; Fax: 480-926-3598; Michael.Schafer, michael@ComplianceTesting.com; www.ComplianceTesting.com

Compliance West, USA

650 Gateway Center Drive, Suite D, San Diego, CA 92012 USA; 619-878-9696; Fax: 619-794-0404; Jeff.Lind, jlind@compwest.com; www.compwest.com

Compliance Worldwide

357 Main Street, Sandown, NH 03873 USA; 603-998-3903; Fax: 603-887-6445; Larry.Stillings, Sales@cw-inc.com; www.complianceworldwide.com

Com-Power Corp.

114 Olinda Drive, Brea, CA 92823 USA; 714-528-8800; Fax: 714-579-1850; sales@com-power.com; www.com-power.com

Comtech PST Corp.

105 Baylis Road, Melville, NY 11757 USA; 631-777-8900; Fax: 631-777-8877; sales@comtechpst.com; www.comtechpst.com

Comtest Engineering bv

Industrieweg 12, Zoeterwoude, 2382NV Netherlands; +31 71 5417531; Fax: +31 71 5420375; J.A. Kappert, info@comtest.eu; www.comtest.eu

Conductive Compounds Inc.

17 Hampshire Drive, Unit 8, Hudson, NH 03051 USA; 603-595-6221; Fax: 603-595-6228; sales@conductivecompounds.com; www.conductivecompounds.com

CONEC Corp. - USA

343 Technology Drive #1101, Garner, NC 27529 USA; 919-460-8800; Fax: 919-460-0141; info@conec.com; www.conec.com

Connors Company

PO Box 807, Carver, MA 02330 USA; 508-272-1500; Fax: 508-866-5393; Brian.Connors, Brian@ConnorsRep.com; ConnorsRep.com

Cool Polymers, Inc.

51 Circuit Drive, North Kingstown, RI 02852 USA; 401-667-7830; Fax: 401-677-7831; Jim.Miller, sales@coolpolymers.com; www.coolpolymers.com

Core Compliance Testing Services

79 River Road, Hudson, NH 03051 USA; 603-889-5545; khcmacgrath@aol.com; www.corecompliancetesting.com

Cosmo Ferrites Limited

Solan, Himachal Pradesh, India; 911792 277231-36; www.cosmoferrites.com



CPI (Communications & Power Industries)..... 49

Satcom Div., 45 River Drive, Georgetown, ON L7G 2J4, Canada; 905-877-0161; Fax: 905-877-5327; marketing@satcom.cpuii.com; www.cpuii.com/cmp; Tom Sertic

AZ	R.A. Mayes, Eric Evans	303-761-9447
CA	Redondo Beach, C-WAVE	310-937-3521
CA	San Jose, MC Microwave, Inc.	408-446-4100
CO	R. A. Mayes, Eric Evans	303-761-9447
FL	Ft. Lauderdale, TEQSPEC, Bob Leacock	954-370-5824
MD	M. Lader Co.	610-825-3177

NJ	PVP Sales, Vince Schiel	201-841-2293
NJ	Scientific Devices, New England	508-528-2458
NM	R.A. Mayes, Eric Evans	303-761-9447
NY	PVP Sales, Vince Schiel	201-841-2293
OK	Comreps, John Casey	972-867-7003
OR	Lionheart, Leo Smale	425-882-2587
PA	M. Lader Co.	610-825-3177
TX	Comreps, John Casey	972-867-7003
UT	R.A. Mayes, Eric Evans	303-761-9447
VA	M. Lader Co.	610-825-3177

INTERNATIONAL

CHE	Zugs, CPI Switzerland	41-41-749-8522
DEU	Munich, CPI Germany	49-89-45-87370
DNK	FA Consulting	49-70-8077
FIN	Advancetec OY	358-9-3505-260
GBR	Walton-on-Thames, CPI UK	44-1932-898-080
IND	New Delhi, CPI India	91-11-614-6716
ISR	Tel Aviv, Rapac Electronics	972-3-920-3456
ITA	Torino, CPI Italy	39-11-771-4765
JPN	Tokyo	81-3-3639-9814
NLD	Oudstrijdersstraat, CPI Belgium	32-14-43-1140
NOR	Hans H. Schive	47-66-76-0513
SGP	CPI Asia, Inc.	65-6225-0011
SWE	Stockholm, Compomill	46-31-733-2150

Cranage EMC Testing Ltd.

Stable Court, Oakley, Market Drayton, Shropshire TF9 4AG, United Kingdom; +44 1630 658568; Fax: +44 1630 65821; keith.rich@cranage.co.uk; www.cranage.co.uk

Cre8 Associates Ltd.

Bruntingthorpe Proving Ground, Bath Lane, Lutterworth, Leicestershire, LE17 5QS, United Kingdom; +44 (0)1162 479787; davidh@cre8-associates.com; www.cre8-associates.com

Creative Materials, Inc.

12 Willow Road, Ayer, MA 01432 USA; 978-391-4700; Fax: 978-391-4705; Marcia.Chapman, info@creative materials.com; www.creativematerials.com

Criterion Technology, Inc.

1350 Tollard Road, P.O. Box 489, Rollinsville, CO 80474 USA; 303-258-0100; Fax: 303-258-0775; critech@earthlink.net; www.criteriontech.com

CSA International

8501 E. Pleasant Valley Road, Cleveland, OH 44131-5516, USA; 216-524-4990; Fax: 216-328-8138; Sales, cert. sales@csa-international.org; www.csa-international.org



CST of America, Inc. 105

492 Old Connecticut Path, Suite 505, Framingham, MA 01701; USA; 508-665-4400; Fax: 508-665-4401; info@cst.com; www.cst.com

CA	CST of America, Inc.	650-472-3790
INTERNATIONAL		
AUS	Oxley, RF Shop	61 7 3375 6767
BRA	CST AG	55 11 2645 6470
CHN	Shanghai, CST China Ltd.	86 21 5080 2328
	Beijing, CST China Ltd.	86 10 8248 3820
DEU	CST Computer Simulation Technology	49 6151 7303 0
FRA	CST France Eurl.	33 1 45 37 38 25
GBR	Nottingham, CST UK Ltd.	44 115 9061 120
ITA	CST AG	39 0363 3512 42
JPN	KawasakiCity, AET, Inc.	81 44 980 0505
KOR	CST of Korea, Inc.	82 31 781 6866
MYS	Computer Simulation Technology Malaysia Sdn. Bhd.	60 377 311 587
TWN	CST Taiwan	886 3 5332541
IND	CST AG	91 44 32551460
CZE	CST AG, Prague	420 257 219 488
SGP	CST South East Asia Pte. Ltd.	65 6562 8705

Curtis Industries/Filter Networks 76
2400 S. 43rd St., Milwaukee, WI 53219; 414-649-4200;
Fax: 414-649-4279; sales@curtisind.com;
www.curtisind.com; Steven Powers, Pres.; Al Hungs-
berg, Sales Director; Glenn Cummings, Regional Sales
Manager

Custom Assembly LLC

600 Wheat Lane, Wood Dale, IL 60191 USA; 630-595-
4855; 800-323-9562; Fax: 630-595-1666; mschuck@
phoenixofchicago.com; www.customassemblyllc.com

Cybershield

308 Ellen Trout Drive, Lufkin, TX 75904 USA; 936-633-
6387; Fax: 936-633-6398; www.cybershieldinc.com

D

D.A.R.E!! Calibrations

Vijzelmolenlaan 7, Woerden, Utrecht NL-3447 GX, the
Netherlands; +31 (0)348 431 807; Fax: +31 (0)348 421
198; www.calibrations.dare.eu

D.A.R.E!! Consultancy

Vijzelmolenlaan 7, Woerden, Utrecht NL-3447GX, The
Netherlands; +31 348 430 979; Fax: +31 348 430 645;
René Dijkstra, consultancy@dare.nl; consultancy.dare.nl

D.A.R.E!! Instruments

Vijzelmolenlaan 7, Woerden, Utrecht NL-3447 GX, The
Netherlands; +31 348 416 592; Fax: +31 348 499 732;
Edwin vom Hofe, instruments@dare.nl;
instruments.dare.eu



**EMC & Product Safety
Testing • Consulting**

D.L.S. Electronic Systems, Inc.

1250 Peterson Dr., Wheeling, IL 60090; 847-537-6400;
Fax 847-537-6488; jblack@dlsemc.com;
www.dlsemc.com

Datatronics

28151 Highway 74, Romoland, CA; 951-928-7700;
Fax: 951-928-7701; www.datatronics.com

Dayton T. Brown, Inc.

1175 Church St., Bohemia, NY 11716-5031 USA; 631-
589-6300; Fax: 631-589-3648; test@dtbtest.com;
www.dtbtest.com

dB Control

1120 Auburn St., Fremont, CA 94538 USA; 510-656-
2325; Fax: 510-656-3214; solson@dbcontrol.com;
www.dBControl.com

dB Corp.

216 Hillsboro Ave., Lexington, KY 40511 USA; 859-253-
1178; Fax: 859-252-6128; www.dbcorporation.com

Delta Products Corp.

4405 Cushing Parkway, Fremont, CA; 919-767-3860;
www.deltavv.com

Desco Industries Inc.

3651 Walnut Ave., Chino, CA 91710 USA; 909-627-8178;
Fax: 909-627-7449; www.DescoIndustries.com

Device Technologies, Inc.

155 Northboro Road, Unit 8, Southborough, MA 01772
USA; 508-229-2000; Fax: 508-229-2622; Nick Petri,
Director of Sales & Marketing, npetri@devicetech.com;
www.devicetech.com/shielding/default.asp

Dexmet Corp.

22 Barnes Industrial Road South, Wallingford, CT 06492
USA; 203-294-4440; Fax: 203-294-7899;
sales@dexmet.com; www.dexmet.com

Dexter Magnetic Technologies

1050 Morse Ave., Elk Grove Village, IL 60007 USA;
847-956-1140; 800-775-3829; Fax: 877-221-5052; info@
dexterimg.com; www.dexterimg.com/soft-magnetics.
asp

Diversified T.E.S.T. Technologies

4675 Burr Drive, Liverpool, NY 13088 USA; 315-457-
0245; Fax: 315-457-0428; annelle@dttlab.com;
www.dttlab.com



DNB Engineering, Inc.

3535 W. Commonwealth Ave., Fullerton, CA 92833 USA;
800-282-1462; 714-870-7781; Fax: 714-870-5081; Tony
Piraino, tonyp@dnbenginc.com; www.dnbenginc.com
CA Riverside, Tony Piraino, Sls & Mktg Manager 951-637-2630
UT Coalville, Les Payne Manager 435-336-4433

Don HEIRMAN Consultants

143 Jumping Brook Road, Lincroft, NJ 07738 USA;
732-741-7723; Fax: 732-530-5695; Don Heirman,
d.heirman@ieee.org; www.DonHeirman.com



Dontech Inc.

700 Airport Blvd., Doylestown, PA 18902; 215-348-5010;
Fax: 215-348-9959; Jeff Blake, jblake@dontech.com;
www.dontech.com

Dynamic Sciences International, Inc.

6130 Variel Av., Woodland Hills, CA 91367 USA; 818-
226-6262; 800-966-3713; Fax: 818-226-6247; market@
dynamicssciences.com; www.dynamicssciences.com

E

E3 Displays

21050 N. 9th Place, Suite 309, Phoenix, AZ 85024 USA;
602-288-9758; Fax: 602-288-9762; Dennis Rahrig,
dennsr@e3displays.com; www.e3displays.com

E&C Anechoic Chambers Asia Ltd.

Flat/Rm 303, 3/F St. George's Bldg, 2 Ice House St.,
Central Hong Kong; +852 397 221 73; Fax: +852 397 222
11; jtsang@ecanechoicchambers.com;
www.ecanechoicchambers.com

E.F. Electronics Co.

217 W. Mill St., Montgomery, IL 60538 USA; 630-897-
1950; EFEMCTEST@aol.com

East Coast Shielding

1914 Rt 57, Hackettstown, NJ 07840 USA; 908-227-
6857; Fax: 908-852-9163; mike@eastcoastshielding.
com; www.eastcoastshielding.com

Ecliptek Corp.

3545-B Cadillac Ave., Costa Mesa, CA; 714-433-1200;
Fax: 714-433-1234; customersupport@ecliptek.com;
www.ecliptek.com

Ed Fagan Inc.

769 Susquehanna Ave., Franklin Lakes, NJ 07417 USA;
201-891-4003; 800-348-6268; Fax: 201-891-3207;
sales@edfagan.com; www.edfagan.com

EEMCCOIMEX

Apolloweg 80, Lelystad Flevoland 8239 DA Netherlands;
31320295395; Fax: 31320413133; A.J.J. Naus, anaus@
eemc.nl; www.eemccoimex.nl

Eeonyx Corp.

750 Belmont Way, Pinole, CA 94564 USA; 510-741-3632;
Fax: 510-741-3657; info@eeonyx.com; www.eeonyx.com

EESeal

5639 B Jefferson NE, Albuquerque, NM 87109 USA;
505-243-1423; Fax: 505-243-9772; eeseal@aol.com;
www.eeseal.com

E-Labs Inc.

4007 Leonard Drive, Fredericksburg, VA 22408 USA;
540-834-0372; Fax: 540-834-0373; info@e-labsinc.com;
www.e-labsinc.com

Electri-Flex Company

222 W. Central Ave., Roselle, IL 60172 USA; 800-323-
6174; 630-529-0482; Janelle Blazejewski, mktg@
electriflex.com; www.electriflex.com

Electrocube, Inc.

3366 Pomona Blvd., Pomona, CA 91768 USA; 909-595-
4037; 800-515-1112; Fax: 909-595-0186;
esales@electrocube.com; www.electrocube.com

ElectroMagnetic Investigations, LLC

20811 NW Cornell Road, Suite 600, Hillsboro, OR 97124
USA; 503-466-1160; 888-466-1160; Fax: 503-466-1170;
support@emicomply.com; www.emicomply.com

Electro Magnetic Test, Inc.

1547 Plymouth St., Mountain View CA 94043 USA; 650-
965-4000; Fax: 650-965-3000; Jay Gandhi, jgandhi@
emtlabs.com; www.emtlabs.com

Electro-Metrics Corp.

231 Enterprise Road, Johnstown, NY 12095 USA;
518-762-2600; Fax: 518-762-2812; Valerie Zabo, vzabo@
emihq.com; www.electro-metrics.com

Electro Rent Corporation

6060 Sepulveda Blvd., Van Nuys, CA 91411 USA;
(800) 688-1111; (818) 786-4354; Herb Ostenberg, sales@
electrorent.com; www.ElectroRent.com

Electronic Instrument Associates

P.O. Box 6487, Bloomington, IL 61018-6487 USA; 630-
924-1600; Fax: 630-477-0321; frank@electronicinstru-
ment.com; www.electronicinstrument.com



Electronics Test Centre (Kanata)

302 Legget Drive, Suite 100, Kanata K2K 1Y5, Canada;
613-599-6800; Fax: 613-599-7614; Lynn Diggins, lynn.
diggins@etc-mpb.com; 27 East Lake Hill, Airdrie, Alberta
T4A 2K3, Canada; 403-912-0037; Fax: 403-912-0083;
Mala Mediboina, mmediboina@etc-mpbtech.com;
www.etc-mpb.com

Electrorack Enclosure Products

1443 South Sunkist St., Anaheim, CA; 714-776-5420;
Fax: 714-776-9683; www.electrorack.com



Elite Electronic Engineering Inc.

1516 Centre Circle, Downers Grove, IL 60515-1082;
800-ELITE-11, 630-495-9770, ext. 119; Fax: 630-495-
9785; sglaya@elitetest.com; www.elitetest.com

Elite EMC Ltd.

12 Station Road, Marston Green, Birmingham, West Midlands B37 7AS, United Kingdom; +44 121 288 0543; Fax: +44 121 288 0543; David Hobbs, sales@eliteemc.com; www.eliteemc.com



EM Software & Systems-SA (Pty) Ltd. 107

P.O. Box 1354, Stellenbosch, 7599, South Africa; +27 (0)21 880 1880; Fax: +27 (0)21 880 1936; Celeste Mockey, info@emss.co.za; www.feko.info
 VA Hampton, EM Software & Systems (USA) Inc..... 866-419-FEKO, www.emssusa.com

INTERNATIONAL

CHN Shanghai, EM Software & Systems China +021-50116635, www.emss-china.net
 DEU Böblingen, EM Software & Systems GmbH +49 (0)7031 714 5200, www.emss.de



EM Test USA..... 3

3 Northern Blvd., Unit A-4, Amherst, NH 03031 USA; 603-769-3477; Fax: 603-769-3499; Michael Hopkins, m.hopkins@emtest.com; www.emtest.com

Embassy Global, LLC

PO Box 105, Orchard Park, NY 14127-0105 USA; 800-309-6150; Fax: 716-706-1248; info@embassyglobalpr.com; www.embassyglobalpr.com

EMC Compliance

P.O. Box 14161, Huntsville, AL 35815-0161 USA; 256-650-5261; Ken Javor, ken.javor@emccompliance.com; www.emccompliance.com

EMC Component Group, Inc.

2901 Tasman Drive, Suite 211, Santa Clara, CA 95054 USA; 408-330-9216; Fax: 408-330-0012; sales@emccomponent.com; www.emccomponent.com

EMCCons Dr. Rasek GmbH

Moggast, Boelwiese 4-8, 91320 Ebermannstadt, Germany; +49-9194-9016; Fax: +49-9194-8125; i.helldoerfer@emcc.de; www.emcc.de

EMC Engineering and Safety

Haifa, Israel; 972-528396080

EMC Eupen, A Div. of I2R Corp.

5033 Industrial Road, Bldg. 6, Farmingdale, NJ 07727 USA; 732-919-1100; Fax: 732-919-7196; sales@emceupen.com; www.emceupen.com

EMC Goggles Ltd.

P.O. Box 130, Cwmbran, Torfaen NP44 9BT, United Kingdom; +44 (0) 7506015791; John Davies, info@emcgoggles.com; www.emcgoggles.com

EMC Integrity, Inc.

1736 Vista View Drive, Longmont CO 80504 USA; 888-423-6275; Fax: (303) 776-7314; Vincent Greb, info@emcintegrity.com; www.emcintegrity.com

EMC Management Concepts

46603 Kingschase Court, Sterling, VA; 703-864-7023; Fax: 801-849-3516; bfarmer@emcmanagement.com; www.emcmanagement.com

EMC Partner AG 39

Baselstrasse 160, Laufen 4242, Switzerland; +41 61 775 2030; Fax: +41 61 775 2059; Nicholas Wright, sales@emc-partner.ch; www.emc-partner.com

INTERNATIONAL

AU Sydney, Test & Measurement.....+61 2 4739 9523
 AR Buenos Aires, Mannos+54 11 4373 25 85
 BE Berchem-Ste-Agathe, Decatel+32 2 469 00 90
 BR Sao Paulo, Test & Measurement.....+55 11 5092 5229
 CA Manassas, HV Technologies+1 703 365 2330

CN	Shanghai, Precision International	+86 21 6211 5111
CZ	Prague, Tectra.....	+420 281 921 650
DE	Iserlohn, H+H	+49 2371 7853-0
EG	Ramadan City, Horus	+20 15 379416
ES	Barcelona, Wavecontrol	+34 933 20 80 55
FI	Helsinki, INEL	+358 10 423 7570
FR	Cosnac, EMC Partner.....	+33 5 55 74 31 68
GB	High Wycombe, EMC Partner	+44 1494 44 42 55
GR	Athens, ACTA.....	+30 210 600 33 02
HU	Budapest, EL Test.....	+36 1 202 18 73
IL	Petach Tikva, Dan-El.....	+97 2 3 927 1888
IT	Milan, AFJ Instruments.....	+39 02 91 43 48 50
JP	Tokyo, Nippon Automatic Control	+81 3 5434 1600
KR	Seoul, Kwang Wha Trading	+82 2 2679 39 96
MX	Manassas, HV Technologies	+1 703 365 2330
NL	Oosterleek, Rimarck.....	+31 229 503 478
PL	Poznan, ASTAT.....	+48 61 849 80 61
SE	Vellinge, ERDE.....	+46 40 42 46 10
SG	Singapore, Precision Tech.....	+65 6273 4573
TR	Istanbul, Aktif Nesor	+90 216 577 6999
TW	Taipei, Precision International.....	+886 2 8512 4888
US	Manassas, HV Technologies	+1 703 365 2330
ZA	Sandton, Protea Electronics.....	+27 11 719 57 00

EMC Technologies Pty Ltd.

176 Harrick Road, Keilor Park Victoria 3042 Australia; 61393651000; Fax: 61393317455; Chris Zombolas, chris@emctech.com.au ; www.emctech.com.au

EMC Tempest Engineering

2190 East Winston Road, Anaheim, CA 92806 USA; 714-778-1726; www.emctempest.com

EMC Test Design

PO Box 600532, Newton, MA; 508-292-1833; exid@emctd.com; www.emctd.com

EMC Testing Laboratories, Inc.

2100 Brandon Trail, Suite 101, Alpharetta, GA 30004 USA; 770-475-8819; Fax: 770-475-2011; Gene Bailey, gbailey@emctesting.com; emctesting.com

EMCC Dr. Rasek

Moggast, Boelwiese 8, Ebermannstadt 91320 Germany; +1 49 9194-9016; Fax: +1 49 9194-8125; Irmhild Helldoerfer, emc.cons@emcc.de; www.emcc.de

EMCMCC

Sedanlaan 13a, Eindhoven N.Br. 5627MS the Netherlands; +31-6-53811267; Fax: +31-40-2927481; Mart Coenen, mart.coenen@emcmcc.nl; www.emcmcc.nl

EMCO Elektronik GmbH

Bunsenstrasse 582152, Planegg, Germany; +49-89-8955650; Fax: +49-89-895 90 376; www.emco-elektronik.de

Emerson & Cuming Microwave Products, Inc.

28 York Ave., Randolph, MA 02368 USA; 781-961-9600; 800-650-5740; Fax: 781-961-2845; sales@eccosorb.com; www.eccosorb.com

EMF Testing USA

11236 Harrington St., Fishers, IN 46038-3208 USA; 800-862-9655; sbagley@indoorairste.com; www.EMFTESTING.net

EMField

Rua Nicarágua 962, salas 12/13, CEP 82510-170, Bacacheri, Curitiba, PR, Brazil; +55 (0)41 - 3044 0197; Fax: +55 (0)41 - 3044 0197; www.emfield.com.br

EMI Filter Company..... 75

12750 59th Way, North Clearwater, FL 33760 USA; 727-585-7990; 800-323-7990; Fax: 727-586-5138; sales@emifiltercompany.com; www.emifiltercompany.com

EMI Solutions Inc.

15 Hammond, Suite 304, Irvine, CA 92618 USA; 949-206-9960; Fax: 949-206-9983; bob@4emi.com; www.4emi.com

EMI Technologies, Inc.

2200 N. Telshor Blvd, Las Cruces, NM 88011 USA; 575-532-9190; Fax: 575-532-0884; Joe Alvarez, joea@emitechnologies.com; www.emitechnologies.com

Emission Control, Ltd.

12704 W. Arden Place, Butler, WI ; 262-790-0092; Fax: 262-790-0095; sales@emissioncontrol.com; www.emissioncontrol.com

EMITECH

Rue des Coudriers, ZA de l'Observatoire, Montigny le BX, Ile de France 78180, France; +33 1 30 57 55 55; Fax: 33 1 30 43 74 48; jm.rogi@emitech.fr; www.emitech.fr

EMITEMC

Arroyo de la China 3510 Rio Negro, Bariloche, Argentina; +542944527498; Hernan Sineiro, hsineiro@emitemc.com

EMP-tronic

Box 13060, Helsingborg 25013 Sverige; 46708235200; Fax: 46708235200; Lars Günther, lars@emp-tronic.se; www.emp-tronic.se

EMS-PLUS

PO Box 1265, Four Oaks, NC 27524 USA; sales@ems-plus.com; www.ems-plus.com

EMSCAN

#1, 1715 - 27 Ave. N.E., Calgary AB T2E 7E1 Canada; 403-291-0313; Fax: 403-250-8786; Erkan Ickam, info@emscan.com; www.emscan.com

emscreen GmbH

Wallbergstraße 7, Taufkirchen, Bavaria 82024, Germany; +49 89 614171-0; Fax: +49 89 61471-71; info@emscreen.de; www.emscreen.de

EMSS Consulting Pty (Ltd.)

32 Techno Ave., Technopark, Stellenbosch, Western Cape 7600, South Africa; +27 21 880 1880; bbosch@emss.co.za; www.emssixus.com

emv - Elektronische Meßgeräte Vertriebs GmbH

Wallbergstraße 7, Taufkirchen, 82024, Germany; +49 (0) 89614243; Fax: +49 (0) 89614282; awahrman@emvgmbh.de; www.emvgmbh.de

Enerdoor Inc.

75 Industrial Way, Portland, ME 04103 USA; 207-210-6511; 877-778-2875; Fax: 207-210-6512; stefano.medved@enerdoor.com; www.enerdoor.com

Engineered Testing Systems

1711 West 15th St., Indianapolis, IN 46202 USA; 317-396-0573; Fax: 317-536-8006; golten@engineered-testing.com; www.engineered-testing.com

Environ Laboratories, LLC

9725 Girard Ave., South Minneapolis, MN 55431 USA; 952-567-2302; 800-826-3710; www.environlab.com

EPCOS, Inc.

186 Wood Ave. S, Iselin, NJ 08830 USA; 732-906-4374; Fax: 732-632-5927; inductors-emc.usa@epcos.com; www.epcos.com/emc

Equipment Reliability Institute

1520 Santa Rosa Ave., Santa Barbara, CA 93109 USA; 805-564-1260; tustin@equipment-reliability.com; www.equipment-reliability.com

ERA Technology Ltd. Trading as Cobham Technical Services

Leatherhead, Surrey, United Kingdom; +44 (0) 1372 367030; www.cobham.com/technicalservices

Ergonomics, Inc.

324 Second Street Pike, Unit 3, Southampton, PA 18966 USA; 215-357-5124; Fax: 215-364-7582; DKGeorge@ergonomicsusa.com; www.ErgonomicsUSA.com



Absorber, Antennas, Chambers, Current Probes,
GTEM Cells, Probes, RF Shielding, Shielded-
Doors, Towers, Turntables, Test Accessories and More
e-mail: info@ets-lindgren.com
www.ets-lindgren.com

ETS-Lindgren 13, Back Cover

1301 Arrow Point Drive, Cedar Park, TX 78613 USA; 512-531-6400; Fax: 512-531-6500; info@ets-lindgren.com; www.ets-lindgren.com

CA	Altamont Technical Services.....	925-294-9774
GA	dBm Marketing.....	678-690-5258
IN	Electronic Instrument Associates.....	317-770-3689
MA	Intersell.....	603-465-7500
MD	EMC Technologists.....	301-668-7002
MI	Delta Technology Solutions, LLC.....	740-881-3883
MO	KJS Marketing, Inc.....	314-469-4544
NY	GSC Representatives.....	585-385-1170
TX	CF Scientific Systems.....	817-467-0970
WA	Syntek.....	503-871-9590

INTERNATIONAL

ARG	Precision Electronica SRL.....	+54 11 4735 8814,+54 11 4708-9384
ARG	Vimelec S.A.....	+54 11 4912 3998
AUS	Faraday Pty Ltd.....	+61 0 3 9729 5000
AUT	MEM.....	+43 1 943 4254
AUT	Universal Elektronik-Import GmbH.....	+43 1545 1588
BOL	CONATEL.....	+598 2902 0314
BGR	Giga Electronics.....	+359 2 731 498
BGR	Martec Ltd.....	+359 898 418 900
BRA	AK Telemedia.....	55-11-38150594
CAN	Interfax Systems, Inc.....	416-674-8970 x121
CHE	Emitec AG.....	+41 41 7486010
CHL	Dymeq Ltda.....	+56 2 3392000
CHL	Sistemas de Instrumentacion Ltda.....	+52 0 2 696 0031
COL	High Tec Environmental Ltda.....	+57 1 671 3700
COL	Technical Marketing Specialists.....	303 488-0220, ext. 303
CZE	Testovaci Technika s.r.o.....	+420 274 782 237
DEU	EMCO Elektronik GmbH.....	+49 89 895 569-23
DEU	Pischzan Technologies.....	+49 6109 771948
DNK	Metric A/S.....	+45 43 71 64 44
ECU	Caprotecsa.....	+593 59342231875
EGY	Omega Integrated Systems.....	+20 2 3370501
ESP	ALAVA Ingenieros, S.A.....	+34915679720
ESP	Nusim SA.....	+1 3491 535 9640
EST	Arpen Elekter.....	+372 671 1947
FRA	M2S Sarl.....	+33 4 6881 4952
GRC	Netscope Solutins S.A.....	+30 210 27 24 207
HKG	Euro Tech (Far East) LTD.....	+852 2 814 0311
HKG	MaxTech Instruments Limited.....	+852 27 933591
HKG	PTC International, LTD.....	+852 2 827 9977
HUN	ProMet Merestechnika Kft.....	+36 24 521 240
IND	Complus Systems Pvt. Ltd.....	+91 80 23146683
INA	PT Berca Hardayaperkasa.....	+62 21 3800902
ISR	R.D.T. Equipment & Systems Ltd.....	+972 36450745
ISR	Safe-Tech Ltd.....	+972 4 958 5789
ITA	ASEA SISTEMI S.R.L.....	+39 011 9963071
KOR	Crezon Corporation.....	82 31 777 8949
KOR	Will Technology Co Ltd.....	82 31 3226100
KSA	AMICO (medical only).....	+0119 662 660 1149
Latin America	Lumur International, Inc.....	+1 787 781-9833
LAT	Moduls Riga.....	+371 7070101
LIB	Computer Information Systems.....	+961 4 410410
LTU	Satela UAB.....	+370 699 90743
MEX	Sistemas e Ingenieria de EMC (SI-EMC).....	+52 55 2163 2148
NED	ar Benelux B.V.....	+31 172 423000
NZL	Vicom (NZ) Ltd.....	+64 9 379 4596
NOR	Nortelco Electronics AS.....	+47 22 57 6100
PAK	Telec Electronics & Machinery PVT Ltd.....	+92 21 5217201
PAR	CONATEL.....	+598 2902 0314
PER	Instrumentos y Complementos S.A.C.....	+51 1 2604 926
PHL	Ark One Solutions Inc.....	+63-2-8429090 or 91
POL	Urządzenia Elektroniczne Import (UIE).....	+48 22 313 1735
RSA	Protea Electronics (PTY) Ltd.....	+27 11 719 5700
RSA	Envirocon Instrumentation.....	+27 11 476 7323
RSA	H.A.S.S. Industrial Pty. Ltd.....	011 966 2660 1149
RUS	Sernia, Ltd.....	+7 495 225 40 14
RUS	SWEMEL Innovation Enterprise.....	+7495 154-5181
SWE	Ce-Bit Elektronik AB.....	+46 87 35 75-50
SWE	Proxitron AB.....	+1 46 141 580 00
THA	Comfort International Co., LTD.....	+66 02 391 7078

THA	iRC Technologies Limited.....	66 2717 1400, ext. 2000
TUR	Spark Measurement Technologies.....	+90 312 466 8212
TWN	Lintek Corporation.....	+886 2 2709 0387
TWN	Burgeon Instrument Co, Ltd.....	+886 3 328 0531 (15 L)
UKR	Unitest Ltd.....	+380 44 272 6094
UAE	Al-Hayat Pharmaceuticals.....	+971 +011-6-559-2481
UAE	Electrocom.....	+971 4 295 7056
UAE	Tamra Electrocom.....	+971 4 2233 259
URU	CONATEL.....	+598 2902 0314
VEN	Optipro.....	58 212 257 4434
VIE	Victory Co, LTD.....	+84 4 9761586



Absorber, Antennas, Chambers, Current Probes,
GTEM Cells, Probes, RF Shielding, Shielded-
Doors, Towers, Turntables, Test Accessories and More
e-mail: info@ets-lindgren.com
www.ets-lindgren.com

ETS-Lindgren (Lindgren RF Enclosures, Inc.)

400 High Grove Blvd., Glendale Heights, IL 60139; 630-307-7200; Fax 630-307-7571; info@lindgrenrf.com; www.ets-lindgren.com

CA	Altamont Technical Services.....	925-294-9774
GA	dBm Marketing.....	678-690-5258
IN	Electronic Instrument Associates.....	317-770-3689
MA	Intersell.....	603-465-7500
MD	EMC Technologists.....	301-668-7002
MI	Delta Technology Solutions, LLC.....	740-881-3883
MO	KJS Marketing, Inc.....	314-469-4544
NY	GSC Representatives.....	585-385-1170
TX	CF Scientific Systems.....	817-467-0970
WA	Syntek.....	503-871-9590

INTERNATIONAL

ARG	Precision Electronica SRL.....	+54 11 4735 8814,+54 11 4708-9384
ARG	Vimelec S.A.....	+54 11 4912 3998
AUS	Faraday Pty Ltd.....	+61 0 3 9729 5000
AUT	MEM.....	+43 1 943 4254
AUT	Universal Elektronik-Import GmbH.....	+43 1545 1588
BOL	CONATEL.....	+598 2902 0314
BGR	Giga Electronics.....	+359 2 731 498
BGR	Martec Ltd.....	+359 898 418 900
BRA	AK Telemedia.....	55-11-38150594
CAN	Interfax Systems, Inc.....	416-674-8970 x121
CHE	Emitec AG.....	+41 41 7486010
CHL	Dymeq Ltda.....	+56 2 3392000
CHL	Sistemas de Instrumentacion Ltda.....	+52 0 2 696 0031
COL	High Tec Environmental Ltda.....	+57 1 671 3700
COL	Technical Marketing Specialists.....	303 488-0220, ext. 303
CZE	Testovaci Technika s.r.o.....	+420 274 782 237
DEU	EMCO Elektronik GmbH.....	+49 89 895 569-23
DEU	Pischzan Technologies.....	+49 6109 771948
DNK	Metric A/S.....	+45 43 71 64 44
ECU	Caprotecsa.....	+593 59342231875
EGY	Omega Integrated Systems.....	+20 2 3370501
ESP	ALAVA Ingenieros, S.A.....	+34915679720
ESP	Nusim SA.....	+1 3491 535 9640
EST	Arpen Elekter.....	+372 671 1947
FRA	M2S Sarl.....	+33 4 6881 4952
GRC	Netscope Solutins S.A.....	+30 210 27 24 207
HKG	Euro Tech (Far East) LTD.....	+852 2 814 0311
HKG	MaxTech Instruments Limited.....	+852 27 933591
HKG	PTC International, LTD.....	+852 2 827 9977
HUN	ProMet Merestechnika Kft.....	+36 24 521 240
IND	Complus Systems Pvt. Ltd.....	+91 80 23146683
INA	PT Berca Hardayaperkasa.....	+62 21 3800902
ISR	R.D.T. Equipment & Systems Ltd.....	+972 36450745
ISR	Safe-Tech Ltd.....	+972 4 958 5789
ITA	ASEA SISTEMI S.R.L.....	+39 011 9963071
KOR	Crezon Corporation.....	82 31 777 8949
KOR	Will Technology Co Ltd.....	82 31 3226100
KSA	AMICO (medical only).....	+0119 662 660 1149
Latin America	Lumur International, Inc.....	+1 787 781-9833
LAT	Moduls Riga.....	+371 7070101
LIB	Computer Information Systems.....	+961 4 410410
LTU	Satela UAB.....	+370 699 90743
MEX	Sistemas e Ingenieria de EMC (SI-EMC).....	+52 55 2163 2148
NED	ar Benelux B.V.....	+31 172 423000
NZL	Vicom (NZ) Ltd.....	+64 9 379 4596
NOR	Nortelco Electronics AS.....	+47 22 57 6100
PAK	Telec Electronics & Machinery PVT Ltd.....	+92 21 5217201
PAR	CONATEL.....	+598 2902 0314

PER	Instrumentos y Complementos S.A.C.....	+51 1 2604 926
PHL	Ark One Solutions Inc.....	+63-2-8429090 or 91
POL	Urządzenia Elektroniczne Import (UIE).....	+48 22 313 1735
RSA	Protea Electronics (PTY) Ltd.....	+27 11 719 5700
RSA	Envirocon Instrumentation.....	+27 11 476 7323
RSA	H.A.S.S. Industrial Pty. Ltd.....	011 966 2660 1149
RUS	Sernia, Ltd.....	+7 495 225 40 14
RUS	SWEMEL Innovation Enterprise.....	+7495 154-5181
SWE	Ce-Bit Elektronik AB.....	+46 87 35 75-50
SWE	Proxitron AB.....	+1 46 141 580 00
THA	Comfort International Co., LTD.....	+66 02 391 7078
THA	iRC Technologies Limited.....	66 2717 1400, ext. 2000
TUR	Spark Measurement Technologies.....	+90 312 466 8212
TWN	Lintek Corporation.....	+886 2 2709 0387
TWN	Burgeon Instrument Co, Ltd.....	+886 3 328 0531 (15 L)
UKR	Unitest Ltd.....	+380 44 272 6094
UAE	Al-Hayat Pharmaceuticals.....	+971 +011-6-559-2481
UAE	Electrocom.....	+971 4 295 7056
UAE	Tamra Electrocom.....	+971 4 2233 259
URU	CONATEL.....	+598 2902 0314
VEN	Optipro.....	58 212 257 4434
VIE	Victory Co, LTD.....	+84 4 9761586

EU Compliance Services, Inc.

7580 St. Clair Ave., Mentor, OH 44060 USA; 440-918-1425; Fax: 440-918-1476; emcjanki@aol.com; www.eucs.com

Euro EMC Service (EES)

Dr. D.Hansen Bahnhofstr. 39 POB 84 Berikon AG CH-8965 Diethardland; +41 566 33 73 81; Fax: +41 566 33 73 81; Dr. Diethard Hansen, euro.emc.service@swissonline.ch; www.euro-emc-service.de

Eurofins Product Service GmbH

Storkower Str. 38C Reichenwalde 15526 Germany; +49 33631 8880; Fax: +49 33631 888 660; jenszimmermann@eurofins.com; http://pt.eurofins.com

F

F-Squared Laboratories

26501 Ridge Road, Damascus, MD 20872 USA; 301-253-4500; 877-405-1580; Fax: 301-253-5179; Ken DeVore, kdevore@f2labs.com; www.f2labs.com

Fabreeka International, Inc.

1023 Turnpike St., P.O. Box 210, Stoughton, MA 02072 USA; 781-341-3655; Fax: 781-341-3983; info@fabreeka.com; www.fabreeka.com

Fabritech, Inc.

20 Hagerty Blvd., Suite 2, West Chester, PA 19382 USA; 570-702-4527; Fax: 610-431-7925; Randall Drew, fabritechfieldsales@hotmail.com; www.fabritechinc.net/index.htm



Fair-Rite Products Corp. 66

1 Commercial Row, P. O. Box 288, Walkill NY, 12589; 845-895-2055; Fax 845-895-2629; ferrites@fair-rite.com; www.fair-rite.com; James Montgomery, Applications Engineer; Paul Zdanowicz, Dir. Sales and Marketing; Jerry Barbara, Area Sales Manager (Western US/Mexico); Bob Polhamus, Area Sales Manager (Eastern U.S./Canada)

AL	Huntsville, Millennium Sls.....	256-461-8655
AZ	Phoenix, Arcadia Tech. Sls.....	480-956-8144
CA	Anaheim, MFS Marketing Corp.....	714-991-7444
CA	Livermore, Altamont Tech Services.....	925-294-9774
CO	Littleton, Chinook Tech. Sls.....	303-933-9007
FL	Casselberry, CBX Electronics, Inc.....	407-774-9100
IL	Winfield, Charles D. Atwater Associates.....	630-668-2303
MA	West Newbury, FairRep Inc.....	978-363-5121
MI	Grand Rapids, Urban Associates Inc.....	616-361-7600
MN	Eagan, Holmes Associates, Inc.....	651-686-5354
NJ	Upperco, Imagtron Sales, Inc.....	800-638-3592
OH	Cincinnati, StaffCo-Campisano.....	513-574-7111
TX	Keller, DeWitt Manufacturers Rep.....	817-498-4755
VA	Roanoke, A.B. Kreger Co.....	540-989-4780

WA	Bothell, Temco Northwest Inc.	425-481-6150
	INTERNATIONAL	
CAN	Ontario, Pipe-Thompson Tech, Inc.	905-607-1850
CAN	British Columbia, Temco Northwest Inc.	425-481-6150
MEX	Jalisco, Ciber Electronica.....	52 33 3121-3331
	Authorized Domestic Distributors	
CA	Anaheim, Lodestone Pacific	800-694-8089
CA	Costa Mesa, Amidon Inductive Comp.	800-898-1883
IL	Elk Grove Village, Dexter Mag. Tech.	800-775-3829
IL	Chicago, Newark Inone.....	800-263-9275
NY	Melville, Arrow Electronics	800-833-3557
NY	Saugerties, Elna Magnetics	800-553-2870
NJ	E.Brunswick, Brothers Electronics.....	800-552-2255
TX	Mansfield, Mouser Electronics	800-346-6873
VA	Roanoke, Kreger Components	800-609-8186



Federal-Mogul Systems Protection..... 85
 44064 Plymouth Oaks Blvd., Plymouth, MI 48170 USA;
 610-363-2600; 800-926-2472; Fax: 610-363-9660;
 systems.protection@federalmogul.com;
 www.federalmogul.com/sp

	INTERNATIONAL	
BRA	Sao Paulo	55 11 4070 6270
CHN	Shanghai	86 21 6182 7688
FRA	Crepy-en-Valois	33 3 44 39 06 06
IND	Gurgaon.....	91 12 4478 4554
ITA	Turino.....	39 011 22 63 016
JPN	Yokohama	81 45 479 0201
	Nagoya.....	81 52 744 5501
KOR	Seoul.....	82 2 589 4551
MEX	Tepotzotlan.....	52 555 100 1338
SPA	Barcelona.....	34 93 460 24 70
THA	Ayutthaya	66 35 226 060

Ferronics, Inc.

45 O'Connor Road, Fairport, NY 14450; 585-388-1020;
 Fax: 585-388-0036; odavies@ferronics.com;
 www.ferronics.com

Feuerherdt GmbH

Motzener Str. 26b, Berlin 12277 Germany;
 +49307109645-50; Fax: +49307109645-99; Judith
 Feuerherdt, info@feuerherdt.de; www.feuerherdt.de

FIBOX Enclosures

810 Cromwell Park Drive, Suite R, Glen Burnie, MD
 21061; 410-760-9696; Fax: 410-760-8686; sales@
 fiboxusa.com; www.fiboxusa.com

Field Management Services

123 N. Laurel Ave., Los Angeles, CA 90048 USA; 323-
 937-1562, ext. 7; Fax: 323-934-2101; james.tidwell@
 fms-corp.com; www.fms-corp.com

Fil-coil

77-18 Windsor Place, Central Islip, NY 11766 USA; 631-
 467-5328; Fax: 631-467-5066; sales@custompower
 systems.us; www.CustomPowerSystem.com

Filter Concepts Inc.

2624 Rousselle St., Santa Ana, CA 92707 USA; 714-
 545-7003; Fax: 714-545-4607; John Erwin, info@
 filterconcepts.com; www.filterconcepts.com

Filtronica, Inc.

607 Brazos St., Suite U, Ramona, CA 92065 USA;
 760-788-4975; 1-888-FILTRONICA; Fax: 760-788-4356;
 peter@filtronica.com; www.filtronica.com

Fischer Connectors Inc. 41

1735 Founders Parkway, Suite 100, Alpharetta, GA
 30009 USA; 678-393-5400; mail@fischerconnectors.
 com; www.fischerconnectors.com



Fischer Custom Communications

20603 Earl St., Torrance, CA 90503 USA; 310-303-3300;
 Fax: 310-371-6268; sales@fischercc.com;
 www.fischercc.com

INTERNATIONAL

DEU	Taufkirchen, emv GmbH	49-89-614-1710
FRA	emv, s.a.r.l. (FRANCE).....	33-1-6461-6329
GBR	emv, Ltd.....	44-1908-566556
ISR	Kfar-Saba, Silram, Ltd.....	972-9-767-1332
ITA	Savona, PMM.....	39 0182 5864
ITA	Torino, Teseo.....	39-011-739651
JPN	Tokyo, Nippon Automatic Control	81-(0)3-5434-1600
NLD	Comtest Instrumentation, B.V.....	31-71-541-7531
SWE	Stockholm, CE-BIT.....	46-8-735-7550

Fotofab 91

3758 Belmont Ave., Chicago, IL 60618 USA; 773-463-
 6211; Fax: 773-463-3387; sales@fotofab.com;
 www.fotofab.com

Frankonia EMC

Industrie Strasse, 16, Heideck, D-91180, Germany; 49 91
 77-98 500; www.frankonia-emc.com

Frontier Electronics, Corp.

667 E. Cochran St., Simi Valley, CA; 805-522-9998; Fax:
 805-522-9989; frontiersales@frontierusa.com;
 www.frontierusa.com

Fuss-EMV

Johann-Hittorf-Strasse 6, 12489 Berlin, Germany; +49
 30-4044004; stefan.weber@fuss-emv.de;
 www.fuss-emv.de

G

Gaddon Consultants

18 New Royd, Millhouse Green Sheffield South Yorkshire
 S36 9NW UK; 01226 766999; Ian White, gaddon@
 gaddon.co.uk; www.gaddon.co.uk

GAUSS Instruments

Agnes-Pockels-Bogen 1, Munich 80992 Germany; +49 89
 84 54 34 45; Fax: +49 89 84 54 34 42; Dipl.-Ing. A. Frech,
 info@tdemi.com; www.gauss-instruments.com

Gaven Industries Inc.

6655 North Noah Drive, Saxonburg, PA; 724-352-8100;
 Fax: 724-352-8121; www.gavenindustries.com

Genisco Filter Corp.

5466 Complex St., Suite 207, San Diego, CA 92108
 USA; 858-565-7405; Fax: 858-565-7515; Dick Guarena,
 sales@genisco.com; www.genisco.com

GETELEC

375, rue Morane Saulnier, 78530, Buc, France; (33) 1 39
 20 42 42; Fax: (33) 01.39.20.42.43; info@getelec.com;
 www.getelec.com

Giga-tronics/Ascor Inc.

4650 Norris Canyon Road, San Ramon, CA 94583 USA;
 925-328-4650; Fax: 925-328-4700; dkwok@gigatronics.
 com; www.gigatronics.com

Glenair Inc.

1211 Air Way, Glendale, CA 91201-2497 USA; 818-247-
 6000; Fax: 818-500-9912; mKaufman@glenair.com;
 www.glenair.com

Global Advantage

180 Brodie Drive, Richmond Hill, ON L4B 3K8, Canada;
 905-883-3919; larry.cook@globaladvantage.ca;
 www.globaladvantage.ca

Global Certification Laboratories, Ltd.

4 Matthews Drive, East Haddam, CT 06423 USA; 860-
 873-1451; Fax: 860-873-1947; janice@globaltestlabs.
 com; www.globaltestlabs.com

Global EMC Ltd.

Prospect Close, Lowmoor Road Ind., Est Kirkby-in-Ash-
 field, Nottinghamshire NG17 7LF, United Kingdom; +44
 (0)1623 755539; Fax: +44 (0)1623 755719;
 information@globalemc.co.uk; www.globalemc.co.uk

Global Testing

4183 Riverview Drive, Riverside, CA 92509 USA; 951-
 781-4540; Fax: 951-781-4544; www.global-testing.com/



Creative Technologies
 Worldwide

W. L. Gore & Associates, Inc. 98, 99

380 Starr Road, Landenberg, PA 19350-9221 USA;
 electronics.usa@wlgore.com; www.gore.com



Gowanda Electronics..... 69

One Magnetics Parkway, Gowanda, NY 14070 USA;
 716-532-2234; Fax: 716-532-2702; sales@gowanda.
 com; www.gowanda.com

Green Mountain Electromagnetics, Inc.

219 Blake Roy Road, Middlebury, VT 05753 USA; 802-
 388-3390; Fax: 802-388-6279; gme@gmelectro.com;
 www.gmelectro.com

GTN GmbH & Co. KG

TecCenter, Bad Salzdetfurth, D-31162, Germany;
 +49(0)5063/270768; Fax: +49(0)5063/270784; Hans-
 Peter Henneberg, emv@gtm-germany.de;
 www.gtm-germany.de/emv

H

H.B. Compliance Solutions

254 W. Baseline Road, Suite # 103, Tempe, AZ 85283
 USA; 480-684-2969; Hoosamuddin Bandukwala, hoo-
 sam@hbcompliance.com; www.hbcompliance.com

Haefely EMC..... 97

1650 Route 22, Brewster, NY 10509 USA; 845-279-
 8091; emcsales@hubbell-haefely.com;
 www.haefelyemc.com; www.hipotronics.com

Harris Corp (GCSD)

P.O. Box 37, M/S 9-11A, Melbourne, FL 32902 USA;
 321-727-6209; Fax: 321-727-4335; James N Boorde,
 jboorde@harris.com

Harwin

7A Raymond Ave., Unit 11, Salem, NH 03079; 603-893-
 5376; Fax: 603-893-5396; misboston@harwin.com;
 www.harwin.com

Heilind Electronics

58 Jonspin Road, Wilmington, MA 01887 USA; 800-555-
 8027; Fax: 440-473-9330; connect2@heilind.com;
 www.heilind.com

Henry Ott Consultants 27

48 Baker Road Livingston, NJ 07039 USA; 973-992-1793;
 Fax: 973-533-1442; Henry W. Ott, h.ott@verizon.net;
 www.hottconsultants.com

Hermon Laboratories

Hatachana Street, P.O. Box 23, Binyamina 30500, Israel;
 +972-4-6268450; sales-tca@hermonlabs.com;
 www.hermonlabs.com

HFC Shielding Prod. Co. Ltd.

515 Valley St., Maplewood, NJ USA; 973-928-7769; emigasket@hotmail.com; www.emigasket.com

High & Low Corporation

7F, No118, Lane235, Pao-Chiao Road, New Taipei City 231, Taiwan; +886 2 8978 1800; Fax: +886 2 8912 1900; Daniel Lin, daniel@hal.com.tw; www.hal.com.tw

Hi-Tech Controls

14853 E. Hinsdale Ave., Suite D, Centennial, CO 80112-4240 USA; 303-680-5159; info@hitechcontrols.com; www.hitechcontrols.com

Hi-Voltage & EMI Corp.

93 Stone Lane, Levittown, NY 11756 USA; 516-644-5486; Fax: 516-735-3585; rfhivoltage2@aol.com; www.hivoltage.li

Holland Shielding Systems BV

Jacobus Lipsweg 124, 3316 BP, Dordrecht ZH 3316 BP Netherlands; 31786131366; Fax: 31786149585; A.M. van Tienhoven, info@hollandshielding.com; www.hollandshielding.com



Holiday Industries, Inc., ETS-Lindgren

1301 Arrow Point Drive, Cedar Park, TX; 512-531-6400; Fax: 512-531-6500; www.ets-lindgren.com

Hoolihan EMC Consulting 27

32515 Nottingham Court, P.O. Box 367 Lindstrom MN 55045 USA; 651-213-0966; Fax: 651-213-0977; Daniel D. Hoolihan, danhoolihanemc@aol.com; www.emcxpert.com



HV TECHNOLOGIES, Inc. 5

8526 Virginia Meadows Drive, Manassas, VA 20109 USA; 703-365-2330; Fax: 703-365-2331; emcsales@hvtechnologies.com; www.hvtechnologies.com

I. Thomas GmbH

An der B73 - 200a,D-21684 Stade, Germany; +49 4141 82920; Fax: +49 04141 84461; Vertrieb@Schirmkabinen.de; www.schirmkabinen.com

Identification Products Corp.

104 Silliman Ave., Bridgeport, CT; 203-334-5969; info@idproducts.com; www.idproducts.com

IMS Engineered Products

One Innovation Drive, DesPlaines, IL 60016 USA; 847-391-8203; Fax: 847-391-8356; Jim Walenda, jwalenda@imsmfg.com; www.imsep.com

iNARTE, Inc.

840 Queen St., New Bern, NC 28560 USA; 252-672-0111; 800-89-NARTE; Fax: 252-672-0111; Lawrence@inarte.us

Inceleris

Latinos 149, Col. Moderna, Mexico, D.F. 3510 Mexico; 52 55 9180 3655; Guillermo Dominguez, ventas@inceleris.com; www.inceleris.com

Ingenium Testing, LLC

3761 South Central Ave., Rockford, IL 61102 USA; 815-315-9250; Fax: 815-489-9561; michael.caruso@ingeniumtesting.com



Instec Filters 69

7426A Tanner Parkway, Arcade, NY 14009 USA; 716-307-8542; Fax: 805.687.8085; sales@instec-filters.com; www.instec-filters.com

Instrument Plastics Ltd.

Unit 35, Kings Grove Industrial Est., Maidenhead, Berkshire SL6 4DP, United Kingdom; +44 01628 770018; Fax: +44 01628 773295; rad@instrumentplastics.co.uk; www.instrumentplastics.co.uk



Instruments For Industry (IFI) 11, 28, 29, 34

903 South Second St., Ronkonkoma, NY 11779 USA; 631-467-8400; Fax: 631-467-8558; www.ifi.com

AZ	AZTEC Enterprises, Inc.	480-858-9511
AK	CF-Scientific Systems	817-467-0970
CA	Advanced Technical Sales (ATS)	925-735-2147
CO	AZTEC Enterprises, Inc.	800-304-3565
CT	dB Instruments Co.	508-238-1303
DE	Contech Marketing	732-634-5501 ext. 307
ID	AZTEC Enterprises, Inc.	800-304-3565
IL	Test Midwest	314-246-0360
IA	Test Midwest	309-343-0203
IN	Micro Sales	614-563-9800
KS	Test Midwest	816-866-0360
KY	Micro Sales	614-563-9800
LA	CF-Scientific Systems	817-467-0970
MA	dB Instruments Co.	508-238-1303
ME	dB Instruments Co.	508-238-1303
MI	Micro Sales	734-770-6269
MN	Test Midwest	612-460-0360
MO	Test Midwest	314-246-0360
MT	AZTEC Enterprises, Inc.	800-304-3565
ND	Test Midwest	612-460-0360
NE	Test Midwest	816-866-0360
NH	dB Instruments Co.	508-238-1303
NJ	Contech Marketing	732-634-5501
NM	AZTEC Enterprises, Inc.	800-304-3565
NV	AZTEC Enterprises, Inc.	800-304-3565
NY	Metro, Long Island, Contech Marketing	732-634-5501 ext. 306
NY	Upstate, dB Instruments Co.	508-238-1303
OH	Micro Sales	614-563-9800
OK	CF-Scientific Systems	817-467-0970
PA	Eastern PA, Contech Marketing	732-634-5501 ext. 307
PA	Western PA, Micro Sales	614-792-9117
RI	dB Instruments Co.	508-238-1303
SD	Test Midwest	612-460-0360
TX	CF Scientific Systems	817-467-0970
UT	AZTEC Enterprises, Inc.	800-304-3565
VT	dB Instruments Co.	508-238-1303
WI	Test Midwest	262-521-3056
WY	AZTEC Enterprises, Inc.	800-304-3565

AUT	EMCO Elektronik	+49 898955650
BEL	Air-parts BV	+31 172422455
BRA	LUNUS	+55 12 3941 8001
CAN	Vancouver, Jerome and Frances Co. Ltd.	604 986-1286
	Ontario, ConformityPlus, Inc.	(613) 841-585
CHN	Beijing, Quatronix, Inc.	8610-5873-1155
	Hong Kong, Quatronix, Inc.	852-35038786
	Shanghai, Quatronix, Inc.	8621-6485-1591
DEU	Planegg-Martinsried, EMCO Elektronik	+49 898955650
DEU	Maintal, Pischzan Technologie	+49 (0) 61 09 77 19 48
DNK	Compomill Nordic Components	+45 44 84 87 00
ESP	Adler Instruments, S.L.	+34-913584046

FIN	Compomill Nordic Components	+358 95 24 470
FRA	EMC Partner France	+33(0)5 55 74 31 68
GBR	DM Systems and Test Ltd.	+44-0 1462-477277
IND	Kaytronics	040-2784-2416/8483
ISR	RCM Systems	972-50-6351111
ITA	Rome, LP Instruments	+39 0640800491
ITA	Trezzano, LP Instruments	+39-0248401713
JPN	Tokyo, Techno Science Japan	+81 357993160
KOR	InfoTech Co.	+82 32 612 8252
MYS	Singapore Technologies Electronics Ltd.	+65 64133119
NLD	EEMC Coimex	+31 320295395
NOR	Compomill Nordic Components	+46 8 594 111 50
POL	Iontronex Corporation	+4822 631 2643
ROM	Rom Tek Electronics SRL	+4021-269.20.08
SGP	Singapore Technologies Electronics Ltd.	+65 64133119
SWE	Compomill Nordic Components	+46 8 594 111 50
THA	Singapore Technologies Electronics Ltd.	+65 64133119
TWN	Honova Resources Ltd.	+88 6282286089, ext. 168
ZA	RF Design	+27 21 555-8400

Insulfab

600 Freeport Pkwy., Suite 150, Coppell, TX 75019 USA; 800-442-1338; Fax: 214-956-0848; John Frederiksen, insulfabsales@conco.com; www.insulfab.net

Integrated Engineering Software

220-1821 Wellington Ave., Winnipeg, Manitoba, R3H 0G4 Canada; 204-632-5636; Fax: 204-633-7780; info@integratedsoft.com; www.integratedsoft.com

Integrated Microwave Corp.

11353 Sorrento Valley Road, San Diego, CA 92121 USA; 858-259-2600; Fax: 858-755-8679; dclark@imcsd.com; www.imcsd.com

Intermark (USA) Inc. 64

1310 Tully Road #117, San Jose, CA 95122 USA; 408-971-2055; Fax: 408-971-6033; sales@intermark-usa.com; www.intermark-usa.com

CA	San Diego, Rina Tsujimoto	858-202-1585
----	---------------------------	--------------

INTERNATIONAL

DEU	Frankfurt, Ichikawa	49-6106 8524 20
HKG	Tsen Wann, Sano	852-2612-1161
JPN	Nagoya, Yoshida	81-52-261-2740
SGP	Singapore, Mori	65-56-6511
TWN	Taipei, Iguchi	886-2-26988833

International Certification Services, Inc.

1100 Falcon Ave., Glencoe, MN 55336 USA; 320-864-4444; 1-888-286-6888; Fax: 320-864-6611; duane@icsi-us.com; www.icsi-us.com

International Compliance Laboratories

1057 Tullar Court, Neenah, WI 54956 USA; 920-720-5555; Fax: 920-720-5556; Ron Zimmerman, rzimmerman@icl-us.com; www.icl-us.com

Intertek Testing Services

70 Codman Hill Road, Boxborough, MA 01719 USA; 978 263 2662; 1-800-VORLDBLAB; Fax: 978 264 9403; hope.mascott@intertek.com; www.intertek.com

INTERTest Systems, Inc.

303 Route 94, Colorado Springs, CO; 719-522-9667; Fax: 908-496-8004; info@intertestinc.com; www.intertest.com

Ion Physics Corp.

373 Main St., P.O. Box 165, Fremont, NH 03044 USA; 603-895-5100; 800-223-0466; Fax: 603-895-5101; sales@ionphysics.com; www.ionphysics.com; Leslie Faunce, Marketing Manager; Helmut Milde, President

IQS, a Div. of The Compliance Management Group

257 Simarano Drive, Marlboro, MA 01752 USA; 508-460-1400; Fax: 508-460-7979; rdunne@cmgcorp.net; www.iqscorp.com

ITC Engineering Services, Inc.

9959 Calaveras Road, Sunol, CA 94586 USA; 925-862-2944; Fax: 925-862-9013; sales@itcemc.com; www.itcemc.com



ITEM Media **31, 51, 74, 95**
 1000 Germantown Pike, Suite F-2, Plymouth Meeting, PA 19462 USA; 484-688-0300; Fax: 484-688-0303; info@interferencetechnology.com; www.interferencetechnology.com; Bob Poust, Business Development Manager

INTERNATIONAL

CHN Beijing, Leadzid 86-10-65250537
 JPN Tokyo, TUV SUD Ohtama, Ltd. 81-44-980-2092

ITL Israel

Bat-Sheva St. 1, POB 87, Lod, Israel; 972 8 9153100; Fax: 972-8-9153101; standard@itl.co.il; www.itl.co.il

ITT Interconnect Solutions

666 East Dyer Road, Santa Ana, CA 92705 USA; 714-628-8277; Fax: 714-628-8470; christine.stieglitz@btbmarketing.com; www.ittcannon.com

ITW/Pressure Sensitive Adhesives & Components

90 James Way, Southampton, PA 18966; 215-322-1600; Fax: 215-322-1620; info@mcspecialties.com; www.mcspecialties.com

J



Ja-Bar Silicone Corporation

252 Brighton Road, P.O. Box 1249, Andover, NJ 07821 USA; 973-786-5000; Fax: 973-786-5546; Mark Derr, V.P. EMI Division, mderr@ja-bar.com; www.jabar.com

Jacobs Technology Inc.

3300 General Motors Road, Milford, MI 48380 USA; 248-676-1123; www.jacobstechnology.com

Jastech EMC Consulting, LLC

P.O. Box 3332, Farmington Hills, MI; 248-876-4810; info@jastech-emc.com; www.Jastech-EMC.com

JEMIC Shielding Technologies

1160 S. Cameron St., Harrisburg, PA 17104 USA; 717-232-1030; dietrich@jemic.com; www.jemic.com

JiangSu WEMC Technology Co., Ltd.

No. 8, JianYe Road, TianMu Lake, Industrial Park LiYang Jiangsu 213300 China; +86 519 8796 1998; Fax: +86 519 8746 5666; Youliang Wei, weiyi@wemctech.com; www.wemctech.com

Jinan EMI Shielding Technology Co., Ltd.

509, No.792 Hualong Road, Jinan Shandong 250100 China; 8.65318E+12; Fax: 8.65318E+12; Sunny Li, info@emishielding.com.cn; www.emishielding.com.cn

JINAN Filtemc Electronic Equipment Co., Ltd.

9 Lanxiang Road, Jinan ID 250032, China; +86 531 85738859; Fax: +86 531 85717366; lwl@filtemc.com; www.filtemc.com

Johanson Dielectrics, Inc.

15191 Bledsoe St., Sylmar, CA 91342 USA; 818-364-9800; scole@johansondielectrics.com; www.johansondielectrics.com

JRE Test, LLC.

1350 Pittsford-Mendon Road, Mendon, NY 14506 USA; 585-298-9736; 888-430-3332; Fax: 585-919-6586; brian@jrestest.com; www.jrestest.com

JS TOYO Corporation (Shenzhen) Ltd.

2-25G, China Phoenix Building Futian CBD, Shenzhen, 518026 China; www.jstoyo.cn

K

K-Form, Inc.

9A Acacia Lane, Sterling, VA 20166 USA; 703-450-4401; Fax: 703-894-4914; kform@kform.com; http://manufacturing.kform.com



Kemtron Limited

19-21 Finch Drive, Braintree, Essex CM7 2SF, United Kingdom; +44 1376 348115; Fax: +44 1376 345885; info@kemtron.co.uk; www.kemtron.co.uk



Kensington Electronics, Inc. **77, 93**

11801 Stonehollow Drive, Ste. 150, Austin, TX 78758 USA; 512-339-3300; Fax: 512-833-8034; www.keiconn.com

Keystone Compliance

2861 West State Street, New Castle, PA 16101 USA; 724-657-9940; Fax: 724-657-9920; tony@keystonecompliance.com; www.keystonecompliance.com

Kikusui America Inc.

1633 Bayshore Hwy., Suite 331, Burlingame, CA 94010 USA; 650-259-5900; Fax: 650-259-5904; itoko@kikusuiamerica.us; www.kikusuiamerica.us

Kimmel Gerke Associates, Ltd. **27**

2538 West Monterey Ave., Mesa, AZ 85202 USA; 888-EMI-GURU; Daryl Gerke, dgerke@emiguru.com; www.emiguru.com
 628 LeVander Way, South Saint Paul, MN 55075 USA; 888-EMI-GURU; Bill Kimmel, bkimmel@emiguru.com; www.emiguru.com

Kycon

11810 Little Orchard St., San Jose, CA 95125 USA; 408-494-0330; jill_scarnechia@kycon.com; www.kycon.com

L

L. Gordon Packaging

22 W. Padonia Road, Suite 304A, Timonium, MD 21093 USA; 410-308-2202; Fax: 410-308-2207; lgordonpkg@verizon.net; www.lgordonpackaging.com

L.S. Research

W66 N220 Commerce Court, Cedarburg, WI 53012 USA; 262-375-4400; Fax: 262-375-4248; www.lsr.com

L-3 Communications Cincinnati Electronics

7500 Innovation Way, Mason, OH 45040-9699 USA; 513-573-6809; Fax: 513-573-6499; Steven Davis, Steven.Davis@L-3Com.com; www.L-3Com.com/ce

Laboratory Testing Inc.

2331 Topaz Drive, Hatfield, PA 19440 USA; 800-219-9095; Fax: 800-219-9096; sales@labtesting.com; www.labtesting.com

Laird Technologies

3481 Rider Trail S., Earth City, MO 63045 USA; 636-898-6215; Fax: 636-898-6100; Jannette Avila, jannette.avila@lairdtech.com; www.lairdtech.com

Lamart Corp.

16 Richmond St., Clifton, NJ 07011 USA; 973-772-6262; sreidenbach@lamartcorp.com; www.lamartcorp.com

Langer EMV-Technik GmbH **39**

Noethnitzer Hang 31, Bannewitz, 01728, DE, 0351-430093-23; michak@langer-emv.de; www.langer-emv.de

Laplace Instruments Ltd.

3B, Middlebrook Way, Holt Road, Cromer, Norfolk, NR27 9JR, UK; +44 (0) 12 63 51 51 60; Fax: +44 (0) 12 63 51 25 32; tech@laplace.co.uk; www.laplaceinstruments.com

Lapp USA

29 Hanover Road, Florham Park, NJ 07932 USA; 973-660-9700; 800-774-3539; Fax: 973-660-9330; mbroe@lappusa.com; www.lappusa.com



LCR Electronics, Inc. **64**

9 S. Forest Ave., Norristown, PA 19401 USA; 800-527-4362; 610-278-0840; Fax: 610-278-0935; Eric A. Kessler, sales@lcr-inc.com; www.lcr-inc.com

Leader Tech, Inc.

12420 Race Track Road, Tampa, FL 33626 USA; 813-855-6921; 866-832-4364; Fax: 813-855-3291; Tim Black, tblack@leadertechinc.com; www.leadertechinc.com

LEDE-SIECIT

48 & 116 St., La Plata, Buenos Aires 1900, Argentina; +54 11 221 4250877; lede@ing.unlp.edu.ar

Less EMF Inc.

809 Madison Ave., Albany, NY 12208; 518-432-1550; Fax: 309-422-4355; lessemf@lessemf.com; www.lessemf.com

LF Research EMC

12790 Route 76, Poplar Grove, IL 61065; 815-566-5655; FAX: 815-547-3467; info@lfrsearch.com; www.lfrsearch.com;

LGS Technologies

2950 W. Wintergreen, P.O. Box 763039, Lancaster, IA 75134 USA; 972-224-9201; 1-800-441-5470; Fax: 972-228-0652; crobles@lgsco.com; www.lgstechologies.com

Liberty Labs, Inc. **25**

1346 Yellowwood Road, P.O. Box 230, Kimballton, IA 51543 USA; 712-773-2199; Fax: 712-773-2299; Mike Howard, President/CEO, info@liberty-labs.com; www.libertylabs.com

INTERNATIONAL

JPN Yokohama, Mitsunobu Samoto 81-45-500-1280

For more information on these and other EMI/EMC companies, visit the new and improved Interference Technology EMC Buyers' Guide at www.interferencetechnology.com

Lightning Eliminators & Consultants, Inc.

6687 Arapahoe Road, Boulder, CO 80303; 303-447-2828;
Fax: 303-447-8122; www.leglobal.com

Lightning Technologies, Inc.

10 Downing Industrial Parkway, Pittsfield, MA 01201-3890 USA; 413-499-2135; Fax: 413-499-2503;
Mary Cancellia, cancellia@lightningtech.com;
www.lightningtech.com

Little Mountain Test Facility

12000 W.12th St., Ogden, UT 84404 USA; 801-315-2320

Littlefuse Inc.

8755 W. Higgins Road, Suite 500, Chicago, IL; 773-628-1000; Fax: 847 759 0272; www.littlefuse.com

LTI Metrology

2331 Topaz Drive, Hatfield, PA 19440; 800-784-2882;
Fax: 800.219.9096; sales@labtesting.com;
www.labtesting.com

Lubrizol Conductive Polymers

9911 Brecksville Road, Brecksville, OH 44141 USA;
888-234-2436; Fax: 216-447-6232; kew@lubrizol.com;
www.statrite.com

Lutze Inc.

13330 South Ridge Drive, Charlotte, NC 28273 USA;
704-504-0222; 1-800-447-2371; Fax: 704-504-0223;
sgregson@lutze.com; www.lutze.com

M**M&C Specialties**

90 James Way, Southampton, PA 18966 USA; 215-322-7441 x 124; Fax: 215-322-1620; Dave Cornelison, dcornelison@mcspecialties.com; www.mcspecialties.com

M.MARDIGUIAN, EMC Consulting

2 Allée des Chataigniers, St Remy les Chevreuse
78470 France; 00 33 (0)1 30 52 97 25; Fax: 00 33 (0)1 30 52 97 25; Michel Mardiguian, m.mardiguian@orange.fr

Macton Corporation

116 Willenbrock Road, Oxford, CT 06478 USA; 203-267-1500; Fax: 203-267-1555; Jack Shepherd, jshepherd@macton.com; www.macton.com

Magnetic Radiation Laboratories

690 Hilltop Drive, Itasca, IL 60143 USA; 630-285-0800;
888-251-5942; Fax: 630-285-0807; admin@magrad.com;
www.magrad.com

Magnet Industry Ltd.

No.6, Chung-Hsin Road, Chung-Hsin Industrial Park,
Maio-Li Taiwan 366 Taiwan; 886-2-25149690; Fax: 886-2-25149145; Simon Hsu, simon@ferrite.com.tw;
www.ferrite.com.tw

Magnetic Shield Corp.

740 Thomas Drive, Bensenville, IL 60106 USA; 630-766-7800; Fax: 630-766-2813; Brad Friestedt, shields@magnetic-shield.com; www.magnetic-shield.com

MAJR Products Corp.

17540 State Highway 198, Saegertown, PA 16433 USA;
814-763-3211; 877-625-7776; Fax: 814-763-2952; terry@majr.com; www.majr.com

Marktek Inc.

13621 Riverway Drive, Suite H, Chesterfield, MO 63017 USA; 314-878-9190; 866-364-6285; Fax: 314-878-9558;
Pres. arhenn@marktek-inc.com; www.marktek-inc.com

Master Bond Inc.

154 Hobart St., Hackensack, NJ 7601 USA; 201-343-8983; Fax: 201-343-2132; Robert Michaels, main@masterbond.com; www.masterbond.com

Materion Brush Performance Alloys (formerly Brush Wellman) 86

6070 Parkland Blvd., Mayfield Heights, OH 44124 USA; 800-321-2076; 216-383-4005; Jimmy Johnson, BrushAlloys-Info@materion.com; http://materion.com/brushalloys

matur GmbH

Bahnhofstr. 26, 92536 Pfreimd, Germany; +49 9606 9239130; Fax: +49 (0) 9606 923913-29; info@matur-gmbh.de; www.matur-gmbh.de

MCG Surge Protection

12 Burt Drive, Deer Park, NY 11702 USA; (800) 851-1508; (631) 586-5125; Fax: (631) 586-5120; info1@mcgsurge.com; www.mcgsurge.com

MCL, Inc., A MITEQ Company

501 S. Woodcreek Drive, Bolingbrook, IL 60440 USA; 630-759-9500; Fax: 630-759-5018; sales@mcl.com; www.mcl.com

MEC Kitagawa

Marcom House, 1 Steam Mill Lane, Great Yarmouth, Norfolk NR31 0HP, United Kingdom; 4.41494E+11; Fax: 01493 668623; Michael Baker, michael@marcomuk.co.uk; www.meckitagawa.co.uk

Mech-Tronics

1635 N. 25th Ave., Melrose Park, IL 60160 USA; 708-344-9823 ext.638; 1-800-989-9823; Fax: 708-344-0067; bob.feiler@mech-tronics.com; www.mech-tronics.com

MegaPhase LLC 72

2080 Hamilton Road East, Stroudsburg, PA 18360; 570-424-8400; Fax: 570-424-6031; www.megaphase.com

Mekoprint A/S Chemigraphics

Mercurvej 1, DK-9530 Støvring, Denmark; +45 9936 5618; Fax: +45 9936 5603; sk@mekoprint.dk; www.mekoprint.dk

Mercury United Electronics Inc.

9299 9th St., Rancho Cucamonga, CA 91730 USA; 909-466-0427; Fax: 909-466-0762; Art Trejo, art-trejo@mercury-crystal.com; www.MercuryUnited.com

Mesago Messe Frankfurt GmbH 119

Rotebuehlstrasse 83-85, Stuttgart, D-70178, Germany; www.mesago-online.de/en; 49 711 61946 26

MET Laboratories, Inc.

914 W. Patapasco Ave., Baltimore, MD 21230 USA; 410-354-3300; 800-638-6057; Fax: 410-354-3313; info@metlabs.com; www.metlabs.com

Metal Textiles Corp.

970 New Durham Road, Edison, NJ 08818 USA; 732-287-0800; Fax: 732-287-8546; John Soltis, jsoltis@metexcpcorp.com; www.metexcpcorp.com

Metatech Corporation

358 South Fairview Avenue Suite E, Goleta, CA; 805-683-5681; Fax: 805-683-3023; info@metatechcorp.com; www.metatechcorp.com

MH&W International Corp.

14 Leighton Place, Mahwah, NJ 07430 USA; 201-891-8800; 866-MHW-CORE; Fax: 201-891-0625; garyv@mhw-intl.com; www.mhw-intl.com

Micrometals, Inc.

5615 E. La Palma Ave., Anaheim, CA 92807; 714-970-9400; Fax: 714-970-0400; sales@micrometals.com; www.micrometals.com

Michigan Scientific Corp.

321 East Huron St., Milford Michigan 48383 USA; 248-685-3939; Fax: 248 684-5406; Paul Morand, fiber@michscimfd.com; www.michsci.com

Micronor, Inc.

750 Mitchell Road, Newbury Park, CA 91320-2213 USA; 805-499-0114; Fax: 805-499-6585; Dennis Horwitz, sales@micronor.com; www.micronor.com

Mihajlo Pupin Institute-EMC Lab.

Volina 15 Street, Belgrade, Serbia 11000 Serbia; 38162369796; Fax: 3.81113E+11; Nikola Nenadic, nikola.nenadic@pupin.rs; www.pupin.rs

MILMEGA Ltd.

Ryde Business Park, Park Road, Ryde Isle of Wight PO33 2BE, United Kingdom; +44 (0)1983 618004; Fax: +44 (0)1983 811521; joeley@milmeaga.co.uk; www.milmeaga.com

MIRA Ltd.

Watling St., Nuneaton, Warwickshire CV10 0TU, United Kingdom; +44 (0) 2476 355 5000; Fax: +44 (0)2476 355 8000; matthew.farmer@mira.co.uk; www.mira.co.uk

Mitsubishi Digital Electronics America Inc.

9351 Jeronimo Road, Irvine, CA 92618-1904 USA; 949-465-6206

MKS Instruments

2 Tech Drive, Suite 201, Andover, MA 01810 USA; 978-645-5500; mks@mksinst.com; www.mksinst.com

Modpak, Inc.

97 Mudgett Road, Kenduskeag ME 4450 USA; 207-884-8285; Fax: 207-884-8712; Jeff Billington, modpak@roadrunner.com; www.modpak.com

Montena EMC

Route de Montena 89, Rossens 1728 Switzerland; +41 26 411 84 84; Fax: +41 26 411 17 79; François Volery, products@montena.com; www.montena.com

Montrose Compliance Service, Inc. 27

2353 Mission Glen Drive, Santa Clara, CA 95051-1214 USA; 408-247-5715; mark@montrosecpliance.com; www.montrosecpliance.com

MOOSER Consulting GmbH

Amtmannstrabe 5, Egling/Thanning, 82544 Germany; 49-8176 92250; http://mooser-consulting.de/en_index.php?lang=english

Moss Bay EDA

23889 NE 112th Circle #2, Redmond, WA 98053 USA; 206-779-5345; Fax: 484-730-5345; gene@mossbayeda.com; www.mossbayeda.com

MPB Srl

Via Giacomo Peroni 400/402, Rome, RM 131, Italy; 0039-06-41200744; Fax: 0039-06-41200653; Silvia Petrelli, marketing@gruppompb.com; www.gruppompb.co.uk

MPE Limited

Hammond Road, Knowsley Industrial Estate, Liverpool L33 7UL UK; +44 (0) 151 632 9100; Fax: +44 (0) 151 632 9112; Paul Currie, sales@mpe.co.uk; www.mpe.co.uk

MTI - Microsorb Technologies, Inc.

32 Mechanic Ave., Unit 211, Woonsocket, RI 02895-0089 USA; 401-767-2269; 401-767-2255; engineer@microsorbtech.com; www.microsorbtech.com

Mueller Corp.

530 Spring St., East Bridgewater, MA 02333 USA; 508-583-2800; Fax: 508-378-4744; glenn@muellercorp.com; www.muellercorp.com

Murata Electronics North America

2200 Lake Park Drive, Smyrna, GA 30080-7604 USA; 770-436-1300; 800-241-6574; Fax: 770-805-3192; rosenfeld@murata.com; www.murata.com

MuShield Company, Inc. 90

9 Ricker Ave., Londonderry, NH 03053 USA; P.O. Box 5045, Manchester, NH 03108-5045; 603-666-4433 ext. 21; 888-669-3539; Fax: 603-666-4013; (800)666-4013; info@mushield.com; www.mushield.com

N



Narda Safety Test Solutions, S.r.l. 37
Via Leonardo da Vinci, 21/23 20090 Segrate (MI) Italy;
+39 02 2699871; Roberto Grego; support@narda-sts.it;
www.narda-sts.it

National Magnetics Group, Inc.
1210 Win Drive, Bethlehem, PA; 610-761-7600; Fax: 610-867-0200; sales@magneticsgroup.com;
www.magneticsgroup.com

National Technical Systems..... 1
Headquarters: 24007 Ventura Blvd., Suite 200, Calabasas, CA 91302 USA; 800-270-2516; Fax: 818-591-0899; sales@nts.com; www.nts.com; Tom Wetzell, Director of Corporate Marketing

AR	Camden, NTS Camden	870-574-0031
AZ	Tempe, NTS Tempe	480-966-5517
CA	Culver City, NTS Culver City	800-879-9225
	Fremont, NTS Silicon Valley	877-245-7800
	Fullerton, NTS Fullerton	800-677-2687
	Los Angeles, NTS LAX	310-348-0900
	Newark, NTS Silicon Valley	877-245-7800
	Santa Clarita, NTS Santa Clarita	661-259-8184
IL	Rockford, NTS Rockford	815-315-9250
IN	Indianapolis, NTS Indianapolis	317-241-8248
KS	Wichita, NTS-USTL	316-832-1600
MA	Acton, NTS Acton	978-263-2933
	Boxborough, NTS Boxborough	978-266-1001
	Pittsfield, NTS Pittsfield (LTI)	413-499-2135
MI	Detroit, NTS Detroit	313-835-0044
NJ	Tinton Falls, NTS New Jersey	732-936-0800
TX	Plano, NTS Plano	972-509-2566
VA	Rustburg, NTS Rustburg/DTI	434-846-0244
	INTERNATIONAL	
EUR	NTS Europe	+49-89-787475-160



Naval Air Systems Command..... 39
NAVIAIR E3 Division - Code 4.1.13, Bldg. 4010, Room 134, 48187 Standley Road, Patuxent River, MD 20670 USA; 301-342-1660; Fax: 301-757-2381; Mike Squires, E3 Division Manager, michael.squires@navy.mil;
www.navair.navy.mil

Naval Air Warfare Center
Aircraft Division - E3 Branch Code 5.4.4.5 Hangar 144, Suite 3B, Unit 5, 48202 Standley Road, Patuxent River, MD 20670-1910 USA; 301-342-1663; Fax: 301-342-6982;
www.navair.navy.mil

NCEE Labs
4740 Discovery Drive, Lincoln, NE 68521-5376 USA; 402-472-5880; 888-567-6860; Fax: 402-472-5881; dkramer@nceelabs.com; www.nceelabs.com

NEDC Fabricating Solutions
42 Newark St., Haverhill, MA 01832; (978)374-0789;
www.nedc.com

Nemko USA
802 North Kealy Ave., Lewisville, TX 75057 USA; 972-436-9600; bruce.ketterling@nemko.com;
www.nemko.com

NewPath Research L.L.C.
2880 S. Main St., Salt Lake City, UT 84115 USA; 801-573-9853; mahagmann@newpathresearch.com;
www.newpathresearch.com

NEXIO
46 Avenue du General de Crouette, Toulouse 31100, France; +33 (0)5 61 44 02 47; Fax: +33 (0)5 61 44 05 67; sales@nexio.fr; www.nexio.fr

Nextek
439 Littleton Road, Westford, MA 01886 USA; 978-486-0582; Fax: 978-486-0583; araymond@nexteklightning.com; www.nexteklightning.com



Noise Laboratory Co., Ltd. 23
1-4-4, Chiyoda, Chuo-ku, Sagami-hara City, Kanagawa Pref 252-0237, Japan; +81-42-712-2051; Fax: +81-42-712-2050; Yuji Kimizuka, Senior Manager, sales@noiseken.com; www.noiseken.com

NY	New York, Shinyei Corp. of America	917-484-7893
	INTERNATIONAL	
AUS	DHS Elmea Tools GmbH	411-813-5380-0
BRA	Sao Paulo, T&M Instruments	55-11-5092-5229
CHN	Hong Kong, Corad Technology Ltd.	852-27930330
	Shenzhen, Corad Technology Ltd.	86-755-83761117
	Shenzhen, Shenzhen HaoGu Technology Co., Ltd.	86 0755 8398 8565
	Shenzhen, Rico Tools Trading Limited	86-755- 83600838
	Shenzhen, Nihon Denkei Co., Ltd.	86-755-8209-6179
	Shanghai, Rico Kohki (Shanghai) Co., Ltd.	86-21-63537223
	Shanghai, Shanghai Sanki Electronics Industries Co., Ltd.	86-21-6257-4333
	Shanghai, Nihon Denkei Co., Ltd.	86-21-5820-9710
	Dalian, Nihon Denkei Co., Ltd.	86-411-8762-2136
	Tianjin, Nihon Denkei Co., Ltd.	86-22-8386-5887
	Beijing, Nihon Denkei Co., Ltd.	86-10-5131-1181
	Dongguan, Nihon Denkei Co., Ltd.	86-769-2202-6986
DEU	Rodemark, DHS Elmea Tools GmbH	49-6074-9199080
IDN	Jakarta, Nihon Denkei Co. Ltd.	62-21 8087-1621
IND	Chennai, MEL Systems and Services Ltd.	91-44-2496-1903
	Bangalore, Complus Systems Pvt. Ltd.	91-80-4168-3883
	Bangalore, Nihon Denkei India Private Limited	91-80-4093-5381
ISR	Ramat Gan, IES Electronics Agencies (1986) Ltd.	972-3-7530751
ITA	Druento, TESEO SpA	39-11-994 1911
KOR	Seoul, Noise Technology Co. Ltd.	82-31-781-7816
MYS	Kuala Lumpur, Nihon Denkei (Malaysia) Sdn Bhd	60-3-2283-5702
	Selangor Daurul Ehsan, AMPTRONIC (M) SDN. BHD.	60-3-5632-8411
PHL	Makati City, Nihon Denkei Co., Ltd.	63-2-8452638
SGP	NihonDenkei Co. Ltd.	65-6355-0851
THA	Bangkok, Nihon Denkei Co. Ltd.	66-2-675-5688
	Bangkok, Industrial Electrical Co., Ltd.	66-2-642-6700
TWN	Taipei, Precision International Corp.	886-2-8512-4888
VNM	Hanoi, Nihon Denkei (Vietnam) Co., Ltd.	84-4-951-6505

Nolato Silikonteknik
Bergmansv 4, Hallsberg 702 16, Sweden; +46 582 88900; magnus.johansson@nolato.se; www.nolato.se/
silikonteknik

Northern Technologies Corp.
95 Konrad Crescent, Markham, Ontario L3R 8T8, Canada; 905-475-9320; 800-456-1875; Fax: 905-475-5719; chrismarshall@northerntech.com;
www.northerntech.com

Northwest EMC, Inc.
41 Tesla, Irvine, CA 92618 USA; 888-364-2378;
www.nwemc.com

NP Technologies, Inc.
2393 Teller Road #108, Newbury Park, CA 91320 USA; 805 376-9299; Fax: 805 376-9288; sales@nptrf.com;
www.nptrf.com

Nu Laboratories, Inc.
312 Old Allerton Road, Annandale, NJ; 908-713-9300; Fax: 908-713-9001; webmaster@nulabs.com;
www.nulabs.com

O

Oak-Mitsui Technologies
80 1st St., Hoosick Falls, NY 12090 USA; 518-686-8088; Fax: 518-686-8080; john.andresakis@oakmitsui.com;
www.oakmitsui.com

Okaya Electric America, Inc.
52 Marks Road, Suite 1, Valparaiso, IN 46383 USA; 800-852-0122; Fax: 219-477-4856; ross@okaya.com;
www.okaya.com

OPHIR RF 55
5300 Beethoven St., Los Angeles, CA 90066 USA; 310-306-5556; Fax: 310-577-9887; sales@ophirrf.com;
www.ophirrf.com; Ed Davis, Sales Manager

Orbel Corp.
2 Danforth Drive, Easton, PA 18045 USA; 610-829-5000; Fax: 610-829-5050; lgralico@orbel.com;
www.orbel.com

ORBIT Advanced Electromagnetics, Inc. (AEMI)
P. O. Box 711719, Santee, CA 92072-1719 USA; 619-449-9492; Fax: 619-449-1553; www.aemi-inc.com

Orion Industries Inc.
One Orion Park Drive, Ayer, MA; 978-772-6000; Fax: 978-772-0021; www.orionindustries.com

Oxley Developments Company Ltd.
Priory Park, Cumbria, Ulverston LA12 9QG, United Kingdom; +44 0 1229 840519; Fax: +44 0 1229 870451; m.blows@oxley.co.uk; www.oxleygroup.com

P



P & P Technology Ltd.
Finch Drive, Springwood Industrial Estate, Braintree, Essex, CM7 2SF United Kingdom; +44 (0) 1376 550525; Fax: +44 (0) 1376 552389; info@p-p-t.co.uk; www.p-p-t.co.uk

Pacific Aerospace & Electronics, Inc.
434 Olds Station Road, Wenatchee, WA 98801 USA; 509-665-8000; Fax: 509-663-5039; rkalkowski@pacaero.com; www.pacaero.com

Paladin EMC
65 Buckwheat Ave., Portsmouth, RI 02871 USA; 401-924-3700; spence@paladinemc.com;
www.paladinemc.com

Panashield, Inc......**Inside Back Cover**
185R West Norwalk Road, Norwalk, CT 06850-4312 USA; 203-866-5888; Fax: 203-866-6162; Peggy Girard, VP/GM, girard@panashield.com; www.panashield.com

Panasonic Electronic Components
Three Panasonic Way, 7H-2 Secaucus, NJ 07094 USA; 1-800-344-2112; Fax: 201-348-7393; piccomponentsmarketing@us.panasonic.com;
www.panasonic.com/industrial/electronic-components/

Parker EMC Engineering
15246 Daphne Ave., Gardena, CA 90249-4122 USA; 310-323-4188; Fax: 310-323-4188; parkeremc@worldnet.att.net; http://parkeremc.mustbehere.com

Partnership for Defense Innovation

455 Ramsey St., Fayetteville, NC 28301 USA; 910-307-3060; Fax: 910-307-3007; info@ncpdi.org; www.ncpdi.org

Pasternack Enterprises

P.O. Box 16759, Irvine, CA 92623 USA; 1-866-727-8376; Fax: 949-261-7451; shaun@pasternack.com; www.pasternack.com

Peak Electromagnetics Ltd.

139 Bank St., Macclesfield, Cheshire SK11 7 AY, United Kingdom; +44 01625 2698080; ian.pocock@peak-em.co.uk; www.peak-em.co.uk

Pearson Electronics, Inc. 52

4009 Transport St., Palo Alto, CA 94303 USA; 650-494-6444; Fax: 650-494-6716; sales@pearsonelectronics.com; www.pearsonelectronics.com

INTERNATIONAL

CAN	Mississauga, ACA TMETRIX.....	800-665-7301
CHE	Lengwil-Oberhofer, Telemeter Elect.....	41-71-6992020
CHN	Corad Technology Ltd., T&M.....	852-2793-0330
DEU	Munchen, Nuclotron Vertriebs GmbH.....	49-89-14900220
FRA	Evry Cedex, BFI OPTILAS SA.....	33-1-60-79-59-01
GBR	Newbury, Alrad Instruments.....	44-1-635-30345
ISR	Kfar Saba, Phoenix Technologies, Ltd.....	972-9-7644800
ITA	Milan, Hi-Tec S.R.L.....	39-2-39266561
JPN	Tokyo, Seki Technotron Corp.....	03-3820-1716
KOR	Seoul, Blue & Green Trading Co.....	82-2-2026-4444
MEX	Mexico City, INyMET Instrumentation.....	55-5574-3087
NLD	Eindhoven, Ohmtronic BV.....	31-40-2573148
NOR	Oslo, Semitronics AS.....	47-22-80-49-20
SAU	Broadway, Denver Tech. Prods.....	27-11-626-2023
SWE	Orebro, Trinerig AB.....	46-19-18-86-60

PennEngineering

5190 Old Easton Road, Danboro, PA 18916 USA; 215-766-8853; Fax: 215-766-0143; gkelly@penn-eng.com; www.pennet.com

Percept Technology Labs, Inc.

4888 Pearl East Circle, #110, Boulder, CO 80301 USA; 303-444-7480; www.percept.com

PGMC Ltd.

Suite 34, Gunnery House, 9 Gunnery Terrace, London, SE18 6SW, United Kingdom; Tel: +44 (0) 20 7193 1730; Pablo Garcia, pablog@o2.co.uk

Philips Applied Technologies - EMC center

5190 Old Easton Road, Danboro, PA 18916 USA; 215-766-8853; Fax: 215-766-0143; gkelly@penn-eng.com; www.pennet.com

Philips Innovation Services-EMC center

High Tech Campus 26, PO box 80036, Eindhoven, Noord Brabant 5656AE The Netherlands; +31-40-2746771; Fax: +31-40-2742233; emc.testlab@philips.com; www.emc.philips.com

Phoenix Contact

586 Fulling Mill Road, Middletown, PA 17057 USA; 717-944-1300; Fax: 717-944-1625; info@phoenixcon.com; www.phoenixcontact.com/usa_home

Photofabrication Engineering Inc.

500 Fortune Drive, Milford, MA 01757 USA; 508-478-2025; Fax: 508-478-3582; clehrer@photofabrication.com; www.photofabrication.com

Pioneer Automotive Technologies, Inc. - EMC Lab

100 S. Pioneer Blvd., Springboro, OH 45066 USA; 937-746-6600 ext. 363; Fax: 937-746-6828; mark.condon@pioneer-usa.com; www.pioneeremc.com

Plastic-Metals Technology Inc.

7051 SW Sandburg Road, Ste. 200, Tigard, OR; 503-684-0725; Fax: 503-684-0735; www.p-mtinc.com

Positronic Industries

423 N. Campbell Ave., P.O. Box 8247, Springfield, MO 65806 USA; 417-866-2322; 800-641-4054; Fax: 417-866-4115; lscheffler@connectpositronic.com; www.connectpositronic.com

Potters Industries, Inc.

P.O. Box 840, Valley Forge, PA 19482 USA; 610-651-4704; Fax: 610-408-9724; mark.bricker@pottersbeads.com; www.pottersbeads.com

Power & Controls Engineering Ltd.

4 Foothills Drive, Ottawa, Ontario K2H 6K3, Canada; 613-829-0820; Fax: 613-829-8127; mail@pcel.ca; www.pcel.ca

Power Products International Ltd.

Commerce Way, Edenbridge, Kent TN8 6ED, United Kingdom; +44 (0) 1732 866424; Fax: +44 (0) 1732 866399; gkrobinson@ppi-uk.com; www.ppi-uk.com

Power-Electronics Consulting

4 Tyler Road, Lexington, MA 02420-2404 USA; 781-862-8998; nathansokal@gmail.com

Power Standards Lab (PSL)

2020 Challenger Drive #100, Alameda, CA; 510-919-4369; Fax: -510-522-4455; Sales@PowerStandards.com; www.powerstandards.com

PPM (Pulse Power & Measurement) Ltd.

65 Shrivenham, Hundred Business Park, Watchfield, Swindon SN6 8TY, United Kingdom; +44 1793 784389; Fax: +44 1793 784391; sales@ppm.co.uk; www.point2point.co.uk

Praxsym, Inc.

120 S. Third St., P.O. Box 369, Fisher, IL 61843 USA; 217-897-1744; Fax: 217-897-6388; jmeissen@praxsym.com; www.praxsym.com

Precision Photo-Fab, Inc.

4020 Jeffrey Blvd., Buffalo, NY 14219; 716-821-9393; Fax: 716-821-9399; www.precisionphotofab.com

Product Safety Engineering Inc.

12955 Bellamy Brothers Blvd., Dade City, FL 33525 USA; 352-588-2209; Fax: 352-588-2544; arobbins@pseinc.com; www.pseinc.com

Professional Testing (EMI), Inc.

1601 N. A.W. Grimes, Suite B, Round Rock, TX 78665 USA; 512-244-3371; www.ptitest.com

Progressive Fillers International

2404 East 28th St., P.O. Box 72709, Chattanooga, TN 37407 USA; 1-423-629-0007; 1-888-988-0007; Fax: 1-423-629-0444; kevin@pfillers.com; www.progressivefillers.com

Prostat Corp.

1072 Tower Lane, Bensenville, IL 60106; 630-238-8883; Fax: 630-238-9717; www.prostatcorp.com

Protek Test and Measurement

45 Smith St., Englewood, NJ 07631 USA; 201-227-1161; Fax: 201-227-1169; sgkim@protektest.com; www.protektest.com

Protocol Data Systems Inc.

4741 Olund Road, P.O. Box 28945 Mctavish Road, Abbotsford, British Columbia V4X 2A1, Canada; 604-607-0012; Fax: 604-607-0019; parms@protocol-emc.com; www.protocol-emc.com

PSC Electronics

2307 Calle Del Mundo, Santa Clara, CA 94086 USA; 408-737-1333; 800-654-1518; Fax: 408-737-0502; eddie@pscelex.com; www.pscelex.com

Pulver Laboratories Inc.

320 North Santa Cruz Ave., Los Gatos, CA 95030-7243 USA; 408-399-7000; 800-635-3050; Fax: 408-399-7001; Lee.Pulver@PulverLabs.com; www.PulverLabs.com

Q

QEMC

Rio de Janeiro, Brazil; (+55.21) 8111 6661; www.QEMC.com.br

QinetiQ

Cody Technology Park, Ively Road, Farnborough, Hants GU14 0LX, United Kingdom; +44 1252 393437; Fax: +44 1252 397058; emcfocus@qinetiq.com; www.QinetiQ.com/emc

Q-par Angus Ltd.

Barons Cross Laboratories, Leominster, Herefordshire HR6 8RS, United Kingdom; +44 (0)1568 612138; Fax: +44 (0)1568 616373; julian.robbins@q-par.com; www.q-par.com

Qualtek Electronics Corp.

7675 Jenther Drive, Mentor, OH 44060 USA; 440-951-3300; Fax: 440-951-7252; bgrubb@qualtekusa.com; www.qualtekusa.com

Qualtest Inc.

5325 Old Winter Garden Road, Orlando, FL 32811 USA; 407-313-4230; Fax: 407-313-4234; chebda@qualtest.com; www.qualtest.com

Quarterwave Corp.

1300 Valley House Drive, Suite 130, Rohnert Park, CA 94928 USA; 707-793-9105; Fax: 707-793-9245; paul@quarterwave.com; www.quarterwave.com



Quell Corporation 61

5639-B Jefferson, NE Albuquerque, NM 87109 USA; 877-730-1669; 505-243-1423; Fax: 505-243-9772; Kevin Foreman, eeseal@quell.us; www.eeseal.com

R

R. A. Mayes Company, Inc.

10064 Deerfield Road, Franktown, CO 80116 USA; 800-742-9447; 303-761-5067; Eric Evans, sales@ramayes.com; www.ramayes.com

Radiometrics Midwest Corp. 38

12 E. Devonwood, Romeoville, IL 60446 USA; 815-293-0772; Fax: 815-293-0820; Dennis Rollingier, CEO, info@radiomet.com; www.radiomet.com



Radius Power, Inc. 65

1751 N. Batavia St., Orange, CA 92865 USA; 714-289-0055; Fax: 714-289-2149; George Wells, Sales Manager, georgew@radiuspower.com; www.radiuspower.com

Rainford EMC Systems Ltd.

North Florida Road, Haydock St., Helens, Merseyside GA WA11 9TN, United Kingdom; +44 1942 296 190; Fax: +44 1942 275 202; bill.mcfadden@rainfordemc.com; www.rainfordemc.com

Ramsey Electronics

590 Fishers Station Drive, Victor, NY 14564 USA; 585-924-4560; Fax: 585-924-4555; brian@ramseyelectronics.com; www.ramseytest.com

Remcom Inc.

315 S. Allen St., Suite 222, State College, PA 1680 USA; 814-861-1299; 888-773-6266; slucas@remcom.com; www.remcom.com

Restor Metrology

921 Venture Ave., Leesburg, FL 34748 USA; 877-220-5554; 888-886-0585; eric.egler@restormetrology.com; www.restormetrology.com



RETLIF TESTING LABORATORIES

Retlif Testing Laboratories..... 33

795 Marconi Ave., Ronkonkoma, NY 11779 USA; 631-737-1500; Fax: 631-737-1497; Walter A. Poggi, sales@retlif.com; www.retlif.com

CT Danielson, Mantec, Inc./Peter Mann	860-774-1551
DC Washington, Retlif	703-533-1614
NC Charlotte, Retlif	704-909-2840
NH Goffstown, Retlif	603-497-4600
PA Harleysville, Retlif	215-256-4133

RF Exposure Lab, LLC

2867 Progress Pl., Escondido, CA 92029-1531 USA; 760-737-3131; Fax: 760-737-9131; www.rfexposurelab.com

RF Immunity Ltd.

2.Prat St., Yavne 81227, Israel; 972-73-2331300; Fax: 972-73-2331325; Haim Kalfon, Managing Director, haimk@rfimmunity.co.il; www.rfimmunity.com

RFI Controls Company

340 Village Lane, Los Gatos, CA 95030 USA; 408-399-7007; Fax: 408-399-7011; jessica.hayes@rficontrols.com; www.rficontrols.com

RFI Corp. 60

100 Pine Aire Drive, Bay Shore, NY 11706-1107 USA; 631-234-6400; Fax: 631-234-6465; ilashinsky@rficorp.com; www.rficorp.com

RFI Global Services Ltd.

Pavilion A, Ashwood Park, Ashwood Way, Basingstoke, Hampshire, RG23 8BG United Kingdom; +44 (0)1256 312000; Fax: +44 (0)1256 312001; www.rfi-global.com

RFTEK

5103 Duntrune Court, Raleigh, NC 27606 USA; 919-622-4088; dguzman@rftek.net; www.rftek.net

Rhein Tech Laboratories, Inc.

360 Herndon Parkway, Suite 1400, Herndon, VA 20170 USA; 703-689-0368; Fax: 703-689-2056; sgrandy@rheintech.com; www.rheintech.com

RIA CONNECT

200 Tornillo Way, Tinton Falls, NJ 07712 USA; 732-389-1300; 888-722-5625; Fax: 732-389-9066; donna@riacconnect.com; www.riacconnect.com

Rittal Corp.

1 Rittal Place, Urbana, OH 43078 USA; 937-399-0500; 1-800-477-4000; Fax: 937-390-5599; mcorcoran@rittal-corp.com; www.rittal-corp.com

RMV Technology Group, LLC

NASA Research Park Bldg. 19, Suite 2030, MS 19-46C, Moffett Field, CA 94517 USA; 650-964-4792 650-964-1268; bob@esdrmv.com; www.esdrmv.com

Rogers Labs, Inc.

4405 West 259th Terrace, Louisburg, KS 66053 USA; 913 837-3214; Fax: 913 837-3214; rogers@pixius.net; www.rogerslabs.com

Rohde & Schwarz, Inc.

8661 Robert Fulton Dr # A, Columbia MD 21046-2265 USA; 410-910-7944; Kim Trompeter, Kim.Trompeter@rsa.rohde-schwarz.com; www.rohde-schwarz.us

Roxburgh EMC

Deltron Emcon House, Hargreaves Way, Sawcliffe Industrial Park, Scunthorpe, North Lincolnshire, DN15 8RF, United Kingdom; +44 1724 273205; Fax: +44 1724 280353; www.dem-uk.com/roxburgh

Roxtec

10127 E. Admiral Place, Tulsa, OK 74116 USA; 918-254-9872; 800-520-4769; Fax: 918-254-2544; michael.budde@us.roxtec.com; www.roxtec.com

RTP Company

580 E. Front St., Winona, MN 55987 USA; 507-454-6900; Fax: 507-454-2041; Kirk Fratzke, Advtg and Promotions, rtp@rtppcompany.com; www.rtpcompany.com/

Rubbercraft

15627 South Broadway, Gardena, CA 90248 USA; 310-328-5402; Fax: 310-618-1832; mchian@rubbercraft.com; www.rubbercraft.com

Rubicom Systems, A division of ACS

284 West Drive, Melbourne, FL 32904 USA; 321-951-1710; jgerke@rubicomtestlab.com; www.rubicomtestlab.com

S

Sabritec

17550 Gillette Ave., Irvine, CA 92614 USA; 949-250-1244; Fax: 949-250-1009; sdurr@sabritec.com; www.sabritec.com

SAE Power

1500 E Hamilton Ave Ste 118, Campbell, CA 95008; www.sae-power.com/emirfi-filter-products

Saelig Company

1160-D2 Pittsford-Victor Road, Pittsford, NY 14534 USA; 888-772-3544; Fax: 585-385-1768; alan.lowne@saelig.com; www.saelig.com

Safe Engineering Services & Technologies

3055 Boul. des Oiseaux, Laval, Quebec H7L 6E8, Canada -6071; 1-800-668-3737; Fax: 1-800-668-6124; Carmela.Sabelli@sestech.com; www.sestech.com

Safety Test Technology Co., Ltd

Pu Tian Science Park B415, 28 Xin Jie Kou Wai Da Jie, Xicheng District, Beijing, 100088 P.R. China; 86-10-51654077; www.instrument.com.cn

Saint-Gobain High Performance Seals

7301 Orangewood Ave., Garden Grove, CA 92841-1411 USA; 1-800-544-0080; donald.m.munro@saint-gobain.com; www.omnishield.saint-gobain.com

SAS Industries, Inc.

939 Wading River Manor Road, Manorville, NY 11949 USA; 631-727-1441 ext. 302; Fax: 631-727-1387; msteckis@sasindustries.com; www.sasindustries.com



Schaffner EMC, Inc. 57

52 Mayfield Ave., Edison, NJ 08837 USA; 800-367-5566; Fax: 732-225-4789; Ken Bellero, ken.bellero@schaffner.com; www.schaffnerusa.com

AL Aurora-Tech Marketing	800-955-1970
AZ Schaffner West/Carl Martens	928-443-7650
CA O'Donnell Associates North/San Jose	408-456-2950
CA Conquest Technical Sales/LA/Orange Country	805-241-5118
CA Admor Technical Sales/San Diego	760-522-4140
CO Schaffner West/Carl Martens	928-443-7650
CT Norris Associates Inc.	781-749-5088
FL Sunland Associates	407-365-9533
GA Aurora-Tech Marketing	800-955-1970
IA Connector Technology LLC (CTEC)	636-561-3543
ID WESCO Sales Group, Inc.	425-941-6681
IL Connector Technology LLC (CTEC)/South IL	636-561-3543
IL Brainard-Nielsen Marketing Inc./N. IL	847-734-8400
IN Allied Enterprises, Inc.	440-808-8760
KS Connector Technology LLC (CTEC)	636-561-3543
KY Allied Enterprises, Inc.	440-808-8760
MA Norris Associates Inc.	781-749-5088
ME Norris Associates Inc.	781-749-5088
MI Allied Enterprises, Inc.	440-808-8760
MN Rockford Controls of Minnesota	763-557-2801
MO Connector Technology LLC (CTEC)	636-561-3543
MS Aurora-Tech Marketing	800-955-1970
NC Aurora-Tech Marketing	800-955-1970
ND Rockford Controls of Minnesota	763-557-2801
NE Connector Technology LLC (CTEC)	636-561-3543

NH Norris Associates Inc.	781-749-5088
NY Net Sales Inc.	585-924-1844
OH Allied Enterprises, Inc.	440-808-8760
OR WESCO Sales Group, Inc.	425-941-6681
PA Allied Enterprises, Inc./W.PA.	440-808-8760
PA Colrud Lowery	610-566-6686
RI Norris Associates Inc.	781-749-5088
SD Rockford Controls of Minnesota	763-557-2801
TN Aurora-Tech Marketing	800-955-1970
TX Kruvand	972-437-3355
VA Allied Enterprises, Inc.	440-808-8760
VT Norris Associates Inc.	781-749-5088
WA WESCO Sales Group, Inc.	425-941-6681
WY Meridian Marketing	303-790-7171

INTERNATIONAL

BRA Sao Paulo , LC Overdata Representação e Comércio Exterior Ltda.	+55-11-2842-6842
CAN West Coast/Carl Martens	928-443-7650
Brampton, E-Cubed Components, Inc/Michael Wheeler	905-791-0812
MEX Kruvand de Mexico	01152-33-3671-4159

Schlegel Electronic Materials

806 Linden Ave., Rochester, NY 14602 USA; 905-893-3241; Fax: 905-893-5623; lee.masucci@schlegelemi.com; www.schlegelemi.com



ELECTRONIC COMPONENTS

Schurter, Inc. 63

447 Aviation Blvd., Santa Rosa, CA 95403 USA; 707-636-3000; Fax: 707-636-3033; Marjorie Tibbs, info@schurterinc.com; www.schurterinc.com

SDP Engineering Inc.

17 Spectrum Pointe, P.O. Box #508, Lake Forest, CA 92630 USA; 949-588-7568; Fax: 949-588-8871; don@sdpengeering.com; www.sdpengineering.com

Seal Science

Seal Science West: 17131 Daimler St., Irvine, CA 92614 USA; 949-253-3130; Fax: 949-253-3141; westernsales@sealscience.com; Seal Science East: 1160 Win Drive, Bethlehem, PA 18017-0759; 610-868-2800; Fax: 610-868-2144; easternsales@sealscience.com; www.sealscience.com

Sealcon

14853 E. Hinsdale Ave., Suite D, Centennial, CO 80112-4240 USA; 303-699-1135; info@sealconusa.com; www.sealconusa.com

Sealing Devices Inc.

4400 Walden Ave., Lancaster, NY 14228 USA; 716-684-7600; 800-727-3257; Fax: 716-684-0760; deberhardt@sealingdevices.com; www.sealingdevices.com

Seibersdorf Laboratories

Seibersdorf, 2444, Austria; +43 50550 2803; Fax: +43 50550 2881; wolfgang.muellner@seibersdorf-laboratories.at; www.seibersdorf-laboratories.at

Select Fabricators Inc.

5310 North Str. Bldg. 5, P.O. Box 119, Canandaigua, NY 14424-0119 USA; 585-393-0650; 888-599-6113; Fax: 585-393-1378; Dan Ramich & Brian Smith; contactus@select-fabricators.com; www.select-fabricators.com

Sensor Products Inc.

300 Madison Ave., Madison, NJ 07940 USA; 973-884-1755; 800-755-2201; Fax: 973-884-1699; dlandau@sensorprod.com; www.sensorprod.com

Seven Mountains Scientific, Inc. (ENR) 81

913 Tressler St., P.O. Box 650, Boalsburg, PA 16827 USA; 814-466-6559; Fax: 814-466-2777; tom@7ms.com

SGS

201 Route 17, North Rutherford, NJ 07070 USA; 201-508-3188; Fax: 201-935-4555; maureen.plowman@sgs.com; www.ee.sgs.com

Shanghai Empek Electromagnetic Technology

No.78 Caobao Road, Shanghai, China; +86 21 62477218 62477258; Fax: +86 21 62475839; vtexpo@online.sh.cn; www.emexpo.com

Shielding Resources Group, Inc.

9512 E. 55th St., Tulsa, OK 74145; 918-663-1985; Fax: 918-663-1986; www.shieldingresources.com

SIEMIC

775 Montague Expressway, Milpitas, CA 95035 USA; 408-526-1188; Fax: 408-526-1088; Mike Driggers, mike.driggers@siemic.com; www.SIEMIC.com

Silicon Labs

400 W. Cesar Chavez, Austin, TX 78701 USA; 512-416-8500; Fax: 512-416-9669; susan.nayak@silabs.com; www.silabs.com

Silicone Solutions

1670-C Enterprise Pkwy., Twinsburg, OH 44087 USA; 330-405-4595; Fax: 330-405-4596; www.siliconesolutions.com

SILENT Solutions

10 Northern Blvd., Suite 1, Amherst, NH 03031 USA; 603-578-1842; LeeHillSilent@gmail.com; www.silent-solutions.com

Simberian Inc.

2326 E. Denny Way, Seattle, WA 98122 USA; 702-876-2882; shlepnev@simberian.com; www.simberian.com

SimLab Software GmbH

Bad Nauheimer Str. 19, 64289 Darmstadt, Germany; 49 6151 7303-0; Fax: +49 6151 7303-100; schrack@simlab.de; www.cst.com

SiTime Corp.

990 Almaror Ave., Sunnyvale CA 94085 USA; 408-328-4400; Fax: 408-328-4439; Information & Support, info@sitime.com; www.sitime.com

Solar Electronics Co.

10866 Chandler Blvd., North Hollywood, CA 91601 USA; 818 755-1700; 800-952-5302; Fax: 818 755-0078; tom@theparkerpress.com; www.solar-emc.com

Soliani EMC SRL

Via Varesina 122, 22100 Como Lombardia, Italy; +39-031-5001112; Fax: + 39-031-505467; info@solianiemc.com; www.solianiemc.com

Sonnet Software, Inc.

100 Elwood Davis Road, N. Syracuse, NY 13212 USA; 315-453-3096; 1-877-7SONNET; Fax: 315-451-1694; calton@sonnetsoftware.com; www.sonnetsoftware.com

Soshin Electronics Europe GmbH

Westerbachstrasse 32, c/o NGK Europe GmbH, Kronberg, Taunus D-61476, Germany; 49-6173-993108; Fax: +49-6173-993206; tkhayashi@soshin.co.jp; www.soshin-ele.com/

Southwest Microwave, Inc.

9055 South McKemy St., Tempe, AZ 85284; 480-783-0201; www.southwestmicrowave.com

Southwest Research Institute

6220 Culebra Road, P.O. Drawer 28510, San Antonio, TX 78228; 210-684-5111; www.swri.com

Spec-Hardened Systems

110 Larkwood Drive, Rochester, NY 14625-4270 USA; 585-225-2857; Fax: 585-225-2857; shsec@aol.com; members.aol.com/shsec.myhomepage/index.html

Source1 Solutions

4675 Burr Drive, Liverpool, NY 13088 USA; 315-730-5667; Fax: 315-457-0428; Steve Frierson, sf@source1compliance.com; www.source1compliance.com

Souriau PA&E

434 Olds Station Road, Wenatchee, WA 98801 USA; 509-664-8000; Fax: 509-663-5039; rkalkowski@pacaero.com; www.pacaero.com

SPAWAR Systems Center Atlantic

P.O. Box 190022, North Charleston, SC 29419-9022 USA; 843-218-5723; Fax: 843-218-4238; www.public.navy.mil/spawar/Atlantic/Pages/AboutUs.aspx

Spec-Hardened Systems

119 Larkwood Drive, Rochester, NY 14626-4270 USA; (585) 225-2857; Fax: (585) 225 2857; Anthony A. DiBiase, shsec@aol.com

Specialty Silicone Products

3 McCreia Hill Road, Ballston Spa, NY 12020 USA; 518-885-8826; 800-437-1442; Fax: 518-885-4682; astiles@sspinc.com; www.sspinc.com



Spectrum Advanced Specialty Products 71

8061 Avonia Road, Fairview, PA 16415 USA; 814-474-1571; Fax: 814-474-3110; Kerri Fabin, Director of Sales & Marketing – EMI, Filt susan@altman-hall.com; www.specemc.com

AL	Huntsville, GWA-Alt/Hsv	256-882-6751
AZ	Tempe, Westrep	480-820-9932
	Queen Creek, W. Reg. Sales Office/Jim Devere	866-281-0903
CA	Anaheim, Westrep	714-527-2822
	Los Altos, Recht	650-964-6321
CO	Centennial, W. Howard Associates	303-766-5755
FL	Hutchinson Island, FLA Technology Sales	954-802-2385
	Lake Mary, SE Reg Sales/Jason Russolose	866-565-6226
IA	Cedar Rapids, MidTech	219-395-0028
IN	Indianapolis, Dytec, Inc.	317-578-0474
	Indianapolis, Alliance Mfg. (Automotive)	317-575-4600
MA	Woburn, Kitchin & Kutchin	781-782-0700
MD	Columbia, Mechtronics Sales	410-309-9600
MN	S. St. Paul, North Port Engineering	651-457-8000
NC	Raleigh, EMA (Electronic Marketing Association)	919-847-8800
NJ	Fairfield, TAM (Technical Applications & Marketing)	973-575-4130
NY	E. Syracuse, Leonard D. Allen	315-431-1001
PA	Elizabethtown, NE Reg Sales/Jeff Showers	866-281-0988
TX	Richardson, Pro-Comp Sls.	817-912-3750
	El Paso, World Class Marketing	915-585-3228
WA	Redmond, Haleo, Inc.	425-497-8500
INTERNATIONAL		
CAN	ON, Canadian Source Corp.	905-415-1951
DEU	Schwabach, European Sales	49-9122-7950
MEX	Guadalajara, Marfil	011-52-33-3670



Spira Manufacturing Corp. 87

12721 Saticoy St. South, N. Hollywood, CA 91605 USA; 818 764-8222; Fax: 818-764-9880; Wendy Kunkel, wendy@spira-emi.com; www.spira-emi.com

AZ	Tucson, Synergistic Technology Group	520-760-0291
CA	RC Products	510-440-0500
CA	San Diego, Altamont Tech. Serv.	858-733-0618
DC	Carwithen Associates	410-549-3335
MD	Mt. Airy, Carwithen Associates Inc.	410-549-3335
NM	Synergistic Technology Group	520-760-0291
NV	North, RC Products	510-440-0500
NV	South, Synergistic Technology Group	520-760-0291
VA	Carwithen Associates	410-549-3335

INTERNATIONAL

AUT	Tricom Mikrowellen GMBH	49-8161-86066
CHE	Tricom Mikrowellen GMBH	49-8161-86066
CHN	USA Contact, IES Technologies Inc.	630-632-5941
DEU	Tricom Mikrowellen GMBH	49-8161-86066
FRA	Getelec	33-146-44-68-91
ISR	Silram Ltd.	972-9-767-1332
JPN	Intermark Co., Ltd.	81-587-34-3761

Sprinkler Innovations

95 Ledge Road, Suite 4, Seabrook, NH 03874 USA; 800-850-6692; Fax: 603-468-1031; jbeers@sprinklerinnovations.com

SRICO, Inc.

2724 Sawbury Blvd., Columbus, OH 43235; 614-799-0664; Fax: 614-799-2116; sr@srico.com; www.srico.com

Stahlin Enclosures

500 Maple St., Belding, MI 48809 USA; 616-794-0700; Fax: 330-725-7265; tramirez@stahlin.com; www.stahlin.com

Stephen Halperin & Associates Ltd.

1072 Tower Lane, Bensenville, IL 60106 USA; 630-238-8883; Fax: 630-238-9717; info@halperinassoc.com; www.halperinassoc.com

Stockwell Elastomers, Inc.

4749 Tolbut St., Philadelphia, PA 19136 USA; 215-335-3005; Fax: 215-335-9433; www.stockwell.com

Stork Garwood Laboratories Inc.

7829 Industry Ave., Pico Rivera, CA 90660 USA; 562-949-2727; Fax: 562-949-8757; info.garwood@us.stork.com; www.storksmt.com

Sulzer Metco (Canada) Inc.

10108 114 Str., Fort Saskatchewan, Alberta T8L 4R1, Canada; 780-992-5280; 1-877-440-7941; Fax: 780-992-5275; wendy.tetz@sulzer.com; www.conductivefillers.com

Sunkyoung S.T.

Hwaseong-Si Gyeonggi-Do, Korea; 82-31-351-8171; www.sunkyoungst.com

Sunol Sciences Corp.

6780 Sierra Court, Suite R, Dublin, CA 94568 USA; 925-833-9936; Fax: 925-833-9059; stu@sunolsciences.com; www.sunolsciences.com

Suppression Devices

Unit 8, York Street Business Centre, Clitheroe, Lancashire BB7 4TQ, United Kingdom; 44 (0)1200 444497; Fax: + 44 (0)1200 444330; sales@suppression-devices.com; www.suppression-devices.com/

Suzhou 3CTEST Electronic Co., Ltd.

2th Anda Park, No.198 Jinshan Road, Suzhou Jiangsu 215011, China; +86-512-68413700; +86-512-68077661; Fax: 0512-68079795; sales@3ctest.cn www.3ctest.cn

Swift Textile Metalizing LLC 88

P.O. Box 66, Bloomfield, CT 06002 USA; 860-243-1122; Fax: 860-243-0848; Christen Holmberg, Product Manager, cholmberg@swift-textile.com; www.swift-textile.com



Syfer Technology Limited 62

Old Stoke Road, Arminghall, Norwich NR14 8SQ, United Kingdom; +44 1603 723310; Fax: +44 1603 723301; Chris Noade, cnoade@syfer.co.uk; www.syfer.com

Synergistic Technology Group, Inc.

8987 E Tanque Verde Road 292B, Tucson, AZ 85749 USA; 520-760-0291; Fax: 520-760-3361; Tom Venable, tvenable@dakotacom.net; www.e-SynergisticTech.com

Sypris Test and Measurement

6120 Hasting Moss Road, Orlando, FL 32807 USA; 800-839-4959; Fax: 407-678-0578; Kelly.Radziski@Sypris.com; www.wetest.com

Syscom Advanced Materials

1275 Kinnear Rd. Columbus OH 43212 USA; (614)487.3626; Fax: (614)487.3631; Jeff Martin, info@metalcladfibers.com; www.metalcladfibers.com

T

Tapecon, Inc.

701 Seneca Street, Suite 255, Buffalo, NY 14210 USA; 800-333-2407; Fax: 716-854-1320; www.tapecon.com

Taiyo Yuden (U.S.A.) Inc.

1930 N. Thoreau Drive, Suite 190, Schaumburg, IL 60173 USA; 847-925-0888; 800-350-6800; Fax: 847-925-0899; sales@t-yude.com; www.t-yuden.com

TDK Corp.

1221 Business Center Drive, Mount Prospect, IL 60056 USA; 847-803-6100; Fax: 847-803-1125; sreynoso@tdkca.com; www.tdk.com



TDK-EPC Corp. 59

485B Route 1 South, Suite 200, Iselin, NJ 08830 USA; 800-888-7729; Fax: 732-603-5978; Joe Pulomena, Director of Marketing/ferrites/inductors, Joseph.Pulomena@epcos.com; www.epcos.com/emc

TDK-Lambda Americas

High Power Division, 405 Essex Road, Neptune, NJ 07783 USA; 732-922-9300; Fax: 732-922-9334; www.us.tdk-lambda.com/hp

TDK RF Solutions, Inc.

1101 Cypress Creek Road, Cedar Park, TX 78613 USA; 512-258-9478; Fax: 512-258-0740; Chris Whalen, info@tdkrf.com; www.tdkrfsolutions.com

Tech-Etch

Tech-Etch, Inc. 92

45 Aldrin Road, Plymouth, MA 02360 USA; 508-747-0300, ext. 3050; Fax: 508-746-9639; Bruce McAllister, bmcallister@tech-etich.com; www.tech-etich.com

AL	Huntsville, Cornerstone Sales, LLC	256-430-8000
AZ	Chandler, Moss Marketing	602-828-1461
CA	Brea, Motion Components	714-255-1080
	Mountain View, Ross Marketing	650-691-0119
CO	Lakewood, Moss Marketing	800-980-8812
DC	Ellicott City, Eastern Tech Corp.	410-715-2100
FL	Oviedo, Cornerstone Sales, LLC	321-765-4862
	Palm Harbor, Cornerstone Sales, LLC	727-789-4802
GA	Duluth, Cornerstone Sales, LLC	770-638-8998
IL	Barrington, EMT Engineering Sales	847-481-7403
KS	Lenexa, Midtec Associates, Inc.	913-541-0505
MA	Carver, Connors Co., Inc.	508-866-5392
MD	Ellicott City, Eastern Tech Corp.	410-715-2100
ME	Carver, MA Connors Co., Inc.	508-866-5392

MI	Kettering, OH, Frederic Ohmer & Associates	937-434-1454
MN	Burnsville, EMT Engineering Sls.	952-888-1020
MO	Florissant, Midtec Associates, Inc.	314 839-3600
NC	Raleigh, Cornerstone Sales, LLC	919-834-2677
NH	Carver, MA, Connors Co., Inc.	508-866-5392
NJ	Holgate, Brandon Associates, Inc.	610-738-8500

NY	Canandaigua, Brandon Associates, Inc.	610-738-8500
	Central Square, Brandon Associates, Inc.	610-738-8500
	Commack, Brandon Associates, Inc.	610-738-8500
OH	Kettering, Frederic Ohmer & Assoc	937-434-1454
OR	Beaverton, Technical Marketing, Inc.	503-627-9000
PA	West Chester, Brandon Associates, Inc.	610-738-8500
	Bellefonte, Brandon Associates, Inc.	610-738-8500
SC	Raleigh, NC, Cornerstone Sales, LLC	919-834-2677
TN	Eastern, Duluth, GA, Cornerstone Sales, LLC	770-638-8998

	Western, Huntsville, AL Cornerstone Sales, LLC	256-430-8000
TX	Colleyville, Centramark	817-498-5818
	Garland, Centramark	972-414-8188
	Austin, Centramark	512-795-0966
	Bellaire, Centramark	713-771-1500
UT	Salt Lake City, Moss Marketing	801-947-0169
VA	Ellicott City, MD, Eastern Tech Corp	410-715-2100
WA	Kirkland, Technical Marketing, Inc.	425-739-4600
	Spokane, Technical Marketing, Inc.	509-481-5715
WI	Mequon, EMT Engineering Sales	262-236-4001
WY	Lakewood, CO, Moss Marketing	800-980-8812

	INTERNATIONAL	
BEL	HF Technology	3175-6283717
CAN	Dollard des Ormeaux, The ID Group Inc	514-575-8044
CHN	Beijing, Mindar China Co. LTD.	8610 64680338
DEU	Berlin, Feuerherdt GmbH	4930710964553
DNK	Gydevang, Bomberg EMC Products	454 814 0155
FRA	Les Ulis, Yelloz Components	330164466968
GBR	Rochdale, TBA Electro Conductive Products	441706 647718
ISR	Rishon Le-Zion, Maham Fasteners	972 3 9626516
ITA	Sircos/Italy	390255231395
JPN	Tokyo, Taiyo Wire Cloth Co.	81334937051
NOR	Oslo, EG Components	472-325-4600
PRK	Eretec	82-31-436-1100
SGP	Ayer Raja Industrial Estate, Glocom Marketing PTE, LTD	65 6873 0933
TWN	Taipei Hsien, TennMax, Inc.	886226954137
SAF	Linbro Park, Actum Electronics	27 11 608 3001

Teledyne Reynolds

Navigation House, Canal View Road, Newbury, Berkshire, RG14 5UR United Kingdom; +44(0)1635262231; Fax: +44(0)1635521936; gfagg@teledyne.com; www.teledynereynolds.co.uk

TEMPEST Inc.

11654 Plaza America Drive, P.O. Box #134, Reston, VA 20190 USA; 03-836-7378; www.tempest-inc.com

Tempest Security Systems Inc.

P.O. Box 584, Troy, OH 45373 USA; 937-335-5600; Fax: 937-335-0018; ianwaterman00@aol.com; www.tempesta.com

TESEO

Corso Alexander Fleming 27, Druento, Torino 10040 Italia; +39 011 9941 911; Fax: +39 011 9941 900; sales@teseo.net; www.teseo.net

Teseq 21

52	Mayfield Ave., Edison, NJ 08837 USA; 732-417-0501; Fax: 732-417-0511; Mary Jane Salvador, Sales Contact, maryjane.salvador@teseq.com; www.teseq.com	
CA	Universal Components	949-707-0407
NY	PMR, Inc.	631-244-1420
NY	L-MAR Assdciates	585-899-3920
OH	Electronic Salesmasters	216-831-9555
PA	Keystone Sales & Marketing	610-745-7237
TX	Biggs and Associates	972-679-5871
	INTERNATIONAL	
CAN	National Power and Signal	519-763-4225
IND	Trinity Technologies	91-80-25719382
POL	SEEN Distribution	48-22-625-1225
	SYSTEM elementy elektroniczne	48 56 67 87 000
TUR	Kilia Teknoloji	90 212 3439055

Test & Measurement Australia Pty Limited

P.O. Box 197, Blaxland, NSW 2774 Australia; 61 2 4739 9523; 1-800-888-523; Fax: +61 2 4739 9524; info@TandM.com.au; www.TandM.com.au

Test Equipment Connection

30 Skyline Drive, Lake Mary, FL 32746 USA; 407-804-1299; 800-615-8378; business@testequipmentconnection.com; www.testequipmentconnection.com

Test Site Services

30 Birch St., Milford, MA 01757 USA; 508-962-1662; Fax: 508-634-0388; Richard Wiedeman, slp5@verizon.net; testsiteservices.com

Texas Spectrum Electronics

120 Regency, Wylie, TX 75098 USA; 972-296-3699; Fax: 972-296-7881; TSEinfo@texasspectrum.com; www.texasspectrum.com

The Compliance Management Group

202 Forest St., Marlborough, MA 01752 USA; 508-281-5985; Fax: 508-281-5972; ewilbur@cmgcorp.net; www.cmgcorp.net

THEMIX Plastics, Inc.

621-D East Lake St., Lake Mills, WI 53551 USA; 1-920-945-0599; 1-888-234-3304; Fax: 1-920-945-0596; steven@THEMIXplastics.com; www.THEMIXplastics.com

Thermo Fisher Scientific

200 Research Drive, Wilmington, MA 01887 USA; 978-935-0800; Fax: 978-275-0850; ron.ahlquist@thermofisher.com; www.thermoscientific.com/esd

THORA Elektronik GmbH

Esbacher Weg 13, D-91555 Feucht, Germany; 0049-9825-92800; Fax: 0 98 52 6 10 79-50; service@thora.com; www.thora.com

Timco Engineering, Inc.

849 NW State Road, P.O. Box 45 370, Newberry, FL 32669 USA; 352-472-5500; 888-472-2424; Fax: 352-472-2030; shoffman@timcoengr.com; www.timcoengr.com

TMD Technologies Ltd.

Swallowfield Way, Hayes, Middlesex UB3 1DQ, United Kingdom; +44-20-8573-5555; Fax: +44-20-8569-1839; heather.skinner@tmd.co.uk; www.tmd.co.uk

TRaC Global

100 Frobisher Business Park, Leigh Sinton Road, Worcestershire WR14 1BX, United Kingdom; +44 (0) 1684 571700; Bally,Wadialia@tracglobal.com; www.trac-ktl.com/emc-testing.html

Transient Specialists, Inc.

7704 S. Grant St., Burr Ridge, IL 60527 USA; 866-EMI-RENT; 630-887-0329; www.transientspecialists.com

Transtector Systems Inc.

10701 N. Airport Road, Hayden, ID 83835 USA; 208-762-6113; Fax: 208 762 6133; ljohanson@transtector.com; www.transtector.com

Tranzeo EMC Labs Inc.

19473 Fraser Way, Pitt Meadows, British Columbia V3Y 2V4, Canada; 604-460-4453; Fax: 604-460-6005; djohanson@tranzeo-emc.com; www.tranzeo-emc.com

TREK, Inc.

11601 Maple Ridge Road, Medina, NY 14103 USA; 585-798-3140; Fax: 585-798-3106; Brian Carmer, sales@trekinc.com; www.trekinc.com

Trional Corp.

1465 Walli Strasse Drive, Burton, MI 48509 USA; 810-341-7931; 1-800-847-8111; pkrug@trional.com; www.trional.com/test_engineering.html

Tri-Mag, Inc. 73

1601 Clancy Court, Visalia, CA 93291 USA; 559-651-2222; Fax: 559-651-0188; Jia-Ming Li, jmli@tri-mag.com; sales@tri-mag.com; www.tri-mag.com

TUV Rheinland of North America

12 Commerce Road, Newtown, CT 6470 USA; 203-426-0888; Fax: 203-426-4009; Bruce Fagley, bfagley@us.tuv.com; www.tuv.com



America

TUV SUD America Inc.

1775 Old Highway 8 NW, Suite #104, New Brighton, MN 55112; 651-631-2487 or go to www.TUVamerica.com; Fax 651-638-0285; info@tuvam.com; www.TUVamerica.com

TUV SUD Product Service Ltd.

Octagon House, Concorde Way Segensworth North Fareham Hampshire PO15 5RL United Kingdom; +44 (0) 1489 558100; Fax: +44 (0) 1489 558101; Robert Greenwood, info@tuvps.co.uk; www.tuvps.co.uk

TUV SUD Senton GmbH

Außere Frühlingstraße 45, Straubing 94315 Germany; +49-9421-5522-22; Fax: +49-89-5155-1813; Stefan Kammerl, stefan.kammerl@tuev-sued.de; www.tuev-sued.de/senton

TWP Inc.

2831 Tenth St., Berkeley, CA 94710 USA; 510-548-4434; 800-227-1570; Fax: 510-548-3073; g@twpinc.com; www.twpinc.com

Tyco Electronics

620 S. Butterfield Road, Mundelein, IL 60060 USA; 847-573-6508; bob.fawley@tycoelectronics.com

U

Ultratech Group of Labs

3000 Bristol Circle, Oakville, Ontario L6H 6G4, Canada; 905-829-1570; vic@ultratech-labs.com; www.ultratech-labs.com

Underwriter's Laboratories Inc.

333 Pflingsten Road, Northbrook, IL 60062-2096 USA; 847-272-8800; Fax: 847-272-8129; www.ul.com/hitech/emc

United Seal and Rubber Co., Inc.

7025-C Amwiler Ind. Drive, Atlanta, GA; 770-864-0532; Fax: 770-729-8992; sales@unitedseal.com; www.unitedseal.com

United Western Enterprises, Inc

850 Flynn Road, Camarillo, CA 93012 USA; 800-964-6461; Fax: 805-389-1167; George Ferkin, gferkin@uweinc.com; www.uweinc.com

Universal Air Filter

1624 Sauguet Industrial Parkway, P.O. Box 5006, Sauguet, IL 62206 USA; 618-271-7300; 800-541-3478; Fax: 618-271-8808; mikemiano@uaf.com; www.uaf.com

Universal Shielding Corp.

20 West Jefryn Boulevard, Deer Park NY 11729 USA; 631-667-7900; Fax: 631-667-7912; Irwin Newman, info@universalshielding.com; universalshielding.com

V

V-Comm, LLC

2540 US Highway 130, Suite 101, Cranbury, NJ 08512; 609-655-1200; Fax: 609-409-1927; www.vcomm-eng.com

V Technical Textiles, Inc.

4502 Route 31, Palmyra, NY 14522 USA; 315-597-1674; Fax: 315-597-6687; whoge@rochester.rr.com; www.shieldextrading.net

Vacuum Schmelze GmbH & CO. KG

Grüner Weg 37, D-63450 Hanau, Germany; +49 6181 380; Fax: +49 6181 38-2645; info@vacuumschmelze.com; www.vacuumschmelze.com

ValueTronics International, Inc.

1675 Cambridge Drive, Elgin, IL 60123 USA; 800-552-8258; 847-717-6121; Sales Manager, sales@valuetronics.com; www.valuetronics.com

Vanguard Products Corp.

87 Newtown Road, Danbury, CT 06810 USA; 203-744-7265; Fax: 203-798-2351; mhansen@vanguardproducts.com; www.vanguardproducts.com

Venture Tape Corp.

30 Commerce Road, P.O. Box 384, Rockland, MA 02370 USA; 781-331-5900; 800-343-1076; Fax: 781-871-0065; mnorton@venturetape.com; www.venturetape.com

Vermillion, Inc.

4754 South Palisade, Wichita, KS 67217 USA; 316-524-3100; fhunt@vermillioninc.com; www.vermillioninc.com

Videon Central, Inc.

2171 Sandy Drive, State College, PA 16803 USA; 814-235-1111 Ext 370; Fax: 814-235-1118; Les Bennett, les@videon-central.com; www.videon-central.com

View Thru Technologies, Inc.

1765 Walnut Lane , Quakertown ,PA 18951 USA; 215-703-0950; Fax: 215-703-0952; jeffreid@viewthru.net; www.viewthru.net

Vishay Intertechnology, Inc.

63 Lancaster Ave. (HQ), Malvern, PA 19355 USA; 610-644-1300; joan.lordan@vishay.com; www.vishay.com

Visron Design, Inc.

150 Lucius Gordon Drive, Suite 111, West Henrietta, NY 14586 USA; 585-292-5780; Fax: 585-292-5787; www.visron.com

VitaTech Electromagnetics

115 Juliad Ct. Suite 105, Fredericksburg, VA 22406 USA; 540-286-1984; Fax: 540-286-1865; Christina Vitale, cvitale@vitatech.net, vitatech.net

Voltech Instruments, Inc.

Didcot, NY; 585-292-5780; www.voltech.com

VPT, Inc.

11314 4th Ave. West, Suite 206, Everett, WA 98204 USA; 425-353-3010; Fax: 425-353-4030; michelle@mm-communications.com; www.vpt-inc.com

VTI Vacuum Technologies Inc.109

1215 Industrial Ave., Reedsburg, WI 53959 USA; 608-524-9822; Fax: 608-524-9722 ; www.vactecinc.com

W

Walshire Labs, LLC

8545 126th Ave., N. Largo, FL 33773 USA; 727-530-8637; www.walshirelabs.com

Washington Laboratories, Ltd.

7560 Lindbergh Drive, Gaithersburg, MD 20879 USA; 301-417-0220; Fax: 301-417-9069; mikev@wll.com; www.wll.com

Wavecontrol

Pallars, 65-71 Barcelona, 8018 Spain; +34 933208055; Fax: +34 933208056; ernestcid@wavecontrol.com; www.wavecontrol.com

WaveZero, Inc.

818 Kifer Road, Sunnyvale, CA 94086 USA; 408-830-5100; Fax: 408-773-8480; www.wavezero.com

WEMS Electronics

4650 W. Rosecrans Ave., Hawthorne, CA 90250-6898 USA; 310-644-0251 ext. 176; Fax: 310-644-5334; John O'Brien, Marketing Manager, jobrien@wems.com; www.wems.com

White Sands Missile Range

TEDT-WSV-EE WSMR NM 88002-5158 USA; 575-678-6107; Fax: 575-678-3999; stephanie.jesson@us.army.mil; www.wsmr.army.mil/

Wilcoxon Research

20511 Seneca Meadows Parkway, Germantown ,MD 20876 USA; 301-330-8811; 800-WILCOXON; Fax: 301-330-8873; www.wilcoxon.com

Willow Run Test Labs, LLC

8501 Beck Road, Bldg 2227, Belleville, MI 48111 USA; 734-252-9785; joe@wrtest.com; http://www.wrtest.com

World Cal, Inc.

2012 High St., P.O. Box 410, Elk Horn, IA 51531 USA; 712-764-2197; Fax: 712-764-2195; gking@world-cal.com

Wurth Electronics Midcom Inc.

121 Airport Drive, Watertown, SD 57201 USA; 605-886-4385; Fax: 605-886-4486; lindsey.esche@we-online.com; www.we-online.com

Wyatt Technical Services LLC

56 Aspen Drive, Woodland Park, CO 80863 USA; (719) 310-5418; Fax: (719) 687-1428; Kenneth Wyatt, ken@emc-seminars.com; www.emc-seminars.com

Wyle

7800 Highway 20 West, Huntsville AL 35806 USA; 256-716-4587; Fax: 256-721-0144; Loren Traylor, loren.traylor@wyle.com; www.wyle.com

X

X2Y Attenuators LLC

2730-B W. 21st St., Erie, PA 16506 USA; 814-835-8180; Fax: 814-835-9047; www.x2y.com

Y

Yazaki Testing Center

6800 N. Haggerty Road, Catnion, MI 48187 USA; 734-983-6012; Fax: 734-983-6013; scott.lytle@us.yazaki.com; www.yazakiemc.com

York EMC Services Ltd.

Market Square, University of York, Heslington, York YO10 5DD United Kingdom; www.yorkemc.co.uk

Z

Zero Ground LLC 92

Main Sales Office: 3392 Hillside Court, Woodridge, IL 60517-1438 USA; 630-719-1900; 866-937-6463; Fax: 630-968-1200; panko@zero-ground.com; www.zero-ground.com

Zero Surge Inc.

889 State Route 12, Frenchtown, NJ 0 8825 USA; 908-996-7700; 800-996-6696; www.ZeroSurge.com

Zippertubing Company

13000 S Broadway, Los Angeles CA 90061 USA; 800-321-8178; 310-767-1714, Kira Carlston, info@zippertubing.com; www.zippertubing.com

Zuken

238 Littleton Road, Suite 100, Westford , MA 01886 USA; 978-692-4900; 800-356-8352; amy.clements@zuken.com; www.zuken.com

Update, add or edit your company's information in the EMC Buyers' Guide at www.interferencetechnology.com

INDEX OF ADVERTISERS

REQUEST INFORMATION FROM OUR ADVERTISERS
When you contact our advertisers, please remember to tell them you saw their ad in Interference Technology.

ADVANCED TEST EQUIPMENT RENTALS.....	50	KENSINGTON ELECTRONICS.....	77, 93
AGILENT TECHNOLOGIES.....	15	KIMMEL GERKE ASSOCIATES LTD.	27
AH SYSTEMS, INC.....INSIDE FRONT COVER,	17	LANGER EMV-TECHNIK GMBH.....	39
AR RF/MICROWAVE INSTRUMENTATION	7, 47	LCR ELECTRONICS.....	64
ARC TECHNOLOGIES.....	89	LIBERTY LABS.....	25
CAPTOR CORPORATION.....	79	MATERION BRUSH PERFORMANCE ALLOYS (FORMERLY BRUSH WELLMAN INC.).....	86
CPI- COMMUNICATIONS & POWER IND.....	49	MEGAPHASE LLC.....	72
CST-COMPUTER SIMULATION TECHNOLOGY.....	105	MESAGO MESSE FRANKFURT GMBH.....	119
CURTIS INDUSTRIES.....	76	MONTROSE COMPLIANCE SERVICES.....	27
DEXMET.....	93	MUSHIELD COMPANY.....	90
DNB ENGINEERING, INC.....	35	NARDA SAFETY TEST SOLUTIONS S.R.L.....	37
DON HEIRMAN CONSULTANTS.....	27	NAVAIR 5.4.4.5.....	9
EM SOFTWARE & SYSTEMS SA (PTY) LTD.....	107	NOISE LABORATORY CO., LTD.....	23
EM TEST USA.....	3	NTS - NATIONAL TECHNICAL SYSTEMS.....	1
EMC PARTNER AG.....	39	OPHIR RF.....	55
EMI FILTER COMPANY.....	75	PANASHIELD.....INSIDE BACK COVER	
ENR / SEVEN MOUNTAINS SCIENTIFIC.....	81	PEARSON ELECTRONICS, INC.....	52
ETC - ELECTRONICS TEST CENTRE.....	18	QUELL CORP.....	61
ETS - LINDGREN.....BACK COVER,	13	RADIOMETRICS MIDWEST CORP.....	38
FAIR-RITE PRODUCTS CORP.....	66	RADIUS POWER.....	65
FEDERAL-MOGUL CORPORATION.....	85	RETLIF TESTING LABORATORIES.....	33
FISCHER CONNECTORS.....	80	RFI CORPORATION.....	60
FISCHER CUSTOM COMMUNICATIONS, INC.....	41	SCHAFFNER EMC, INC.....	57
FOTOFAB CORP.....	91	SCHURTER INC.....	63
GORE.....	98, 99	SPECTRUM ADVANCED SPECIALTY PRODUCTS.....	71
HAEFELY EMC DIVISION.....	97	SPIRA MFG. CORP.....	87
HENRY OTT CONSULTANTS.....	27	SWIFT TEXTILE METALIZING.....	88
HOOLIHAN EMC CONSULTING.....	27	SYFER TECHNOLOGY.....	62
HV TECHNOLOGIES, INC.....	5	TDK EPC.....	59
IEEE 2012 PITTSBURGH.....	121	TECH-ETCH, INC.....	92
IFI INSTRUMENTS FOR INDUSTRY....	11, 28, 29, 54	TESEQ.....	21
INTEC LLC.....	69	TRI-MAG.....	73
INTERMARK USA.....	64	VTI VACUUM TECHNOLOGIES, INC.....	109
ITEM PUBLICATIONS.....	20, 31, 51, 67, 74, 95		

Facility Solutions for Global EMC

Let Panashield help you with your EMC facility project.

Our experienced personnel will provide technical support to guide you through the design, supply and certification of the following types of facilities:

- EMC Chambers
 - Compact, 3m, 5m, 10m
- RF Shielded Enclosures
- MRI Enclosures
- Military Test Chambers for 461E
- Avionics Test Chambers for DO160
- Free Space Simulation Chambers
- Reverberation Chambers
- P³ RF Sliding Doors
- Turnkey Services
- Facility Relocations
- Facility Upgrades

www.panashield.com



3 Meter EMC Chamber



Panabolt RF Shielding



10 Meter EMC Chamber



ets-lindgren.com/learning

Experience Hands-On Learning in a Lab

Get practical real-world training from experts!



ETS-U 2012 Class Schedule:

- EMC Fundamentals
Feb 14 – 16, May 22 – 24
- MIL-STD Testing
March 20 – 22, Oct 16 – 18
- Wireless Over-The-Air
Sept 18 – 20

Course Benefits:

- Classroom study with hands-on lab sessions
- Taught by experienced engineers
- Low student to instructor ratio
- Courses qualify for two CEU credits
- Course study guide included

Our training facilities include an A2LA accredited calibration lab, CTIA CATL, and NVLAP accredited acoustic lab.

For more information:

www.ets-lindgren.com/learning

Enabling Your Success™



An ESCO Technologies Company

www.ets-lindgren.com